

# An Investigation of the Switched-Capacitor Circuit as a Solid-State Fault Current Limiting and Interrupting Device (FCLID) with Power Factor Correction Suitable for Low-Voltage Distribution Networks

C. C. Marouchos  
Cyprus University of Technology/Electrical Engineering, Limassol, Cyprus  
christos.marouchos@cut.ac.cy

G. A. Putrus  
Northumbria University,  
Newcastle-uponTyne  
NE18ST, U.K  
gha-nim.putrus@unn.ac.uk

M. Darwish  
Brunel University/School of  
Engineering and Design, London, UK  
Mohamed.Darwish@brunel.ac.uk

F. Paterakis  
Technological Educational  
Institute of Athens, Dep. of  
Electronic Engineering,  
Greece,fpatera@teiath.gr

**Abstract**— The Switched Capacitor (SC) Circuit is investigated in this paper as a Solid-State Fault Current Limiter and interrupting device (FCLID) with power factor correction suitable for low-voltage distribution networks. It was applied so far successfully as a power factor and harmonic current compensator and as a Switched Capacitor Circuit inverter. In this application it is inserted in series with the supply line, providing both power factor correction and limitation of the current to a pre-set value in the event of a fault. Interruption of the fault is also possible by setting both semiconductor switches in the off state. Overvoltage is present in SC Circuits and they appear across both the passive and active components. The problem can be alleviated by optimising the system operation and system components.

**Index Terms**— Switched Capacitor, Duty Cycle, Power factor, Current limiter, Distribution network

## I. INTRODUCTION

Fault current limiting and interrupting can only be achieved by inserting a device in series with the line [1]. In this way the level of the fault current is limited to a safe value for the circuit breakers to perform the interruption. Thus the rating of the transformers, circuit breakers (CBs), buses and other electric equipment at fault current is lower.

Solid State switches are used together with reactors [2]. LC tuned circuits [3] in Fault Current Limiters. An isolating transformer [4]-[5] option providing flexibility in the choice of the VI ratings of the components used is also an option, Fig. 4.

The impedance of the Switched Capacitor (SC) Circuit can be set either inductive or capacitive at any value by setting the duty cycle of the semiconductor switches, Fig. 2. In the past it was employed for power factor correction [6] and for harmonic current compensation [7].

In this application, the Switched Capacitor circuit offers the capacitive series impedance during normal operation in order to either make the power factor unity or just improve it. The fact that the power factor correction takes place in series Fig. 3, gives rise to the load voltage, Fig. 5. During a fault the

impedance of the SC capacitor circuit can be set at any value in order to limit the current to a safe and predetermined value.

Compensation of the power factor is done by adjusting the impedance of the SC Circuit to match the impedance of the load. Specifically since most of the loads are inductive, the reactance of the SC circuit is set capacitive at a value to set the power factor at any value including unity.

The entire load current flows through the passive and any active components of the Fault Current Limiter. In the case of the SC Circuit, the full load current flows through the semiconductor switches, the capacitor and the inductor giving rise to a high voltage across the capacitor and losses. The various results for all cases were obtained through PSIM simulations.

## II. THE SWITCHED CAPACITOR CIRCUIT AS A CURRENT LIMITER AND POWER FACTOR COMPENSATOR

### A. The switched capacitor circuit

The semiconductor switches in a switched capacitor circuit are working in antiparallel Fig. 1. The current is diverted from  $S_2$  to  $S_1$  and through the capacitor. In this way the total impedance of the switched capacitor circuit can be set either zero, capacitive or inductive and anything in between by setting the duty cycle of the switch  $S_1$ , Fig. 2.

The impedance of the circuit as a function of the duty cycle of the semiconductor switch  $S_1$  is derived according to [6] and [8] as

$$Z(K_o) = \sqrt{r^2 + \left( \omega L - \frac{K_o^2}{\omega C} \right)^2} \quad (1)$$

Where  $K_o$  is the duty cycle of  $S_1$ ,  $r$  represents the ohmic resistance of the passive components and semiconductor switches,  $\omega$  is the mains frequency,  $L$  and  $C$  are the values of the inductor and the capacitor in Fig. 1.

The impedance  $Z$  of Fig. 1, is set according to (1) by the values of  $L$ ,  $C$  and  $K_o$ . For  $L = 0.05$  and  $H = 40\mu F$ , it is inductive for values of  $K_o$  less than 0.444 and capacitive for values

of  $K_o$  above 0.444 as shown in Fig. 2. Resonance is also possible at  $K_o = 0.444$  where the impedance of the circuit is reduced to the small ohmic resistance  $r$ .

An obvious application of this circuit is as a power factor compensator [6].

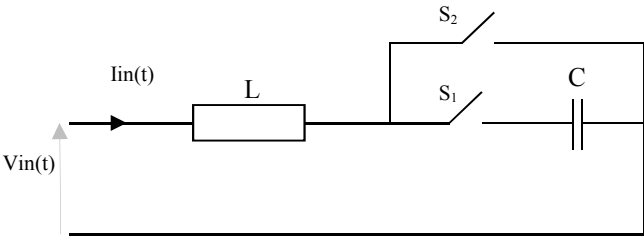

Fig. 1. The switched Capacitor circuit.

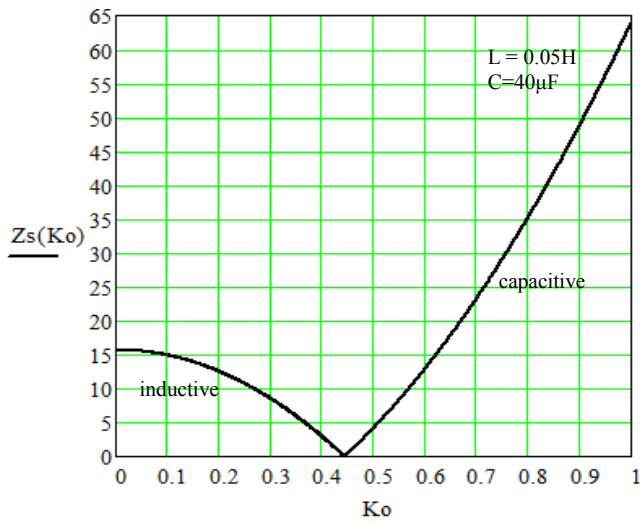

Fig. 2. Impedance of the switched capacitor circuit against  $K_o$ , the duty cycle of the switch  $S_1$ .

**B. The switched capacitor circuit as a current limiter and power factor compensator**

In this application the switched capacitor circuit is inserted in series with the load Fig. 3, providing power factor correction and in the event of a fault it limits the current to a pre-set value. Interruption of the fault is also possible by setting both semiconductor switches  $S_1, S_2$  in the off state. An isolating transformer [5]-[7] option providing flexibility in the choice of the VI ratings of the components used is also an option, Fig. 4.

The load consists of a  $4\Omega$  resistor and  $0.01H$  giving a load power factor of 0.786 and a line current of 56A. The SC Circuit inductance and capacitance are set in the first instance at  $0.05H$  and the capacitor is  $40\mu F$ . Later on, another set of  $L$  and  $C$  values is employed in order to control the voltage across the capacitor and the switches.

In normal operation the SC circuit is acting as a power factor corrector. The inductive impedance of the load is matched to the impedance of the SC circuit by choosing the appropriate value of the duty cycle  $K_o$ .

Specifically, the load reactance is  $3.142\Omega$ . In order to make the power factor unity the SC circuit must provide

$3.142\Omega$  capacitive reactance. This is done by setting the duty cycle of the switch  $S_1$  in Fig. 3, to 0.4867 according to (1). Alternatively it can be read from Fig. 2. The general vector diagram is shown in Fig. 5. Fig. 6a, displays the current vector uncompensated at a power factor of 0.786 and in Fig. 6b, compensated at unity power factor. As expected the voltage across the load will rise with the power factor correction.

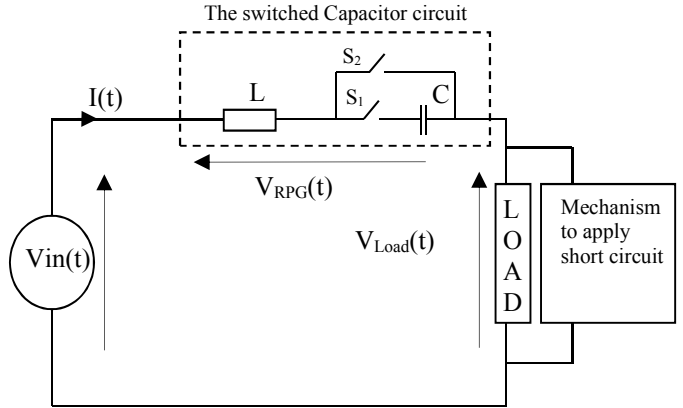

Fig. 3. The power circuit of the SC current limiter and power factor compensator.

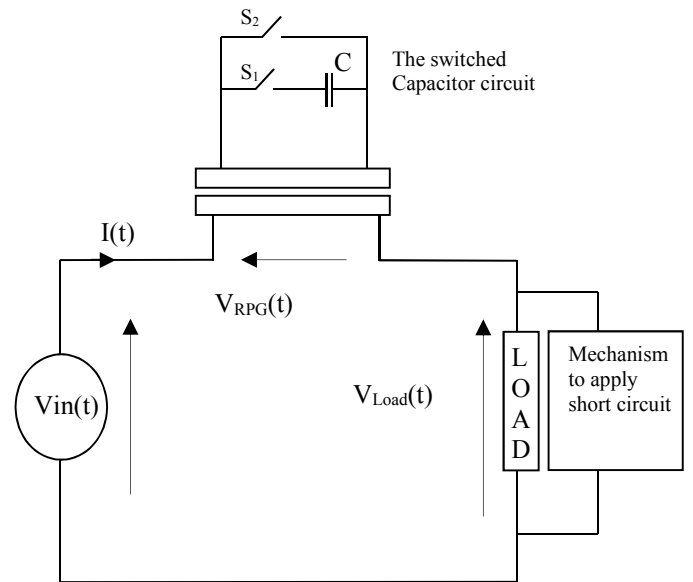

Fig. 4. The power circuit of the SC current limiter and power factor compensator with isolating transformer.

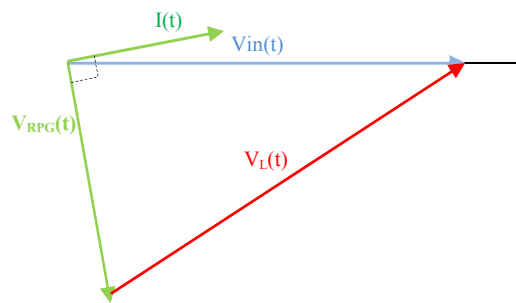

Fig. 5. Vector diagram for setting the power factor.

In the event of a fault there is the impedance of the SC Circuit of  $3.142\Omega$  (Case A) to limit the current, Fig. 7a. As shown at the beginning of the fault ( $t = 1s$ ) the current increases from 50A to 125A but it decays quickly to 45A in less than a second. The final value of the current will be set by the SC Circuit  $3.142\Omega$  impedance. The presence of the fault can be sensed by observing the frequency spectrum of the fault current, Fig. 7b. A strong 59Hz harmonic appears during the fault.

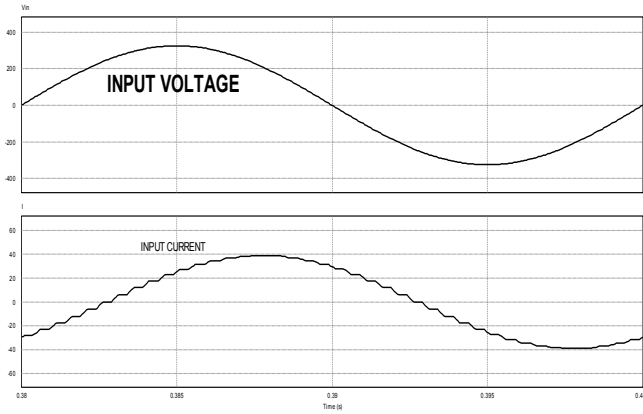

Fig. 6a. The line current uncompensated  $pf=0.623$ .

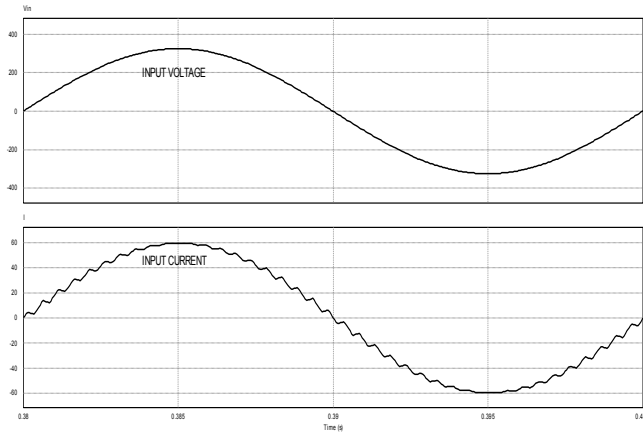

Fig. 6b. The line current compensated  $pf= 1$ .

The reaction of the circuit to a fault is tested further by inserting the full capacitive reactance of the SC Circuit (Case B) one cycle after the occurrence of the fault. This is the reactance of the  $40\mu F$  capacitor,  $79.6\Omega$ . Fig. 8a, displays the current before and during the fault with its maximum value rising to 118A. The insertion of the  $79.6\Omega$  reactance is achieved by setting the duty cycle  $K_o$  of the semiconductor switch  $S_1$  to one as dictated from (1) and Fig. 2. The fault current eventually decays to a value dictated by the  $79.6\Omega$  reactance i.e. 4A. A strong presence of a 112Hz harmonic Fig. 8b, is observed during the fault.

Finally the circuit is tested by inserting the full inductive reactance  $22\Omega$  of the circuit (Case C) one cycle after the occurrence of the fault, Fig. 9a. It is raising the current to 142A with a strong decaying dc component, Fig. 9b. The fault current eventually decays to a value dictated by the  $22\Omega$  reactance i.e. 14.8A. The insertion of the  $22\Omega$  reactance is ac-

commodated by setting the duty cycle of the switch  $K_o$  to zero as dictated by (1).

Furthermore, interruption of the fault is possible at any point by switching off both switches  $S_1, S_2$ . Of course the fault current can be set to any value by adjusting  $K_o$  accordingly.

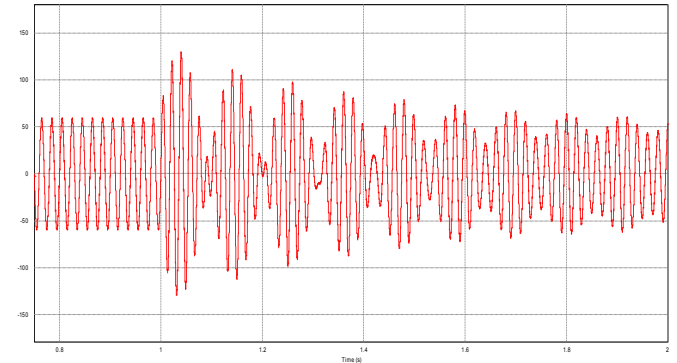

Fig. 7a. Current during fault conditions Case A: No action.  $L = 0.05 C = 40\mu F$

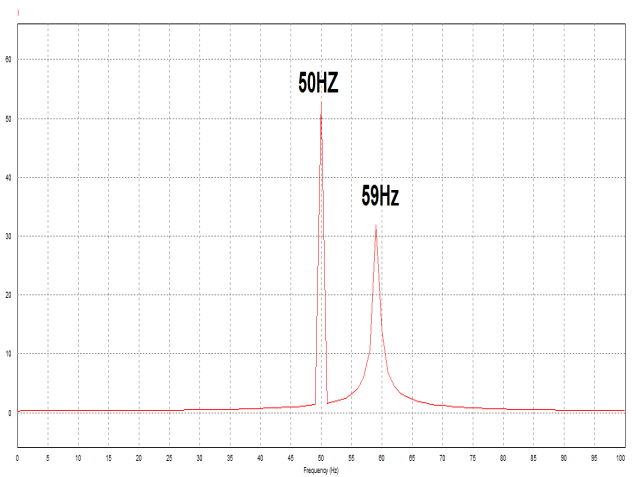

Fig. 7b. Frequency Spectrum of the current during fault conditions Case A: No action.  $L = 0.05 C = 40\mu F$

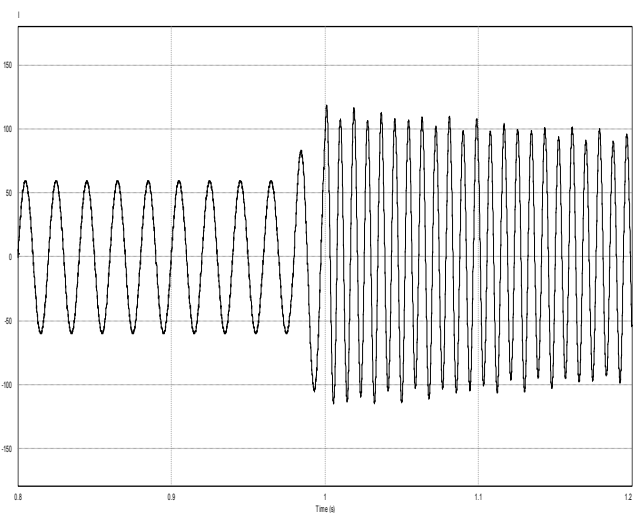

Fig. 8a. The current during fault conditions Case B: Maximum impedance-capacitive.  $L = 0.05 C = 40\mu F$

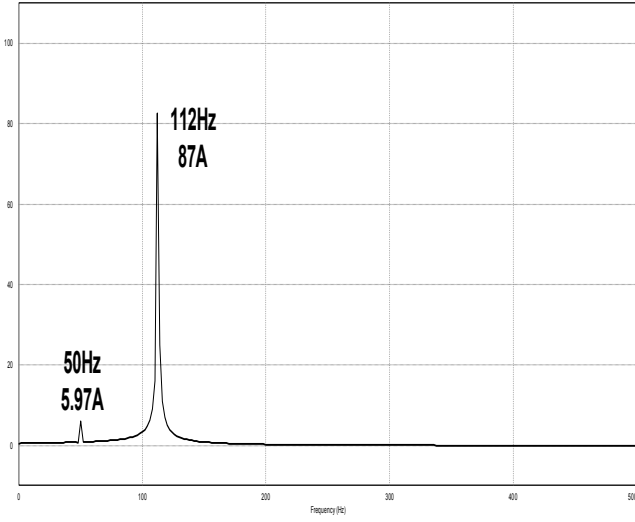

Fig. 8b. Frequency Spectrum of the current during fault conditions Case B: Maximum impedance-capacitive.  $L = 0.05$   $C = 40\mu\text{F}$

### C. Ratings of components of the switched capacitor and optimization.

The SC circuit is characterized by overvoltage phenomena across both the passive and active components, Fig. 10. The voltage across the capacitor and hence the semiconductor switches is easily derived for the fundamental component by considering the current entering the switched capacitor as the ratio of the supply voltage  $V$  to the impedance and the fact that the current (2) entering the capacitor is determined by the duty cycle  $K_o$  of  $S_1$  [8]. Hence the voltage across the capacitor and the switches is given by (3)

The current entering the capacitor is

$$I_c(t) = \frac{V}{\sqrt{r^2 + \left(\omega L - \frac{K_o^2}{\omega C}\right)^2}} K_o \quad (2)$$

The voltage across the capacitor is

$$V_c(t) = \frac{V}{\sqrt{r^2 + \left(\omega L - \frac{K_o^2}{\omega C}\right)^2}} K_o \frac{1}{\omega C} \quad (3)$$

During normal operation when the SC Circuit is performing only power factor correction the voltage across the capacitor and hence the semiconductor switches can be much higher than the supply voltage, Fig. 10. This is basically determined by the  $L/C$  ratio. As shown in Fig. 10, there is a dramatic reduction of this voltage for lower ratios. For a 56A load and power factor at 0.786, if unity pf correction is needed, utilizing high  $L/C$  ratio where,  $L=0.05\text{H}$  and  $C=40\mu\text{F}$ , the voltage across the capacitor is raised to 2920V given by (3), a voltage which is very high. This is decreased to 686V by a lower  $L/C$  ratio where,  $L = 0.005\text{H}$  and  $C=200\mu\text{F}$ . The voltage

across the capacitor and switches can be reduced further if a power factor less than unity is acceptable, Fig. 5. The capacitor voltage can be reduced by 30% and still retain a pf of 0.9 leading.

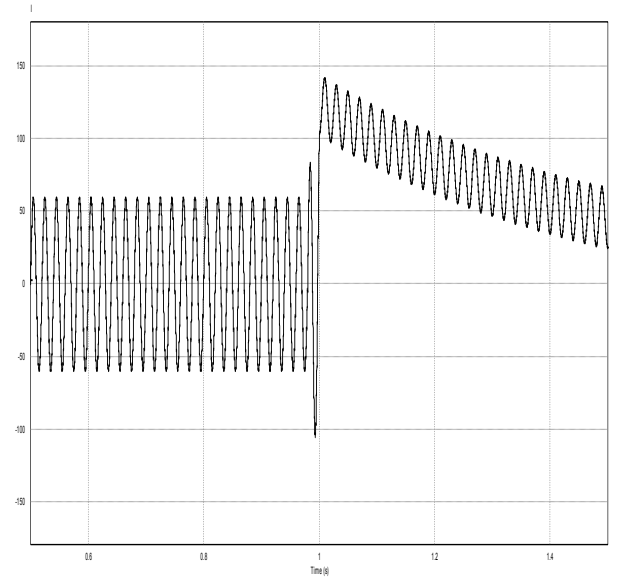

Fig. 9a. The current during fault conditions Case C: Maximum impedance-inductive.  $L = 0.05$   $C = 40\mu\text{F}$

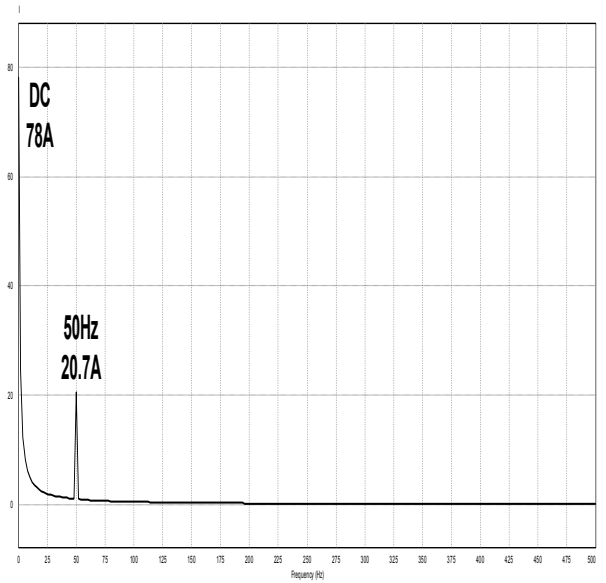

Fig. 9b. Frequency Spectrum of the current during fault conditions Case C: Maximum impedance-inductive.  $L = 0.05$   $C = 40\mu\text{F}$

From the load side, the output voltage is increased because the power factor is compensated in series, Fig. 5. Specifically, with the high ratio of  $LC$  ( $L = 0.05\text{H}$   $C=40\mu\text{F}$ ) the output voltage is raised to 274V but reduced to 248V by setting the lower  $L/C$  ratio with power factor of 0.9 leading. Therefore with proper optimisation the output voltage is expected to be within acceptable limits. Under these conditions with leading power factor the SC Circuit is also providing leading KVA to the grid. Further optimization is possible.

More options to the designer are offered by employing the circuit of Fig. 4, where a transformer is used to connect the SC circuit to the network. The leakage inductance of the transformer can be utilized to replace the inductor L in the power circuit of Fig. 3. Its turn ratio can be arranged to accommodate the voltage ratings of the capacitor and the semiconductor switches.

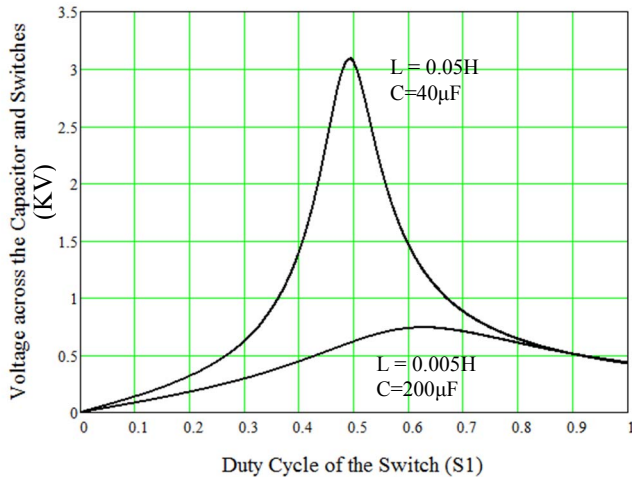

Fig. 10. Voltage across the capacitor (KV) as a function of  $K_o$ .

### III. DISCUSSION

The SC Circuit is employed in a new application to correct both the pf and at the same time it is a solid-state fault current limiting and interrupting device (FCLID) for low voltage distribution networks. The SC circuit is inserted in series with the power line and its current limiting ability lies in the fact that its impedance is smoothly controlled by the duty cycle of its switches,  $K_o$ . For power factor correction the reactive impedance of the load is compensated by the impedance of the SC circuit.

The ability of the circuit to control the fault lies in the fact that there is always the reactive impedance of the SC Circuit in series with the line at the connection point. While this circuit can be used in low-voltage (LV) systems as well, at this stage no consideration has been taken to costs.

Since, this limiter is not in practical use yet the circuit is tested through PSIM simulation under three conditions. In the first case in the event of the fault no action is taken and the current first rises from 50A to 125A and quickly decays to 45A within one second. In the second case the full impedance of the SC circuit  $79.6\Omega$  is inserted with the current first rising from 50A to 118A and quickly decays towards 4A. In a final test the full inductive  $22\Omega$  reactance of the SC circuit is inserted and the current first rises from 50A to 142A and quickly decays towards 14.8A. In all three cases the value of the duty cycle  $K_o$  of the switch  $S_1$  is set accordingly. Actually the series impedance of the SC circuit can be set to any value in order to keep the current with any preset limits value by selecting the appropriate value of  $K_o$ . The presence of a fault can be detected from the strong 59Hz harmonic in the fault

current. Of course the frequency and magnitude of the harmonic depends on the values of LC.

A drawback of this proposition is the fact that both the semiconductor switch and the capacitor can be subjected to a voltage higher than the supply. It was shown though that this becomes manageable by selecting a lower L/C ratio and further reduction is possible by adopting a lower but leading power factor than unity. Further optimization is possible by employing a transformer to connect SC to the line.

Another disadvantage is the increase of the load voltage when the SC is performing power factor correction. It might be an advantage in areas where the grid voltage is low but this does not happen always. Adopting a leading power factor less than unity (0.9) can reduce it by 35%.

The switching frequency of the semiconductor switches  $S_1$  and  $S_2$  sets the voltage harmonics across the load. For this reason the switching frequency must be optimized with the size of the passive filter against the switching losses.

### REFERENCES

- [1] M. M. R. Ahmed, G. Putrus, Li Ran and R. Penlington, "Development of a prototype solid-state fault-current limiting and interrupting device for low-voltage distribution networks," in IEEE Transactions on Power Delivery, vol. 21, no. 4, pp. 1997-2005, Oct. 2006.
- [2] Radmanesh, S.H.Fathi, and G.B.Gharehpetian, "Novel high performance DC reactor type fault current limiter," *Elect. Power Syst. Res.*, vol. 122, pp. 198-207, May 2015.
- [3] H. Radmanesh, S. H. Fathi, G. B. Gharehpetian and A. Heidary, "A Novel Solid-State Fault Current-Limiting Circuit Breaker for Medium-Voltage Network Applications," in IEEE Transactions on Power Delivery, vol. 31, no. 1, pp. 236-244, Feb. 2016.
- [4] A. Abramovitz and K. Ma Smedley, "Survey of Solid-State Fault Current Limiters," in IEEE Transactions on Power Electronics, vol. 27, no. 6, pp. 2770-2782, June 2012.
- [5] Seyed Behzad Naderi, Mehdi Jafari, Mehrdad Tarafdar Hagh, "Controlable resistive type fault current limiter (CR-FCL) with frequency and pulse duty-cycle, *International Journal of Electrical Power & Energy Systems*, Volume 61, October 2014, Pages 11-19, ISSN 0142-0615
- [6] C. Marouchos, M. K. Darwish and M. El-Habrouk, "Variable var compensator circuits," in IEE Proceedings - Electric Power Applications, vol. 153, no. 5, pp. 682-690, September 2006.
- [7] C. C. Marouchos, M. Evdokimou and M. Darwich, "Application of the switched capacitor compensator in closed loop," 2014 49th International Universities Power Engineering Conference (UPEC), Cluj-Napoca, 2014, pp. 1-5.
- [8] C. C. Marouchos, "The Switching Function: analysis of power electronic circuits," in *Circuits, Devices and Systems Series 17*, London: Institution of Engineering and Technology, 2008.