



Review

A review on long-term electrical power system modeling with energy storage

Chun Sing Lai ^{a, b, c}, Giorgio Locatelli ^{a, *}, Andrew Pimm ^d, Xiaomei Wu ^b, Loi Lei Lai ^{b, **}^a School of Civil Engineering, Faculty of Engineering and Physical Sciences, University of Leeds, Leeds, LS2 9JT, UK^b Department of Electrical Engineering, School of Automation, Guangdong University of Technology, Guangzhou, 510006, China^c Brunel Institute of Power Systems, Department of Electronic and Computer Engineering, Brunel University London, London, UB8 3PH, UK^d Low Carbon Energy Research Group, School of Chemical and Process Engineering, Faculty of Engineering and Physical Sciences, University of Leeds, Leeds, LS2 9JT, UK

ARTICLE INFO

Article history:

Received 25 February 2020

Received in revised form

14 September 2020

Accepted 16 September 2020

Available online 23 September 2020

Handling editor: Prof. Jiri Jaromir Klemes

Keywords:

Electrical power system model

Generation-integrated energy storage

Energy storage

Economics

ABSTRACT

Driven by the demand for intermittent power generation, Energy Storage (ES) will be widely adopted in future electricity grids to provide flexibility and resilience. Technically, there are two classes of ES for storing low-carbon energy: Generation-Integrated Energy Storage (GIES) and non-GIES. GIES stores energy along with the transformation between the primary energy form (e.g., thermal energy) and electricity. Long-term Electrical Power System Models (LEPSMs) support analysis including decarbonization studies and energy technology assessments. Current LEPSMs are limited in describing the power system with ES (e.g., considering one type of ES and not considering GIES). Consequently, a novel LEPSM is needed, and this paper paves the way towards this goal by bringing together the literature on ES and LEPSMs. This paper provides a state-of-the-art review of LEPSMs and shows that (a) existing models are inadequate to address grids with a high percentage of renewables and ES; and (b) there is a challenge in integrating short-term temporal changes in LEPSMs due to model complexity and computational cost. Finally, this paper proposes a framework for long-term electrical power system modeling considering ES and low-carbon power generation, which we have named the long-term power flow electrical power system framework. The key features of this novel framework are its agent-based modeling of consumer behavior, scenario reduction for renewables, and power flow analysis.

© 2020 The Authors. Published by Elsevier Ltd. This is an open access article under the CC BY license (<http://creativecommons.org/licenses/by/4.0/>).

Contents

1. Introduction	3
2. Methodology	3
2.1. Identifying literature	3
2.2. Mapping content	4
3. ES for low-carbon power generation	4
3.1. Types of ES	4
3.2. Emerging non-electrochemical ES	4
3.3. Hybrid ES and generation	5
3.4. GIES	5
4. Electrical power system planning and operation	7
4.1. Long-term electrical power system models	7
4.2. Capacity expansion and production cost integrated LEPSMs	9

* Corresponding author.

** Corresponding author.

E-mail addresses: chunsing.lai@brunel.ac.uk (C.S. Lai), g.locatelli@leeds.ac.uk (G. Locatelli), a.j.pimm@leeds.ac.uk (A. Pimm), epxm_wu@gdut.edu.cn (X. Wu), l.l.lai@ieee.org (L.L. Lai).

<https://doi.org/10.1016/j.jclepro.2020.124298>

0959-6526/© 2020 The Authors. Published by Elsevier Ltd. This is an open access article under the CC BY license (<http://creativecommons.org/licenses/by/4.0/>).

5. Three modeling aspects for LEPSM improvement 10
 5.1. Renewable generation scenarios 10
 5.2. ABM of energy consumer behavior 11
 5.3. LCOE for intermittent renewables and ES 12
 6. A novel framework for long-term electrical power system modeling 13
 6.1. Agent-based and power flow model integration 15
 6.2. A two-stage scenario and multi-objective optimization framework 15
 6.3. Renewable uncertainties and cost implications for ES systems 16
 7. Discussion 16
 8. Conclusions 18
 Declaration of competing interest 18
 Acknowledgements 18
 References 18

Nomenclature		UWCAES	Underwater Compressed Air Energy Storage
		Wind-TP	Wind-Thermal Pumping
<i>Abbreviations</i>		<i>Symbols</i>	
ABM	Agent-based Modeling	δ, γ, α	Quadratic constants for EM_{Total}
AC	Alternating Current	θ	Voltage angle (Degrees)
BDA	Big Data Analytics	a	Factor for relative importance of economic and social factors
CAES	Compressed Air Energy Storage	B	Susceptance (Siemens)
CEM	Capacity Expansion Model	d	Discount rate (%)
CF	Capacity Factor	E	Energy consumption economic factor
CSP	Concentrated Solar Power	f_1	System's LCOE (\$/kWh)
DC	Direct Current	f_2	Total carbon dioxide emissions (kgCO ₂)
ES	Energy Storage	f_3	System energy index of reliability
EV	Electric Vehicle	G	Conductance (Siemens)
FES	Flywheel Energy Storage	EM_{Total}	Total emissions contribution (kgCO ₂)
GE	General Electric	i	Agent number
GIES	Generation-Integrated Energy Storage	j	and k Busbar number
IEA	International Energy Agency	n	Year
LAES	Liquid Air Energy Storage	O	Cost of energy storage (\$/kW)
LCOE	Levelized Cost of Electricity	P	Real power (kW)
LEAP	Long-range Energy Alternatives Planning system	P_{Actual}	Actual power consumption (kW)
LEPS	Long-term Electrical Power System	$P_{Effective}$	Effective power (kW)
LEPSF	Long-term power flow Electrical Power System Framework	$P_{ES_{Min}}$	Permissible minimum energy storage power (kW)
LEPSM	Long-term Electrical Power System Model	P_{ES}	Energy storage power (kW)
LTS	Latent Thermal Storage	P_{Load}	Load power (kW)
MAPS	Multi Area Production Simulation	P_{Rated}	Peak power demand (kW)
NEMS	National Energy Modeling System	P_{Supply}	The power supply for the system (e.g., ES, import power, and generators) (kW)
NREL	National Renewable Energy Laboratory	P_{Total}	The total power delivered by all generators (kW)
PCM	Production Cost Model	Q	Reactive power (kVAr)
PSH	Pumped Storage Hydropower	S_u	Cardinality of the cluster
PTES	Pumped Thermal Energy Storage	t	Hour
PV	Photovoltaic	u	Cluster number
R&D	Research and Development	V	Voltage magnitude (per unit)
ReEDS	Regional Energy Deployment System	w_1, w_2, w_3	Weighting factors
REMix	Renewable Energy Mix	X	Binary variable to represent whether the demand is completely met by supply
RPM	Resource Planning Model	Z	Factor for social influence impacts on energy consumption behavior
STS	Sensible Thermal Storage		
SMES	Superconducting Magnetic Energy Storage		
THS	Thermochemical Thermal Storage		

1. Introduction

To achieve a low-carbon economy, the penetration of non-dispatchable renewables in electrical power systems needs to be increased over the coming decades (Lai et al., 2017a). Energy Storage (ES) is becoming increasingly important in providing energy and power balancing for the grid. However, installed ES capacity is still very limited (but rapidly growing) as compared with power generation capacity (Energy storage).

Liu and Du (Liu and Du, 2016) claimed that there is a significant technical impact for preserving the demand and supply balance of renewable energy and minimizing energy costs by selecting the right ES technology. ES technologies have dissimilar capital, safety, and technology risks due to their different technical complexity. Liu and Du (Liu and Du, 2016) proposed a multi-criteria decision support framework for ES technology selection based on group decision-making perspectives. They also noted that there are greater risks for the ES system when many types of ES technologies are integrated. Thus, determining the optimal ES technology mix when accounting for multidimensional risks is an ongoing challenge.

Technically, there are two main categories of ES for storing low-carbon energy: Generation-Integrated ES (GIES) and non-GIES (Garvey et al., 2015a). GIES is ideal for storing a large amount of energy at some point along the transformation between the primary energy form (e.g., the kinetic energy in wind) and electricity (Garvey et al., 2015a). GIES typically consists of novel ES and power generating technologies, including the integrated wind power generator with compressor and pumped thermal energy storage (Garvey et al., 2015b; Smallbone et al., 2017).

Non-GIES directly converts the primary energy into electricity for storage, such as a permanent magnet synchronous generator for wind energy with electrochemical ES (Xia et al., 2018). Non-GIES is a more common form of ES due to the technological maturity of various batteries (e.g., Lithium-ion and redox flow) (Lai et al., 2017a).

Long-term Electrical Power System Models (LEPSMs) need to acknowledge the differences between ES technologies and energy production methods for credible planning of low-cost, clean, and secure power systems. Traditionally, LEPSMs have been designed to model scenarios dominated by a dispatchable plant, while future scenarios will have large proportions of variable/inflexible generation and ES. A new LEPSM is needed for system planners and government agencies to promote technologies and policies.

Driven by the above challenges and the existing gap in knowledge, this paper provides the following contributions:

1. A review of emerging ES technologies.
2. Categorization of ES technologies based on the two typical configurations (GIES and non-GIES) and how ES can affect the power grid from the techno-economic perspective.
3. A critical review of existing LEPSMs, highlighting the key challenges and research opportunities in respect to high penetrations of ES and low-carbon power generation.
4. Description of an LEPSM considering: A) intermittent electricity production from renewable sources, B) unpredictable electricity consumption, C) the role of GIES and non-GIES, and D) long-term electrical power system optimization.

The rest of the paper is organized as follows. Section 2 presents the methodology for selecting the literature to conduct the review. Section 3 reviews the emerging ES and GIES systems for low-carbon power generation. Section 4 reviews the operational and planning modeling techniques for electrical power systems and long-term electrical power system studies with ES. Section 5 introduces

three areas that are of significance in LEPSMs. These are renewables scenario reduction, Agent-based Modeling (ABM) of energy consumption, and Levelized Cost of Electricity (LCOE). The novel framework for long-term electrical power system modeling is described in Section 6, which provides enhanced planning and scheduling capabilities for electrical power systems featuring high penetrations of low-carbon power generation and ES. Finally, discussion and conclusions are given in Sections 7 and 8, respectively.

2. Methodology

The method used in the literature review consisted of two steps:

- (i) Identifying the literature to review by a search in databases and [Google.com](https://www.google.com) combined with a set of rules for selecting the relevant pieces of literature. Some LEPSMs and ES technologies may not be published in databases if they are developed by a business or other commercial enterprise.
- (ii) Mapping the content of the reviewed literature by extracting information using a set of questions which identifies the aspects for LEPSM modeling improvements.

The method is described in the following sections.

2.1. Identifying literature

As this work focuses on electrical power system modeling with generation-integrated ES, three classes of literature were identified. We searched for literature in the Scopus, Science Direct, and Google Scholar databases using the following Boolean search string:

For generation-integrated energy storage technologies (Section 3): (Novel AND energy storage) OR "Generation integrated energy storage" OR "energy storage" AND (wind OR solar OR coal OR nuclear fission OR concentrating solar power OR photovoltaic OR hydro).

For long-term power and energy system modeling (Section 4): (Long-term AND electricity system) OR "energy system modeling" OR "power system modeling."

For energy and power system with energy storage (Sections 3 and 4): ("Energy storage" OR (long-term AND energy system)) OR ("generation integrated energy storage" AND long-term AND energy system) OR ("energy storage" AND power system) OR ("generation integrated energy storage" AND power system).

To select a relevant and manageable set of studies among the identified pieces of literature, we established the following selection rules:

Inclusion of studies:

- From journals, conference proceedings, organization reports, and software manuals available on the internet
- On any categories of energy-related sectors (i.e., transport, heat, and electricity)
- Any geographical scope (i.e., energy study could be related to one region or country)

Exclusion of studies:

- "Battery" and "electro-chemical energy storage systems" as the review focuses on GIES
- Top-down ES models. These models are based on macroeconomics and are not within the scope of this paper where technology is the focus
- In languages other than English (English is widely used by academics and professionals)

- In duplicates (e.g., if a work is an extended version of a prior work, then the extended version is considered)
- Of unrecognizable source or non-peer reviewed works, as credibility can be challenged

2.2. Mapping content

The following questions drove the literature review process and identified the information to be extracted:

- Which electrical power system problems does the model aim to answer (e.g., planning or operation)?
- What is the timeframe considered in the modeling (e.g., hours or years)?
- What is the geographical scope (e.g., national or regional)?
- What are the output indicators of the model (e.g., economic or technical)?
- Which ES technologies are considered in the electrical power system model?
- What are the current emerging ES technologies for GIES?
- Which GIES technologies are mature?
- What are the conclusions from the work and suggested improvements?

3. ES for low-carbon power generation

This section presents a review of the usage and types of grid ES technologies, with a focus on GIES.

3.1. Types of ES

There are several types of ES. Luo et al. (2015) provided a comprehensive review of the economic and technical properties of ES technologies. Amirante et al. (2017) gave an overview of the following: mechanical systems (Compressed Air ES [CAES], Pumped Storage Hydropower [PSH], and Flywheel ES [FES]); electrical systems (supercapacitors and superconducting magnetic ES [SMES]); electrochemical systems (lead-acid batteries, Lithium-ion batteries, and flow batteries); and hydrogen ES. The overview concluded that PSH and CAES systems provide low costs of ES capacity when

installed on a large-scale and have long discharge times and high-power ratings. FES systems provide very high power but have relatively low storage capacities. Hydrogen ES, especially with clathrate hydrates and carbon nanotubes, is still in the development stage. For electrochemical ES, flow batteries have the benefit of decoupled power and ES capacities, so both capacities can be adjusted relatively easily. Flow batteries have experienced numerous technological breakthroughs and are expected to be commercialized soon (Lai et al., 2017a; Lai and McCulloch, 2017). Lithium-ion is experiencing plummeting costs (Lai et al., 2017a; Trainer, 2017), but there is still a major concern with the available service life due to cell degradation and mining of metals including lithium and cobalt (Lai et al., 2017; Lai et al., 2019a; Lai et al., 2018).

Energy transformation is a critical subject for ES, Fig. 1 depicts the relationship between the low-carbon power generation sources, energy conversion processes, and subsequent possible GIES technologies. Chemical energy can be transformed into thermal energy via combustion or other reactions, thermal energy can be transformed into kinetic energy via a heat engine, and kinetic energy can be converted to electricity via an electrical generator. Also, thermal energy can be converted to electricity via a thermoelectric generator. However, at 8% efficiency, such generators are too costly to be used in high power applications (Chen et al., 2016).

3.2. Emerging non-electrochemical ES

Various non-electrochemical energy storage technologies are in the Research and Development (R&D) stage, and the most relevant are the following.

FES relies on angular kinetic energy for ES. Most FES systems use an electric motor to accelerate and decelerate the flywheel. Research is ongoing to develop flywheel systems that reduce losses associated with electrical-mechanical energy conversion, such as the continuously variable transmission system (Dhand and Pullen, 2015; Mangialardi and Mantriota, 1992).

Underwater CAES (UWCAES) is derived from conventional CAES but takes advantage of the hydrostatic pressure in deep seawater. If deep water (several hundred meters deep) is close enough to land that the turbomachinery can be located onshore, then UWCAES can be a cost-effective ES technology (Pimm et al., 2014). Pimm et al. (2011) presented a methodology to determine the optimal shape

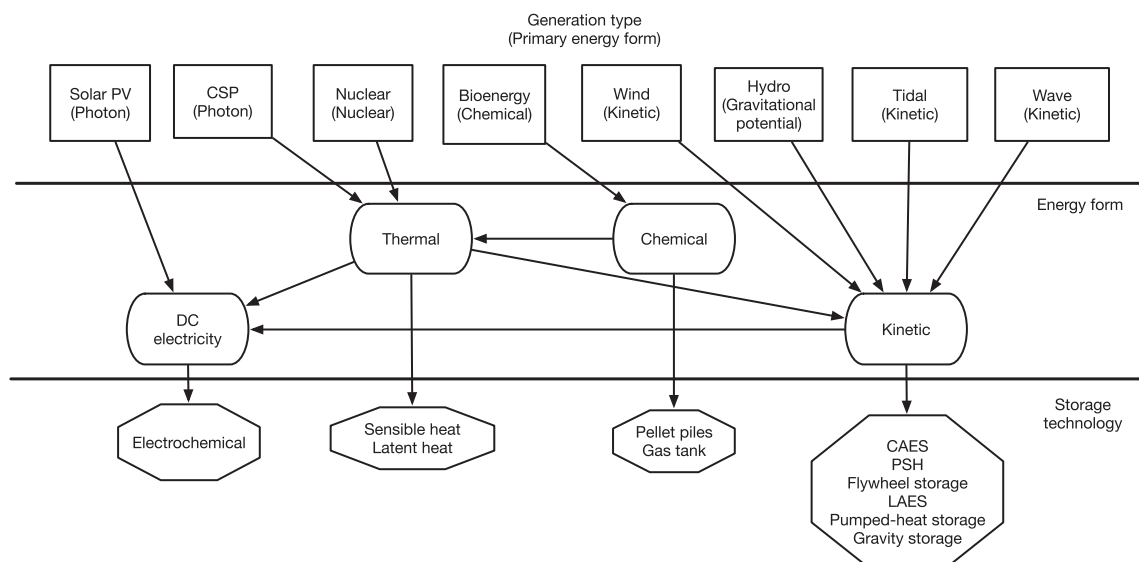

Fig. 1. Energy transformation processes between low-carbon power generation and possible generation-integrated energy storage technologies.

and cost of energy bags (cable-reinforced fabric vessels). With the possibility for large-scale deployment, detailed techno-economic analysis is required (Pimm et al., 2011).

Gravity ES is a set of ES technologies that involve moving liquids or other large masses upwards against the force of gravity. There are various forms of gravity ES in development, including a concept with a water-filled container, typically in an excavated hole in the ground, and a heavy piston (Berrada et al., 2017a, 2017b; Benato and Stoppato, 2018). When electricity is needed, the piston is allowed to move downwards, forcing water through the turbine. Gravity storage has low self-discharge, good round-trip energy efficiency at ~80%, long life span, high power density, and fast response times. Berrada et al. (2017b) developed an optimal sizing method for gravity ES to optimize the technical and economic factors, and they found that gravity ES can be competitive with other ES technologies.

Sensible Thermal Storage (STS), traditionally paired with Concentrated Solar Power (CSP), applies to heat-based sustainable generation such as nuclear power plants (Zhao et al., 2018), and can be used to enhance the controllability of fossil fuel plants (Garbrecht et al., 2017). Li (2016) gave a comprehensive review of STS. STS has low operational cost and good stability, typically using materials such as water, gravel, or oil, but it also has low energy density. One of the current challenges is to develop a molten salt mixture that gives excellent thermal storage and transfer without degradation (Wu et al., 2018). Further research is also needed on the cost and charging/discharging performance of energy systems using STS (Li, 2016; Iranzo et al., 2018). Ghorbani et al. (2020) performed an exergy and energy analysis of a wind power system with CAES and multi-stage phase change material. They found that phase change material has excellent thermo-physical properties, providing high energy density with a low temperature gradient between the storing and recovering of energy. Exergy analysis demonstrated that about 60% of exergy destruction happened in the phase change material. The round-trip efficiency can reach up to 80.71% for the proposed ES, significantly higher than conventional packed-bed thermal ES systems at 70%.

Pumped Thermal ES (PTES) was introduced in the late 1970s (Benato and Stoppato, 2018; Benato, 2017). PTES comprises a reversible heat pump/heat engine and two thermal energy storage vessels, one high temperature and one low temperature. Smallbone et al. (2017) trialed a pilot-scale PTES system. They determined that the techno-economic analysis for PTES should be conducted. With a liquid thermocline and packed bed as the cold store, Davenne et al. (2017) examined the exergy losses of an integrated wind and PTES system known as "Wind-TP" (Wind-thermal pumping) (Garvey et al., 2015b). With a computer simulation of the packed bed, they determined that the exergy loss depends on sphere size and thermal store aspect ratio. Sorknaes et al. (Sorknaes, 2018) presented simulation techniques for modeling seasonal PTES systems with energy system models. The techniques can estimate the actual operation on an hourly basis and the annual thermal losses. Benato and Stoppato (2018) provided a technical overview of PTES. They determined that PTES is able to compete with the other large-scale energy storage technologies, including CAES and batteries in term of energy density and specific cost.

Liquid Air ES (LAES) was proposed in the late 1970s (Zhang et al., 2018). To charge an LAES system, the air is liquefied through refrigeration, and the cool liquid is stored in insulated vessels. To discharge, the liquid air is drawn from the tanks and pumped to high pressure and then allowed to boil. As the liquid air boils, the pressure increases further and the high-pressure gas is used to drive a turbo-generator to generate electricity (Krawczyk et al., 2018). Zhang et al. (2018) conducted energy and exergy analyses for an LAES system based on liquefied natural gas, and concluded

that the electricity storage efficiency of a LAES system could be 70%. Generally, LAES is a promising technology with good potential for taking advantage of waste heat from industrial processes (Antonelli et al., 2017). Xie et al. (2018) studied the economic feasibility of a 200 MW LAES system in the UK and determined that the best system performance, the payback period can be six years.

3.3. Hybrid ES and generation

Hybrid ES is an emerging paradigm for two or more different ES technologies that are integrated into one system. The purpose is to exploit the advantages and overcome the drawbacks of multiple complementary storage technologies.

An example of a hybrid ES system involves CAES and LAES. An LAES system can be connected to a CAES system, where only the CAES is connected to the grid, exploiting CAES's relatively high efficiency and LAES's relatively low cost per unit of storage capacity (Kantharaj et al., 2015a). References (Pimm et al., 2015) and (Kantharaj et al., 2015b) discuss the optimal operation and thermodynamics of such series-connected CAES/LAES systems.

Pimm and Garvey (2014) presented a system that couples FES with CAES. An electricity trading algorithm maximizes the system's revenue through electricity price arbitrage, with the FES responding to the higher-frequency price signals. This configuration could be more profitable than a non-hybrid energy storage plant, that is, using FES or CAES alone.

Hybrid solar and wind generators working with CAES systems were proposed by Ji et al. (2017) to generate stabilized electrical power and hot water. The stored solar thermal energy reheats the compressed air to increase generation capacity before the air enters the air turbine. Round-trip efficiency, exergy efficiency, and electricity storage efficiency can be up to 61.2%, 65.4%, and 87.7%, respectively. Using CSP to preheat the air in a CAES system before compression increases the total exergy for CAES (Cárdenas et al., 2017).

3.4. GIES

Garvey et al. (2015a) provided a detailed account of GIES. GIES systems exist for biomass generation, natural hydropower, and CSP. CSP using power towers or power dish systems coupled with thermal storage is a well-known type of GIES system. Inexpensive thermal storage materials and increased solar receiver efficiencies at higher temperatures are the key research areas to make such

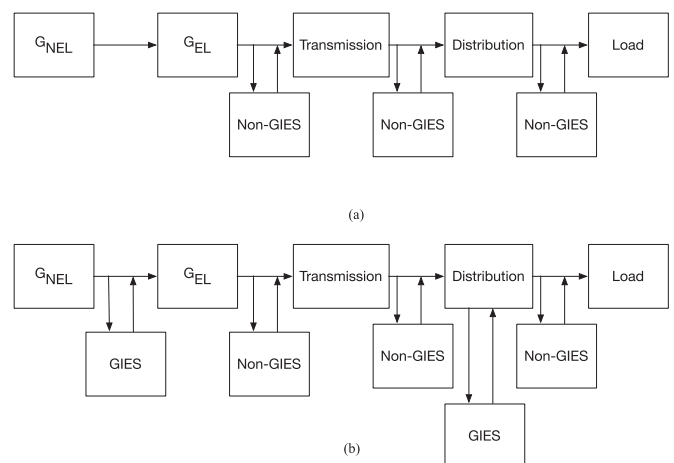

Fig. 2. An electrical power system consisting of a) Non-GIES only; b) GIES and non-GIES.

systems cost-competitive. Molten salts and thermic oils are the most mature heat transfer fluids. Thermal storage can be classed into three categories, namely Latent Thermal Storage (LTS), Thermochemical Thermal Storage (TTS), and STS (Dutta, 2017). Compared to LTS and STS, TTS has a lower charging temperature, heat loss, and volume requirement (Aydin et al., 2015; Bayon et al., 2018). TTS is an emerging type of storage with up to 10 times the ES density over STS. A techno-economic analysis by (Bayon et al., 2018) found that the auxiliary equipment energy consumption and feedstock (e.g., solid reagent) costs are the critical factors for a system's capital cost.

Novel GIES systems have been proposed for wind power. Garvey et al. (2015b) scrutinized wind transmission system designs using exergy analysis and determined that there are challenges with integrating ES into wind power transmission systems, in particular on acceptable performance at different frequencies and compatibility with the electrical grid at minimum cost. Krupke et al. (2017) developed a new type of GIES which consisted of a wind turbine and CAES.

Fig. 2 illustrates how GIES and non-GIES systems can influence the electrical power system. G_{NEL} denotes non-electrical conversion of energy, such as the conversion from photon energy to thermal energy in a CSP plant, and G_{EL} denotes electrical generation.

For a non-GIES-only electrical power system as depicted in Fig. 2a, all the primary energy has to go through electricity conversion at least once for storage (Liu and Du, 2016).

On the generation side, large-scale ES systems (energy capacity ≥ 100 MWh and power capacity ≥ 1 MW) have already been installed and are known as bulk ES. They have large ES capacities and low capital costs per unit of storage capacity. These are PSH, CAES, and LAES (Luo et al., 2015).

ES systems from kW to 10 MW are installed in the distribution and transmission systems to enhance system performance (Zakeri and Syri, 2015). It is useful to store surplus renewable generation for later use and to reduce renewable curtailment. For transmission planning with electrochemical energy storage, Aguado et al. (2017) examined the long-term transmission expansion for a 6-bus test system and determined that the ES system allows delaying the construction of some lines for several scenarios.

Also, at the distribution level, optimizing energy services including thermal insulation and district heating are challenging due to environmental and cost constraints (Coss et al., 2017). Biomass is a renewable energy source and an excellent heat source if used in a carbon neutral way, that is, if all direct and indirect carbon emissions are later sequestered by new plants or trees (It should be noted that the rate at which carbon can be recaptured, and hence biomass's ability to meaningfully contribute towards the Paris agreement targets of limiting the increase in global average temperature, is still a matter of debate (MacDonald and Moore, 2020)). Coss et al. (2017) developed a multi-layer energy service system model and examined the substitution of a decentralized gas-boiler system with a central biomass-fired system. Coss et al. (2017) proposed the "Method relation analysis" to study various evaluation methods for the energy system design and is useful for carbon footprint and energy analyses. The purpose is to examine the dependency of various valuation principles and provide awareness on how policy goals affect sustainable system configuration. Energy analysis is critical to acknowledge the environmental burden of processes and is associated with energy carriers, including all indirect flows of resources and information flows.

Fig. 2b shows the electrical power system with a combination of GIES and non-GIES. Here, the key difference between the GIES and non-GIES-only systems (Fig. 2a) is that, with the GIES, the energy conversion process is minimized by avoiding the conversion to electricity. This "integrates" ES into the generation source. Storage of wind and solar thermal energy can be more efficient with GIES at the generation and distribution levels. Nevertheless, non-GIES is required to provide grid services such as frequency and voltage regulation. The response time for electrochemical storage can be on the millisecond timescale, which is significantly faster than thermal storage. Table 1 summarizes the R&D for non-electrochemical ES systems with low-carbon power generation technologies, which are important technologies for GIES.

GIES can play an important part in maximizing the efficiency of the ES and minimizing system cost. However, R&D in GIES spans from the component level (e.g., CSP and pumped storage heat) to the system level (e.g., on how GIES could benefit the energy system).

In summary, this section has presented a review on emerging ES

Table 1
Current development of non-electrochemical energy storage systems with low-carbon power generation technologies.

		Generation technologies					Solar photovoltaic (PV)	Hydro	Wind
		Thermal cycle			CSP	Solar photovoltaic (PV)			
		Nuke fission	Coal	Gas					
Storage technologies	Pure Heat	C (Abe et al., 1986)	/	/	P (Dutta, 2017; Aydin et al., 2015; Bayon et al., 2018)	/	/	/	
	Sensible	C (Zhao et al., 2018)	C (Garbrecht et al., 2017)	/	P (Dutta, 2017; Aydin et al., 2015; Bayon et al., 2018)	/	/	C (Okazaki et al., 2015; Liu et al., 2017)	
	Fly wheels	/	/	C (Hebner et al., 2002)	/	C (Ye and Sun, 2009)	/	P (Sebastián and Alzola, 2012)	
	CAES	/	/	/	C (Ji et al., 2017; Cárdenas et al., 2017)	/	C (Wang et al., 2013)	C (Ji et al., 2017; Cavallo, 2007)	
	PHS	/	/	/	/	C (Ma et al., 2014, 2015)	W	C (Kapsali et al., 2012; Bueno and Carta, 2006)	
	Pumped storage heat	/	/	/	/	/	/	C (Garvey et al., 2015b; Sorknaes, 2018)	
	Gravity	/	/	/	/	C (StratoSolar)	/	/	
	Liquid air	C (Liet al., 2014)	/	/	/	/	/	/	

/ = Not available.

C (Concept) = Described in the literature.

W (Working) = At least a plant is physically built.

P (Practice) = A common industrial practice.

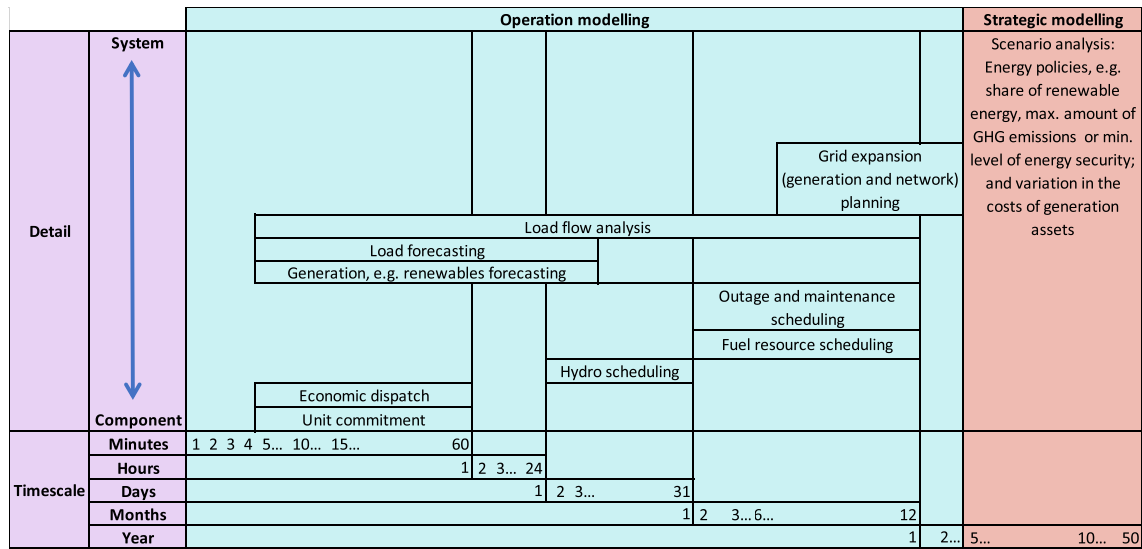

Fig. 3. Time horizon and electrical power system analysis.

systems and energy forms, with emphasis on GIES. The next section reviews the modeling techniques and models for electrical power system planning and operation with emphasis on ES.

4. Electrical power system planning and operation

The goal of LEPSMs is to aid optimal system planning and operation. In the literature, there is no formal definition for short-term, medium-term, or long-term power system analysis (Khuntia et al., 2016). The usual consensus timescale is for short-term to be 5 years or less, medium-term to be from 5 to 15 years, and long-term to be 15 years or more (Hall and Buckley, 2016). Fig. 3 categorizes the study horizons and system study methods.

The two types of system studies are given as follows:

Planning: The goal of capacity expansion planning is to ensure that the system will continue to meet energy demands by upgrading the system (Park and Baldick, 2016). The temporal resolution can be monthly or annually. Direct Current (DC) load flow analysis can be included with linear resistive transmission line constraints. Capacity Expansion Models (CEMs) are often used for electrical power system planning (Diakov et al., 2015; Shirley and Kammen, 2015; Blair et al., 2015). The goal is to identify the most cost-effective long-term investment in and retirement of transmission and generators to meet the power system reliability requirements. Due to computational power limitations, CEMs do not consider the short-term operation of the system, where the dispatch details are neglected. Diakov et al. (2015) proposed a “Linking Tool” to bridge Production Cost Models (PCMs) with CEMs.

Operation: The goal of system operation planning is to ensure the system is operated to achieve a power balance between generation and load, and to determine the optimal dispatch. This concerns unit commitment, Alternating Current (AC) load flow analysis, and economic dispatch. The temporal resolution can be from minutes to hours, where short-term power system phenomena, such as voltage, real power, and reactive power, are considered.

Table 2 presents descriptions of the three main types of models in power sector analysis. On the consumption side, short-term load forecasting has been used for short-term system operation. In long-term electrical power system planning, the change of technologies and energy policies have an impact on consumption behavior (Guo et al., 2018). McPherson and Tahseen (2018) acknowledged that the

PCM “filters” the result and affects the electrical power system design, market regulation, and modeling. For ES, profitability is affected by the dispatch horizon and bidding mechanism. Further research is required to investigate the benefits that ES brings to system operators, utilities, and energy consumers (Zidar et al., 2016). Table 3 presents the scope of reliability assessment in the three types of modeling. It is evident that long-term system planning (i.e., capacity expansion) typically excludes most aspects of reliability and poses a serious issue.

4.1. Long-term electrical power system models

Future energy scenarios are built to evaluate the impacts of policy decisions, climate change, and energy security policies (DeCarolis et al., 2017). There are several LEPSMs (Gargiulo and Gallachóir, 2013; Mahmud and Town, 2016).

Top-down models are based on macroeconomics (Klinge Jacobsen, 1998) and are not the scope of this paper, where technology is the focus. Bottom-up models are based on a detailed description of the technical components of the energy system (Pfenninger et al., 2014; Mischke and Karlsson, 2014; Yi et al., 2016). These are systems engineering optimization models used for medium-to long-term energy system planning, analyzing climate change policies, and developing scenarios.

Moser (Moser et al., 2020) studied how the future European electricity system would be affected by techno-economic parameters of electrical ES systems with the cost-optimizing energy system model Renewable Energy Mix (REMIX). The first study was a cost sensitivity analysis with common ES technologies. The deployment of photovoltaic (PV) and wind systems can impact on the ES installation capacity and cost effectiveness. The second study was concerned with the competition between mature and novel ES technologies. For different regions including Southern Europe, pumped hydro ES is the cost optimal solution. However, Central Europe relies on a combination of pumped hydro ES, hydrogen ES, batteries, and power-to-heat ES to be cost optimal. The dominant bottom-up models are MARKAL, TIMES, and MESSAGE (Model for Energy Supply Strategy Alternatives and their General Environmental Impact). TIMES is the successor to MARKAL, and it adds the options to include unequal length periods and to define commodity flows as new variables with EFOM. MARKAL/TIMES is possibly the

Table 2
Electrical power system modeling methods.

Model	Purpose of use	Software packages	Questions to be explored	Typical model output
Capacity expansion	<ul style="list-style-type: none"> Studying the effects of power sector policies and technology changes on the energy mix in the long-term 	<p>National-scale</p> <ul style="list-style-type: none"> National Energy Modeling System (NEMS) - U.S. Energy Information Agency Long-range Energy Alternatives Planning System (LEAP) - Stockholm Environment Institute The Integrated MARKAL-EFOM System (TIMES) - International Energy Agency (IEA) OSeMOSYS Renewable Energy Mix (REMix) Regional Energy Deployment System (ReEDS) - National Renewable Energy Laboratory (NREL) Haiku - Resources for the Future MARKetAllocation (MARKAL) - International Energy Agency (IEA) <p>Utility-scale</p> <ul style="list-style-type: none"> Resource Planning Model (RPM) - NREL Aurora - Electrification Products Industrial Solutions (EPIS) System Optimizer - ABB PLEXOS - Energy Exemplar 	<ul style="list-style-type: none"> What is the optimal energy mix to meet the long-term energy demand? What are the cost implications of environmental policies on various energy mixes and capacity? What is the cost of different energy mixes to achieve a minimum greenhouse gas emissions goal? How will the uncertainty in future natural gas prices affect capacity investment? What will the change be in energy consumption and expenditure? What are the energy distribution and efficiency effects of different energy policies? 	<ul style="list-style-type: none"> Annual and system lifetime energy generation Generation and transmission capacity changes System lifetime and annual greenhouse gas emissions Annual fuel consumption Net present value and electricity prices
Production cost	<ul style="list-style-type: none"> Short-term studies compared to CEM, but at higher temporal resolution (hours to 5-min) Analyzing the impact of changes in the system generation on system operation Considering regional prices and conducting transmission congestion studies Determining emissions at a high resolution 	<ul style="list-style-type: none"> PROMOD - ABB GE-MAPS - General Electric PLEXOS - Energy Exemplar GridView - ABB PowerFactory - DiGSILENT MATPOWER - Cornell University 	<ul style="list-style-type: none"> What is the least cost dispatch of a complex system of interconnected generators to reliably meet load in every hour of the day at every location? What are the impacts on operations, emissions, and resource adequacy, of the retirement of coal or nuclear units in a given region? What is the maximum potential for switching from coal steam units to natural gas combined cycles? 	<ul style="list-style-type: none"> Minutes and hourly power flow Regional prices Short-term emissions Fuel consumption Loss of load Ancillary service prices Renewable curtailments

Table 3
Electrical power system models and reliability assessments considered.

	Aspects of reliability assessments considered						
	Generator (Resource) adequacy	Flexibility requirement	Transmission adequacy	Generator contingencies	Transmission contingencies	Frequency stability	Voltage stability and control
Capacity expansion models	Limited: Possible peak capacity constraint for resource adequacy	Limited: Most models are not simulated at the high temporal resolution, e.g., hourly	No	No	No	No	No
Production cost models	Yes	Yes	Limited: DC optimal power flow for transmission adequacy	Limited: Generation reserves in each time period are obtained. These reserves can be adequate to meet contingency events, but not the actual consequences of contingencies	Limited: Operation of reserves cannot be simulated to check frequency stability	No	No

most widely used general-purpose energy systems model (Pfenninger et al., 2014; Kannan and Turton, 2013; Pietrapertosa et al., 2010; García-Gusano et al., 2016). By examining these models, we believe that examining the temporal and spatial scales are becoming increasingly important, to accurately answer questions about the technological and economic feasibility of evolving energy systems (Laes and Couder, 2014). Spatial detail may be critically important for renewables: their economic potential and generation costs depend greatly on their location (Pfenninger

et al., 2014), such as for PV systems (Sommerfeldt and Madani, 2017).

Pfenninger et al. (Pfenninger et al., 2018) showed that open-source energy system models and data introduced several benefits. These included enhancing research quality, minimizing work duplication, enhancing modeling legitimacy and credibility, providing policy debate transparency, and importantly, giving government agencies and researchers access to high-quality planning tools and data without financial obligations.

4.2. Capacity expansion and production cost integrated LEPSMs

Researchers have realized the importance of integrating capacity expansion models and production cost models to improve long-term energy studies from the power grid's perspective. The power grids for each country have distinctive features (Boston and Thomas, 2015). However, traditional energy system modeling, such as that performed using TIMES, is decoupled from power system analysis. Consequently, many phenomena, such as real power balance, reactive power balance, voltage magnitude, and voltage angle, are not considered (Rose et al., 2016).

Pfenninger et al. (2014) described energy system modeling considering uncertainty and a range of spatial and temporal resolution scales. They noted that at the local scale, individual households and businesses consume energy to meet the demand for services and products. At the national scale, organizations and communities influence and guide the adoption of technologies and policies.

Current energy studies have employed assumptions for renewable generation, such as Capacity Factor (CF) or annual average energy production (Pietrapertosa et al., 2010; Pratama et al., 2017; Aslani and Wong, 2014; Parrado et al., 2016; Chadee and Clarke, 2017; Korsavi et al., 2018). By observing the aggregate yearly energy production, Korsavi et al. (2018) determined the economic and energy performance of 14 rooftop PV systems rated at 5 kW in Iran, and showed that there is a considerable variation in economic performance when subsidies are included for the system, where the payback period can be reduced by up to four times (i.e., from 48 years to 12 years) when there are subsidies. The net present value will be negative for all cases without any subsidy.

CF and annual average values are debatable, and the uncertainty for renewable generation is generally not taken into account (Shirley and Kammen, 2015; Min et al., 2018). These models used for policy-making tend to have high technology details but a lack of spatial details (Simoes et al., 2017). Recent works have considered including CEMs with production cost models (Rose et al., 2016; Min et al., 2018; Zhang et al., 2016; Seljom and Tomasgard, 2015; Scholz et al., 2017; Zhang et al., 2013; Poncelet et al., 2016; Lunzet et al., 2016).

High-resolution data, particularly for uncertain renewable sources, are of significant importance (Scholz et al., 2017). Due to the inter-year and seasonal changes in renewable generation, long time series are necessary for energy system modeling with the presence of wind and solar power.

Due to the rapid evolution of the ES system, the present modeling technique in TIMES is inadequate. Capturing the characteristics of each energy storage medium is essential. So far, no storage solution has been properly addressed in the current long-term energy system models. ES can increase the utilization of renewable energy by storing surplus energy for use at a later time when a more expensive or more polluting generation would otherwise be used (Lai et al., 2017). The surrounding incentives and business models that will allow batteries to capture this value still need to be clarified (Braff et al., 2016).

The two key challenges in integrating the capacity expansion and production cost models are the following:

Accommodating emerging technologies (including renewables, Electric Vehicles (EVs), and ES systems): Integrated models present challenges in including various key energy technologies. Heylen et al. (2016) presented a framework to study and compare the socio-economics and reliability of power systems, with a focus on the short-term decision-making processes of transmission system operators. Key technologies, including renewables and ES, were found to be missing. Similarly, Deane et al. (2012) developed a methodology to provide feedback to an energy system model from

the electrical power system unit commitment and dispatch. The power and energy system modeling was conducted with PLEXOS and TIMES. The only ES technology considered was pumped hydro. They determined that energy systems model could undervalue flexible resources, undervalue wind curtailment and overvalue the use of baseload plant.

Results *quality and model complexity:* Electricity network and generator characteristics are not included in current long-term energy system modeling. One reason for this is that power flow studies can be a computational burden in long-term energy system modeling (Poncelet et al., 2016). Li et al. (2016a) presented a method to simplify the modeling of power flows in the inter-regional transmission grid using market-based power flows. In it, the power flows are subject to the net transfer capacity between regions rather than the physical capacity constraints of specific transmission lines. Barrows et al. (2015) presented the Resource Planning Model which co-optimizes dispatch and capacity expansion. The dispatch period was based on a simplified chronological and high-resolution infrastructure, load, and resource data. The model simplification affected the computational complexity of the CEMs. The trade-off between result quality and model complexity is a subject of ongoing research. Zhang et al. (2016) proposed a bi-level integrated generation-transmission expansion planning model. The work highlighted that complexity increases at a significant rate when including more elements in the system, and high-performance computers were required to model large-scale power systems. Chronological electricity demand profiles enable the model to capture changes in services such as the electrification of heating and transport (Zhang et al., 2013). Zhang et al. (2013) developed an integrated planning model that uses electricity load curves from representative days. Similarly, Poncelet et al. (2016) adopted time slices (or time series) for renewable energy sources temporal representation.

Table 4 presents a comparison of the different characteristics of existing LEPSMs by covering geographic scale, time resolution, economic analysis techniques, and ES systems. There is a need for a novel LEPSM that studies multiple timeframes to facilitate a geographic scale-up to the national level. ES models are limited within the present LEPSMs, and more types and technical details of storage are necessary. This is a particular concern for the assessment of GIES and non-GIES alternatives to meet the low-carbon economy. Models with high temporal resolution (e.g., seconds) will potentially give better Results and highlight the capability of certain technologies (such as electrochemical energy storage); however, computational complexity becomes a major challenge.

The key findings from this section are these:

- Recent literature has focused on the temporal resolution of data on generation from renewables and energy consumption.
- National energy studies can be enhanced based on multi-region systems as opposed to a national system.
- Due to ES (including GIES and non-GIES), such as mechanical, thermal, and electrochemical, having different technical properties and costs, similar to the concept of the optimal generation mix (e.g., wind and solar), the optimal energy storage mix for a region (e.g., PSH and FES) is a relevant research area.
- Exergy analysis for ES and electricity generation will have a profound effect in determining the optimal energy scenarios based on optimal energy conversion and energy loss minimization "from the source."

Progress has been made to improve long-term electrical power system studies, and hybrid models consisting of CEM and PCM have been introduced. However, due to generation and demand uncertainty, data processing and treatment are important factors for

Table 4
Geographic scale, timeframe, cost analysis, and ES for LEPSMs.

LEPSM	Scale		Timeframe				Cost analysis		ES type	Ref.
	National	Regional	Seconds	Minutes	Hour	Year	Net present value	LCOE		
National Energy Modeling System (NEMS)	✓	✓				✓	✓		PSH	The National Energy Mode (2009)
Long-range Energy Alternatives Planning System (LEAP)	✓	✓				✓	✓	✓	None	Long-range Energy Altern (2010)
The Integrated MARKAL-EFOM System (TIMES)	✓	✓				✓	✓	✓	Known as 'storage process' for all commodities such as energy and natural resources	Loulou et al. (2016)
MARKetAllocation (MARKAL)	✓	✓				✓	✓		Generic	A comparison of the "Open Source Energy Model)
OSeMOSYS	✓	✓				✓	✓			Fichter (2016)
Renewable Energy Mix (REMix)	✓	✓			✓	✓	✓		Thermal	
Regional Energy Deployment System (ReEDS)	✓	✓				✓	✓		PSH, electrochemical batteries, CAES, and thermal	Shortet al. (2011)
Haiku	✓	✓				✓	✓	✓	PSH	Paul and Burtraw (2002)
Resource Planning Model (RPM)	✓	✓			✓	✓	✓		PSH	Mai et al. (2013)
Aurora System Optimizer	✓	✓				✓	✓		Battery	v13.1," [Online] System Optimizer (2015)
GE Multi Area Production Simulation (MAPS)	✓	✓			✓				PSH	PJM Renewable Integration (2014)
PROMOD		✓				✓			CAES	technical over (2015)
GridView		✓				✓			PSH	GridView: Simulate secur (2016)
PowerFactory DiGSILENT		✓		✓	✓		✓		Battery	PowerFactory application
MATPOWER		✓		✓	✓				Mathematical constraints such as state-of-charge	ZimmermanCarlos and Murillo-Sanchez (2016)
PLEXOS	✓	✓		✓	✓	✓	✓		Thermal, electrochemical, and mechanical	by Energy Exempla (2017)
Proposed framework (LEPSF)	✓	✓	?	✓	✓	✓	✓	✓	Thermal, electrochemical, mechanical, GIES and, non-GIES	

energy system modeling. At present, there is no long-term electrical power system model that performs the future electrical power system planning which adequately considers ES (in particular, GIES and non-GIES). The next section describes the key aspects that LEPSMs need to incorporate to perform electrical power system long-term planning including ES.

5. Three modeling aspects for LEPSM improvement

The stochastic fluctuations created from power generation and consumption need to be captured in the modeling process. Section 4 shows that present models cannot deal with the fluctuations of power generation and consumption. As discussed in Section 3, ES addresses electrical power system negative phenomena (e.g., power imbalance and frequency deviation) that typically occur in a short period (e.g., minutes and hours). To address system uncertainties, this section introduces three aspects that can potentially improve energy system modeling: renewable scenario reduction, ABM of energy consumption, and leveled cost of electricity for intermittent renewables and ES.

5.1. Renewable generation scenarios

On the generation side, machine learning and data analytics have been applied extensively in the areas of renewable energy forecasting. Both artificial intelligence and physical approaches have been employed for short-term (i.e., 15 min) interval renewable resource predictions (Lai et al., 2017a). For long-term electrical power system planning, an effective approach is to capture and classify the underlying changes in renewable resources. Capturing

the fluctuations in a reduced dataset can increase computational efficiency and reduce data processing requirements. This section presents existing scenario reduction methods for the prominent intermittent renewables, that is, solar and wind.

Wind: Ma et al. (2013) proposed a scenario generation and reduction method for forecast error distribution and fluctuation distribution in wind power. A multivariate normal distribution with inverse transform sampling was used to generate a large number of scenarios. Lee and Baldick (2017) depicted a correlated scenarios approach for load and wind power with a generalized dynamic factor model which had many advantages, such as the ability to generate a desired number of scenarios, and which was confirmed to have similar statistical characteristics to the actual measurements. To optimize the distances between the original and synthetic scenarios at the same time, Li et al. (2016b) proposed the use of a heuristic search method for wind power time series.

Regarding speed and quality, the heuristic search method can outperform the well-adopted backward/forward reduction method (Growe-Kuska et al., 2003) based on a scenario tree construction algorithm. It continuously reduces the number of scenarios by changing the tree structure and grouping similar scenarios. Xu et al. (2018) examined the placement of stochastic optimal thyristor-controlled series capacitors in power systems featuring high wind power penetration, and the backward scenario reduction method was used. Fig. 4 presents the wind scenario reduction for three years (2013–2015) of normalized North Carolina, USA (longitude –81.65°, latitude 36.35°, and 1316 m above sea level) wind data with a sampling interval of 1 h (NREL Wind Prospector). Fig. 4a shows the original wind data, where each color represents a day. Only 30 days were randomly selected for the display due to the

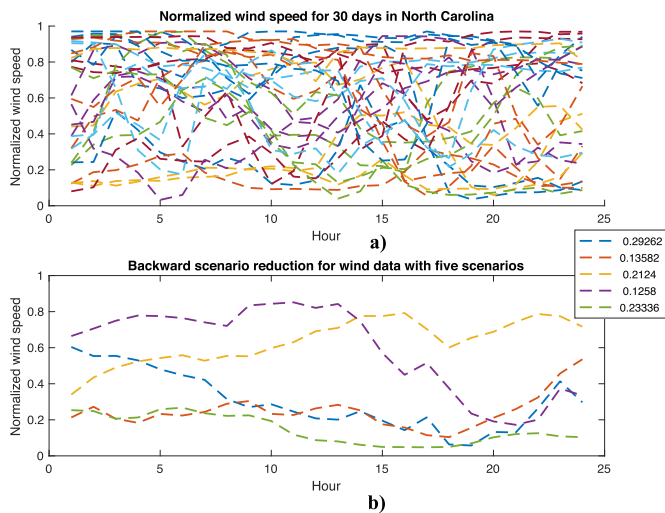

Fig. 4. a) The normalized wind speed for 30 days in North Carolina, USA; b) the five reduced scenarios, data from (NREL Wind Prospector).

restricted space. As shown, the wind speed was highly random for each day, and the scenarios obtained showed different trends of the daily wind speed variation. Fig. 4b shows the five typical wind scenarios obtained with backward scenario reduction. The corresponding probability for each scenario is provided in the legend. The purple line shows that the wind speed was generally high in the morning and was significantly reduced after 15:00. The green line gives the scenario for a poor wind day, accounting for nearly 24% of the days in the four years.

Solar: Lin et al. (2017) examined the use of scenario generation and reduction methods based on k-means clustering for power flow analysis in transmission expansion planning. The distance metric is an important aspect of the clustering algorithm. Hence, Lai

et al. (2017b) proposed the use of Fuzzy C-means and Dynamic Time Warping distance for a solar clearness index time series. Fig. 5 depicts six scenarios determined for four years (2011–2014) of clearness index data for Kenya in winter with Fuzzy C-means and Dynamic Time Warping. The location for the solar irradiance was Gitaru Dam, Kenya with longitude 37.73°, latitude -0.79°, and elevation at 969 m above sea level. The solar irradiance data were obtained from Solargis (Solargis). The sampling interval was one sample per 15 min. The centroid of each cluster is depicted using a black line, with the red and blue lines showing minus one and plus one standard deviation, respectively. The actual clearness index data are represented using crosses, with the same color used for the same day. Cluster 5 represents a “clear day,” where there is little fluctuation of the solar resource. The highest amount of solar resource curtailment was in cluster 6. Cluster 4 shows that the clearness index was low before 10 a.m., and then increased later in the day; cluster 1 shows the inverse, a clear morning followed by a less clear afternoon. These clusters showed similarity in the clustered clearness index. In addition to determining the similar days, the percentage of appearances was easily determined by calculating the ratio between the number of days in the cluster to the total number of days of the dataset. This is useful in informing the planner as to how often a certain scenario occurs. This work determines a dynamic distance metric gives better performance than a static distance metric for solar resources and that the computational complexity surrounding dynamic time warping is extremely high. As a clustering prerequisite, future work will need to look into methods for solar irradiance time series data granulation that generates high-quality representative irradiance.

5.2. ABM of energy consumer behavior

On the demand side, human behavior influences energy consumption and is assumed to be homogenous and hyper-rational (Gerstet al., 2013). Models such as TIMES employ a small number

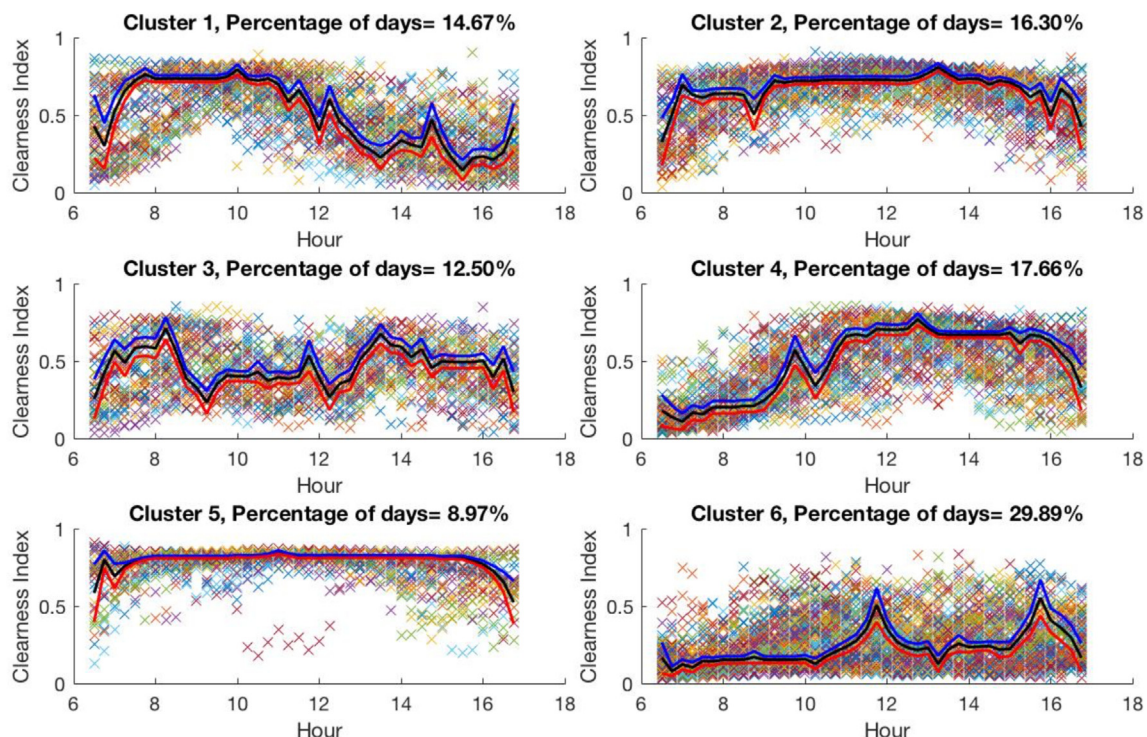

Fig. 5. Scenario reduction for solar clearness index in Kenya during winter with Fuzzy C-means and Dynamic Time Warping (Lai, 2017).

of typical energy consumption curves for energy studies (de Boer and van Vuuren, 2017). Future energy demand will depend on technological development, for example, EVs, data centers, and smart buildings and appliances (Zipperer et al., 2013; "Future energy scenarios", 2016). ABM can address the above issues, and it consists of complex systems, game theory, computational sociology, and the simulation of multiple actors. The current literature for energy studies with ABM is as follows:

Transmission and distribution level: Ma and Nakamori (2009) compared optimization models with ABM for energy system studies. ABM is a better option than an optimization model in determining possible future scenarios and mitigating unexpected problems. Gonzalez de Durana et al. (de Durana et al., 2014) presented a generic approach to modeling multi-carrier energy systems (e.g., heat and gas) with ABM. However, future work needs to study energy efficiency, energy conversion, and ES. Andoni et al. (2017) conducted a comparative study on how game theory can assist network operators in determining optimal generation curtailment rules and transmission charges for electricity networks. A model was developed which captured the stochastic nature of renewables and demand variations and identified the game equilibrium that gives optimum installed generation capacities.

Residential level: Rai and Henry (2016) provided a summary of ABM of consumer energy choices and identified the applied and scientific aspects of energy demand to improve policy design. They determined that an energy demand model may be designed and calibrated with data on electricity demand, temperature, and weather. Guo et al. (2018) have promoted household energy conservation for global sustainable development. A review was provided on residential electricity consumption behavior. This consisted of social psychology (gender (Yang et al., 2015) and employment (Chen, 2017)) and interventions (energy consumption goals and reward) to encourage households to minimize electricity usage.

EV adoption: The growing use of EVs in power systems is creating challenges, such as congestion in distribution networks, related to power transformer limits and bus voltage violations (Hu et al., 2016). ABM is effective for incorporating uncertainties surrounding the behavior of real EV drivers, such as the energy consumed on journeys and during charging events (Olivella-Rosell et al., 2015). As EVs use ES, long-term energy system models require the inclusion of EV usage. Adepetu et al. (2016) presented an ecological modeling approach to study how various governmental policies and ES technologies affect EV adoption and charging activities. Yang et al. (2018) presented an integrated dynamic method with ABM to examine the adoption of EVs and the evolution of EV charging demand over 20 years. This was based on the relationship between the number of EVs and their charging demand.

For ABM, Big Data Analytics (BDA) and cloud computing technology for behavior pattern mining will assist in developing intervention strategies and effective energy consumption reduction. BDA is concerned with exploring value in data to support decision-making under high volume, high variety, and high-velocity data environments (Akhavan-Hejazi and Mohsenian-Rad, 2018; Alahakoon and Yu, 2016).

BDA can provide an in-depth understanding of the complicated effects of intermittency and uncertainties on the power system (Kang et al., 2018). In contrast to the traditional model-based approach for power system operation and planning, BDA introduces data-driven optimization models (Akhavan-Hejazi and Mohsenian-Rad, 2018; Kang et al., 2018). BDA consists of "data mining and machine learning" (regression, classification, and clustering), "predictive analytics" (off-domain and domain data forecasting), "statistical analysis," "artificial intelligence" (pattern recognition, cognitive simulation, perception, and expert systems),

"data visualization" and "natural language processing" (Akhavan-Hejazi and Mohsenian-Rad, 2018; Kang et al., 2018; Chen et al., 2018). References (Sedkaoui, 2018; Ye et al., 2018) provide a comprehensive literature review of BDA.

In power systems, data visualization promotes information exploration and, subsequently, knowledge discovery (Zhu et al., 2011). Traditionally, power system operators have relied on energy management systems to generate visualizations for monitoring, controlling, and optimizing system performance. The nature of data visualization in power systems is complex. This is due to the enormous size of transmission grids and the huge number of components. Traditionally, visualization techniques are often computationally intensive, requiring the system operator to select the most relevant features. This largely restricts the operators in exploring options and making effective decisions. Zhu et al. (2011) proposed a data-driven approach for interactive visualization of power systems, built upon the Common Information Model.

In addition to the renewables scenario reduction techniques introduced in Section 5.1, as discussed by Akhavan-Hejazi and Mohsenian-Rad (2018), the features of BDA that benefit the LEPSM are the following:

- Integrating databases with statistical packages: Many databases have restricted statistical functionality. Standard practice is to extract a portion of data from the database to conduct statistical analysis. However, this causes a loss of detail due to down-sampling from the database. An enhanced approach is to integrate statistical computation with parallel databases.
- Parallel computing: To speed up the computational process, methodologies are created to distribute the intelligence and decision-making process across many central processing units. This approach can assist in estimating unmonitored load and PV generation profiles (Sossan et al., 2018).
- High scalability: The curse of dimensionality will challenge various traditional analytic techniques. As such, these mature techniques need to be revised and adopt other algorithms that can scale-up with huge dimensions. For nonlinear alternating current optimal power flow problems, high scalability can be achieved by decomposing power flow data into low variation components and low rank, and by exploiting the sparsity of the system matrices.

In summary, BDA for ABM is a promising research area. However, there is a need to consider EV modeling alongside the intermittency of generation, particularly in a long-term transition to an energy system featuring a high penetration of renewable energy.

5.3. LCOE for intermittent renewables and ES

Considering modeling output and economic metrics, this section argues that metrics need to be reconsidered for non-dispatchable energy sources.

The LCOE for energy studies contains many relevant factors and assumptions such as CF, capital costs, and operational costs (Lai and McCulloch, 2017; Darling et al., 2011; Obi et al., 2017). Typical LCOE assessments overvalue solar PV generators because, as discussed by Lai et al. (Lai et al., 2017), one of the critical assumptions made for solar PV is the CF. The CF for renewables is highly affected by the intermittent energy source. Obi et al. (2017) presented a novel LCOE calculation method for different types of utility-scale energy storage. The LCOE and marginal LCOE for a redox flow battery and a Lithium-ion battery alongside a PV system were studied by Lai and McCulloch (2017). Since ES is not an electrical generator, leveled cost of delivery was also proposed to consider the cost of a storage system's "electricity generation."

Many LCOE studies have excluded relevant factors (e.g., intermittence of renewable energy, wholesale market price, and incentives for electricity), thus hindering the credibility of LCOE (Rose et al., 2016; Simoes et al., 2017; Joskow, 2011). Hence, the system operation needs to be considered when computing the LCOE. LCOE may be useful when used along with electrical power system modeling.

Fig. 6 depicts comparisons between electricity demand and the electricity produced to meet this demand using dispatchable generators and intermittent solar PV. The wavy black area denotes the energy generated that is fully consumed by the demand. In Fig. 6b, the surplus electricity (area denoted with black circles) is produced but not used to meet the demand.

We considered the concept of LCOE with Fig. 6 and provided a modification to be more suitable for renewables and ES. The widely used LCOE equation is given in Equation (1) (Lai and McCulloch, 2017; Darling et al., 2011) as follows:

$$LCOE = \frac{\sum_{n=0}^N \frac{\text{Capital cost}_n + \text{Operation cost}_n}{(1+d)^n}}{\sum_{n=0}^N \frac{CF_n * 8760 * \text{Rated power}}{(1+d)^n}}, \quad (1)$$

where d is the discount rate (%), and n is the year, $n = \{1, 2, \dots, N\}$. Since energy is the integral of power with respect to time, Equation (1) can be revised as Equation (2) below:

$$LCOE = \frac{\sum_{n=0}^N \frac{\text{Capital cost}_n + \text{Operation cost}_n}{(1+d)^n}}{\sum_{n=0}^N \sum_{t=1}^{8760} \frac{P_{\text{Effective}_{t,n}}}{(1+d)^n}}, \quad (2)$$

where t is the hour throughout the year. The equation shows how power can be used to compute the LCOE. When CF is used, it is assumed that the electricity produced is reflected in the LCOE; for example, LCOE will decrease as more electricity is produced, as shown in Equation (1). A question arises however over whether it is valid to include this surplus electricity into the calculation of LCOE. It is important here to revisit the concept of LCOE: it is defined as the lifetime average cost of electricity in \$/kWh required for the

system to break even (Lai and McCulloch, 2017). The surplus energy, unless it is stored with ES or exported to external electrical power systems for consumption, will not be consumed or generate any profit, and will affect the lifetime break-even cost. Specifically, the issue with the LCOE metric is that it does not consider the energy that is not utilized (i.e., surplus). A more suitable LCOE measure for renewables is defined in Equation (3), and this metric will be examined with a solar case study in Section 6.3:

$$LCOE_{\text{proposed}} = \frac{\text{Lifetime cost}}{\text{Lifetime effective electricity production}}, \quad (3)$$

In summary, this section presents a review of theories in three areas that may enhance the energy system modeling, namely generation, demand, and economics.

6. A novel framework for long-term electrical power system modeling

This section presents the proposed framework in detail, with a focus on the three areas discussed in Section 5. The long-term power flow electrical power system framework (LEPSF) aims to enhance the consideration of generation and consumption uncertainty, and give a more accurate assessment of LCOE. It includes power losses and reliability evaluation. A co-simulation model for generation and demand predicts energy consumption based on the cost of electricity, and power flows are optimized based on the co-simulation model. Fig. 7 presents the novel LEPSM integrating power flow analysis for electrical power system operation. This model consists of two stages. Stage 1 develops a co-simulation model for the power generation and consumption with power flow analysis. Stage 2 optimizes the electrical power system using optimal power flow and performs scenario analysis. Stages 1 and 2 are short-term and long-term studies, respectively, as discussed in Section 4.

Scenario reduction for intermittent renewables is an input. The scenarios are used in a power flow analysis. Optimal power flow is adopted for the power system optimization. Scenario studies are conducted with real power and reactive power for the long-term electrical power system modeling. Power balance at each time

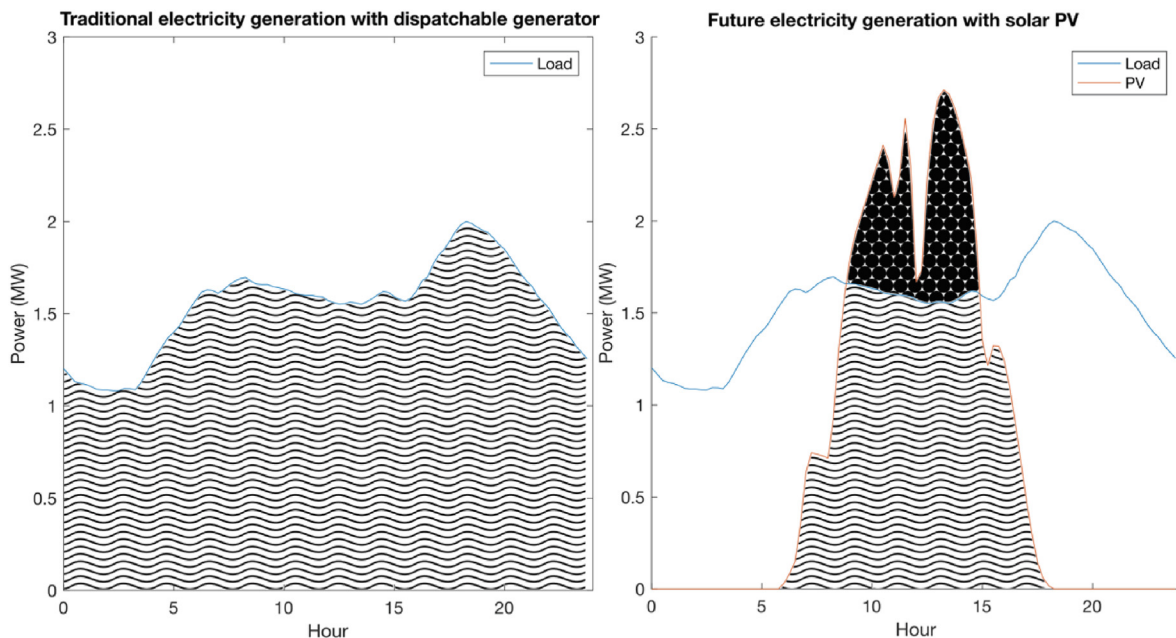

Fig. 6. a) Load met with dispatchable generators in a traditional electrical power system; b) Load met with PV plant in a future system.

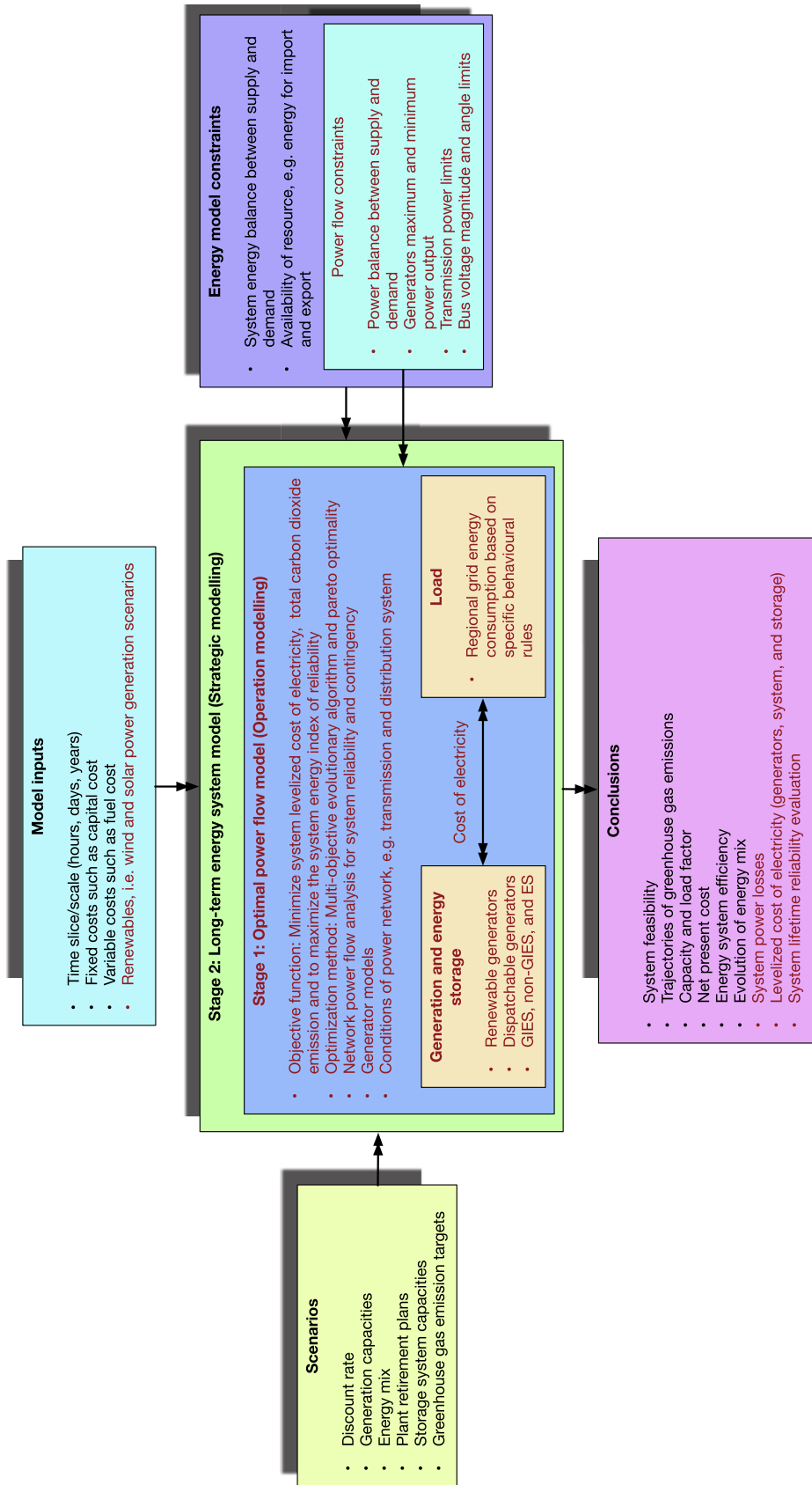

Fig. 7. The proposed LEPSF.

interval (e.g., hour) is achieved to maintain the annual energy balance. However, multi-objectives present a new optimization problem: maximizing reliability and minimizing LCOE and lifetime carbon emissions for the system. In the framework, the black text denotes the factors adopted in a traditional long-term electrical power system model with the red text denoting the factors to be included in LEPSF. Traditional factors such as CFs and average energy output are removed in the LEPSF and replaced by generator models and renewable generation scenarios.

Based on the optimal solutions, fuzzy decision-making and Pareto optimality are considered in determining the optimal trade-off for the optimization problem. Since the optimization is highly nonlinear with the objectives, multi-objective optimization techniques, such as particle swarm optimization and genetic algorithms, are used to solve the power flow optimization problem (Lai, 1998).

6.1. Agent-based and power flow model integration

Power flow analysis has been used in reliability and economic analysis of power systems. Traditionally, a few extreme cases, such as light load and heavy load, are used to determine the system safety and feasibility (Lai and Ma, 1997; Ma and Lai, 1996).

In this framework, generators, loads, and ES act as agents in the power flow model. Based on the specific behavioral rules (Section 5.2), the demand on the load bus in the power flow study is determined based on power generation from the dispatchable source, non-dispatchable source, and ES. Since the cost of electricity generation will influence the electricity selling price, the energy consumption will vary accordingly. The co-simulation model consists of the energy consumers responding to the cost of electricity. Generators and ES will dispatch according to the energy consumers' power requirements.

As an example, a specific behavioral rule for energy consumption in Equation (4), adapted from Rai and Henry (2016), calculates the peak demand at different years (P_{Rated}) for agent i at time t in Equation (5) below:

$$Prob_{i,t} = aE_i + (1 - a)Z_{i,t} \quad (4)$$

$$P_{Actual,t} = Prob_{i,t} * P_{Rated}, \quad (5)$$

where P_{Actual} is the actual energy consumption, the variable $E_i \in (0, 1)$ represents the energy consumption economic factor (e.g., cost of electricity), and $Z_{i,t} \in (0, 1)$ represents the social influence impacts on energy consumption behavior, such as thermal comfort. The model parameter a controls the relative importance of economic and social factors, with both factors being balanced if $a = 0.5$. The energy consumption model is fitted against historical and expected future energy consumption data. ABM calibration and validation are critical research questions in confirming the quality of the proposed model (Guerini and Moneta, 2017). Calibrated models have been validated by applying the ABM to a set of "test data."

6.2. A two-stage scenario and multi-objective optimization framework

This section provides the mathematical description of LEPSF. The three optimization objectives are defined in detail, namely, the system's LCOE, system energy index of reliability, and total carbon dioxide emissions.

There are several objectives in PCMs and CEMs. For both types of model, a common objective is to minimize carbon dioxide

emissions. In PCMs, this includes economic dispatch and minimization of transmission losses, that is, active power losses. In CEMs, a common objective is to minimize the LCOE. Under a fixed scenario (e.g., a given discount rate and energy mix), the proposed objective function for the LEPSM is used as described in Equation (6):

$$\min(w_1.f_1 + w_2.f_2 - w_3.f_3), \quad (6)$$

where f_1 is the system's LCOE (\$/kWh), f_2 is the total carbon dioxide emissions, f_3 is the system energy index of reliability, and w_1 , w_2 , and w_3 are different weighting factors (summing to one). Therefore data normalization may be required for the variables to be comparable.

Fig. 8 shows the one-line diagram for a 3-bus electrical power system with a dispatchable power generator, an ES, an intermittent power generator, and a load. The slack bus compensates for system power losses, and voltage magnitude V and voltage angle θ are known. The real power P (kW) and reactive power Q (kVAr) are specified for the load in a PQ bus and could be applied to non-dispatchable generators and loads (Li et al., 2016c). For the busbar with ES, the modeling needs to consider delivering power via GIES and non-GIES approaches. For example, for wind power, the generator and ES could be based on the widely known approach which employs a permanent magnet synchronous machine wind power generator and a battery (non-GIES) (Xia et al., 2018). The GIES alternative would be a wind compressor and pumped ES (Garvey et al., 2015b). There is a significant difference in both technologies, but the purpose of the generator-storage system is the same: to provide electricity generation and storage to the grid. Power generation and ES technologies need to have sufficient detail in the modeling process. For example, ES degradation is an important consideration for battery but not for thermal ES (Sections 3.2 and 3.3); this could greatly affect the modeling outcome.

A set of nonlinear simultaneous power balance equations in the form of Equation (7) needs to be solved to ensure feasible system operation.

Let t be the hour of the day $t = \{1, 2, \dots, T\}$ and $T = 24$, u be the renewable scenario $u = \{1, 2, \dots, U\}$ from renewable scenario reduction, and j be the system busbar number $j = \{1, 2, \dots, J\}$. Each scenario consists of one day's worth of data per year. The power flow on the PQ bus is given in Equation (7):

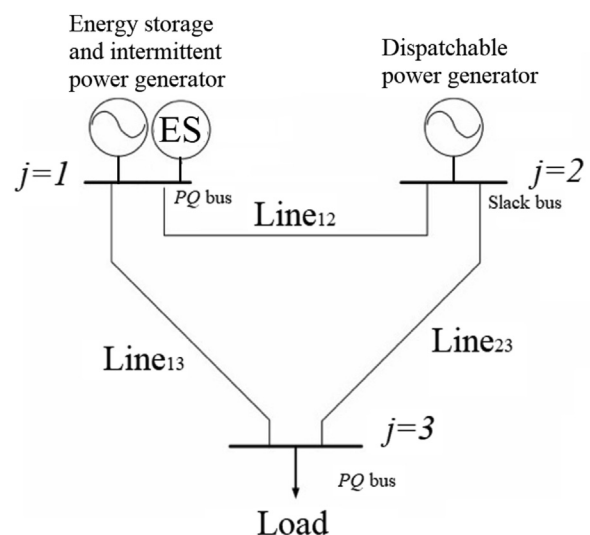

Fig. 8. A 3-bus system with two generators and a load.

$$P_{n,u,t,j} = \sum_{\substack{k=1 \\ k \neq j}}^J |V_j| |V_k| (G_{j,k} \cos \theta_{j,k} + B_{j,k} \sin \theta_{j,k})_{n,u,t}$$

$$\forall t \in T \quad \forall j \in J \quad \forall n \in N \quad \forall u \in U, \quad (7)$$

where $\theta_{j,k}$ is the difference in voltage angle (degrees) between busbars j and k , $G_{j,k}$ and $B_{j,k}$ are the conductance (Siemens) and susceptance (Siemens), respectively, for the transmission line between busbars j and k (Lai and Ma, 1997; Ma and Lai, 1996), and n is the year $n = \{1, 2, \dots, N\}$. The system LCOE can be calculated with Equation (8):

$$f_1 = \frac{\text{Capital cost} + \sum_{n=0}^N \frac{\sum_{u=1}^U S_u \left(\sum_{t=1}^T \sum_{j=1}^J O_{n,u,t,j} P_{n,u,t,j} \right)}{(1+d)^n}}{\sum_{n=0}^N \frac{\sum_{u=1}^U S_u \left(\sum_{t=1}^T \sum_{j=1}^J P_{n,u,t,j} \right)}{(1+d)^n}}, \quad (8)$$

where d is the discount rate (%), $\sum_{u=1}^U S_u = 365$ where S_u is the cardinality, that is, the number of days in cluster u , where each cluster represents a different scenario. The levelized cost of storage can be calculated using a similar approach to that given in Equation (2), where only storage output power and cost are considered in $P_{n,u,t,j}$ and $O_{n,u,t,j}$, respectively. The system's total carbon dioxide emissions can be calculated with a mathematical relationship linking power production and generator emissions (Wang and Singh, 2009) as given below:

$$f_2 = \sum_n^N \sum_u^U S_u \sum_t^T \sum_j^J \text{EM}_{\text{Total},n,u,t,j}. \quad (9)$$

By assuming that one type of carbon-emitting generator is connected to the busbar, $\text{EM}_{\text{Total},n,u,t,j}$ (emissions contribution) is given as:

$$\text{EM}_{\text{Total},n,u,t,j} = \delta + \gamma P_{n,u,t,j} + \alpha P_{n,u,t,j}^2, \quad (10)$$

where δ , γ , and α are constants obtained from the generator emissions curve. An energy index of reliability can be calculated from expected energy not served (Wang and Singh, 2009), as:

$$f_3 = \sum_n^N \sum_u^U S_u \sum_t^T \left(P_{\text{EES}_{\text{min}}} - P_{\text{ES},n,u,t} - P_{\text{Total},n,u,t} + P_{\text{Load},n,u,t} \right) \cdot X_{n,u,t} \quad (11)$$

$$X_{n,u,t} = \begin{cases} 1, & P_{\text{Supply}} \geq P_{\text{Load}} \\ 0, & \text{otherwise,} \end{cases} \quad (12)$$

$$(13)$$

where $P_{\text{EES}_{\text{min}}}$ (kW) is the permissible minimum ES power, P_{ES} (kW) is the ES power, P_{Load} (kW) is the load, P_{Total} (kW) is the total power delivered by all generators, and P_{Supply} (kW) is the power supply for the system, namely, ES, import power, and generators. Since system reliability is affected by the balance between power supply and demand, the binary variable $X_{n,u,t}$ is used to represent whether the demand is completely met by supply.

6.3. Renewable uncertainties and cost implications for ES systems

ES economics are closely related to the energy input and output

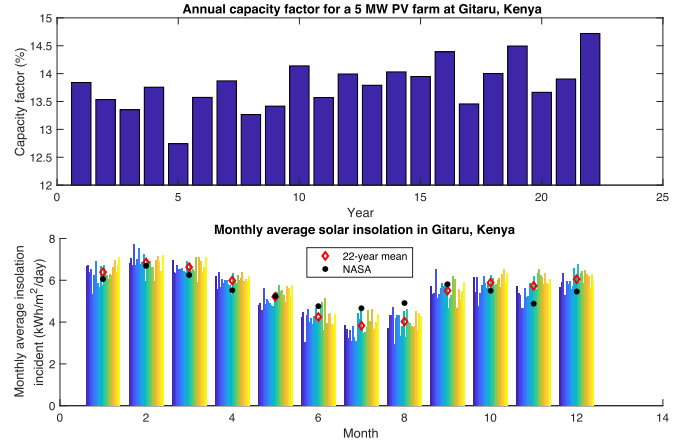

Fig. 9. The monthly average solar insolation and annual CF at a solar PV farm in Gitaru, Kenya.

(Lai and McCulloch, 2017). To elaborate on the LCOE metric proposed in Section 5.3, we present a case study on the LCOE of a PV system. We provide a discussion of the LCOE for ES, GIES, and non-GIES, and its dependence on the cost of renewable generation.

The case study was based on 22 years of solar irradiance data from Gitaru, Kenya. The data were obtained from Solargis. The sampling rate was one sample every 15 min. The economic study was based on a 5% discount rate, with the capital and operating costs of PV panels taken from Lai and McCulloch (2017). Fig. 9 presents the monthly average solar insolation and annual CF for a 5 MW PV farm. Due to atmospheric and climatic conditions, there was a clear trend to monthly insolation, with the maximum and minimum in February and July, respectively. Monthly insolation differed from year to year and, over the 22 years, the annual CF varied by no more than 1.9%.

Fig. 10 presents the LCOE adopted from Equations (2) and (3) for the solar PV farm. Based on the mean value, the two methods give a difference in LCOE of 0.024 \$/kWh. As discussed in Section 5.3, the discrepancy in calculated values of LCOE arises due to differences in the accounting of the solar energy surplus and the energy that is used directly.

According to the definition of levelized cost of delivery (Lai and McCulloch, 2017), the LCOE for ES (and non-GIES systems, for example, PV and battery) should consider the cost of electricity generation, that is, the surplus electricity; this will increase the LCOE for ES. The LCOE for GIES systems needs to be examined and represents a gap in knowledge. Following the above case study, we examined the relationship between renewable uncertainties and ES (also applicable for GIES and non-GIES).

7. Discussion

The current electrical power system models with a long-term focus mostly neglect transmission restrictions as well as the physical characteristics of power transmission. Thus, accurate load flow modeling will be a key factor in future energy models. As such, this is a particular issue for conducting long-term planning with large-scale ES. ES improves the power system operation by mitigating short-term negative phenomena (e.g., due to intermittent power generation). LEPSMs need to be able to represent all relevant techno-economical characteristics of the power supply system in a sufficiently detailed way. For technologies, the long-term ES costs and grid benefits (e.g., voltage enhancement) can be realized with a power flow model and discounted cash flow models (Lai et al.,

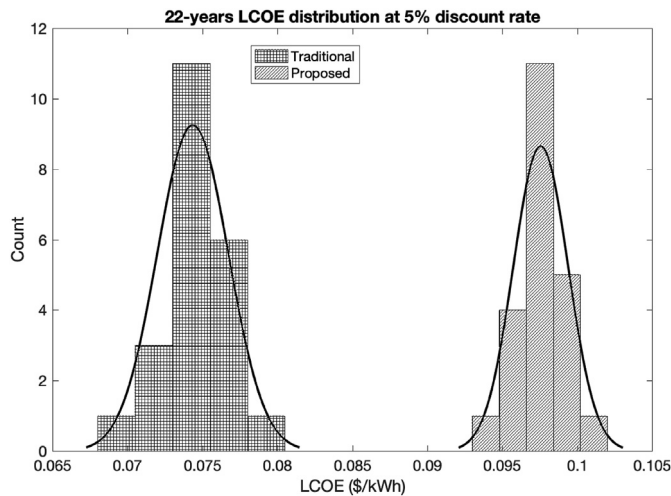

Fig. 10. LCOEs for PV with traditional and proposed methods.

2019b). The investment value of ES can be enhanced by analyzing the risks and options, for example, the option to defer, abandon, or expand an ES investment. Real options analysis can provide design flexibility as the investment timing can be chosen (Loureiro et al., 2015), and this approach is useful for evaluating storage in electrical power system modeling. Locatelli et al. (2016) proposed and examined a real options analysis method to study the investment value of ES. They emphasized that the risks and profitability were due to the following five factors: electricity price uncertainty, natural gas price increases, incentives, construction delays, and costs overruns. Real options analyses in electrical power system modeling, in particular for ES investment studies, are useful. Cost and revenue studies for ES can be different due to the system context, for example, for on-grid or off-grid applications (Kyriakopoulos and Arabatzis, 2016; Liu et al., 2018).

Driven by the challenges described in this paper, we have proposed a framework for LEPSM, named the Long-term power flow Electrical Power System Framework (LEPSF), to investigate the technological, environmental, and economic feasibility of electrical power systems with low-carbon power generation as well as generation-integrated and non-generation-integrated ES. This framework considers policy constraints, energy mixes, allowances for carbon dioxide emissions, and minimum required levels of energy security.

LEPSF integrates phenomena occurring at shorter time scales, that is, system operation such as power balancing, into the longer timescales as those in system planning. Stochastic properties hinder the analysis accuracy and lead to the question of how to explicitly model the uncertainty at both scales while computational tractability is maintained (Seljom and Tomasgard, 2015). The “no free lunch” theorem exists for the model accuracy and computation time, where a compromise is necessary.

The framework aims to:

1. Give a comparison of ES (including GIES and non-GIES) alternatives to meet the energy agenda,
2. Find the optimal trade-off between system reliability and economic and environmental benefits with ES, and
3. Determine the optimal mix of ES systems, considering both GIES and non-GIES systems, to meet the energy agenda.

The practical and social implementations of the proposed framework are as follows:

Practical implementations: The development of technical

standards and best practices to perform techno-economic studies for ES systems. International standards are created by international organizations and global experts to enforce the best practices to benchmark functional and technical performance. Standards make sure that technologies used by the public are efficient, safe, and integrated. Standards developed by the International Organization for Standardization are used in many domains, including environmental management, energy management, and information technology security (Standards). The Institute of Electrical and Electronics Engineers also publishes international standards. One particularly relevant example is “P2814 Techno-economic Metrics Standard for Hybrid Energy and Storage Systems”, which aims to formulate metrics to evaluate the technical and economic value of ES systems and low-carbon energy systems (“P2814 - Techno-economics, 2814”). The proposed framework can help to shape this novel standard by developing a methodology for techno-economic appraisal of novel GIES technologies.

Social implementation: Access to affordable and reliable electricity for all is a key element of UN Sustainable Development Goal 7. Electricity is a basic element of social progress that powers the information and communication technologies behind much of modern education and work. To be socially sustainable, electricity needs to be affordable (particularly for the most disadvantaged sections of the population) and reliable. The need to decarbonize the power sector must reflect these social implications. Solutions only at “plant level” or “user level” are unlikely to deliver the impact underpinning Sustainable Development Goal 7. A holistic approach based on the rethinking of the electrical power system modeling is needed. A key element of this new system will be the possibility to efficiently and effectively store a large amount of electricity. This will allow the integration of much needed renewable energy sources while ensuring that electricity is affordable and reliable for the entire population.

Some limitations of the current framework to be addressed in the future include:

- **Justification of the BDA technique:** Various data sources, including renewable energy resource, load demand, and market data, are required to conduct long-term electrical power system modeling. The review has provided several BDA techniques, including Fuzzy C-means and backward scenario reduction, to extract useful information from big data. Considering the accuracy and computational complexity, the optimal technique needs to be justified for the modeling.
- **Cost categorization of ES and low-carbon generation technologies:** Straightforward measures of purely technical merit combined with estimates of capital expenditure and operating expenditure are not sufficient when comparing different energy system options. The framework can be expanded with detailed cost inputs for various technologies. For example, the degradation cost for energy storage can differ greatly as with Lithium-ion batteries which are susceptible to degradation as compared with thermal storage.

In recent years, the types of grid services procured by the system and network operators have become increasingly diverse, and ES is one of the contributors. Grid services are a relevant area of study, particularly on the techno-economics of using ES for these services. Co-location of storage with demand is also a promising future research direction which can increase local energy consumption (Pimm et al., 2017). The identified future scope includes the following:

- **ES for transportation energy systems:** Global demand for EVs is increasing sharply to decarbonize the energy system. Zheng

et al. (2020) examined the yearly sales and market trends of EVs at the national and regional levels in China from 2011 to 2017, during which time EVs consumed 3 TWh of electricity and potentially saved over 600,000 tons of carbon emissions. It is evident that EVs can greatly affect the national and regional power system performance when a large amount of electricity is consumed or injected into the power system. Future work should examine how ES can provide technical and economic benefits to the heavily coupled transport-electricity system, including the deployment of rapid EV charging stations.

- ES for multi-vector energy systems and demand response:** Heat energy constitutes a large proportion of energy consumption for several countries, such as Finland and the UK (Leurent et al., 2017). Whole energy systems incorporate multiple energy types, which include gas, heat, and electricity, to optimally meet different energy demands. ES selection is affected by the type of energy demand to be fulfilled and the economic and technical merits of the different storage technologies (Zhang et al., 1109). Demand response is a variation in the consumer's power consumption to improve the balance between demand and supply. Wang et al. (Wanget al., 2019) stated that large-scale controllable air conditioning can contribute to distribution network operation through demand response methods. They proposed a two-stage optimal scheduling technique for a distribution system with PV systems, air conditioning loads, and batteries. The day-ahead stage aims to minimize operating costs, and the real-time stage minimizes the imbalance cost between the real-time energy market and day-ahead energy market. The scheduling technique considers random intra-day variation in PV generation, consumer load, and price of electricity. Optimal scheduling can reduce peak demand and operating cost as well as increase the PV penetration level in the distribution network.
- Quantifying resilient energy systems from the techno-economic perspective:** Energy system resilience is generally defined as the ability of an electrical power system to return to normal operating conditions after a disturbance or to adapt to unexpected events (Wang et al., 2018). Present resilience studies focus primarily on technical aspects, including minimizing the loss of load probability. Future work should consider how to quantify energy system resilience from the techno-economic perspective with the use of various ES technologies (El Rahi et al., 2016; Farraj et al., 2018; Rde et al., 2018).

8. Conclusions

The amount of ES capacity in power systems will continue to increase with the increase of low-carbon power generation. Thus, ES will be extremely important in future electrical power systems for energy arbitrage and grid services, for example, in mitigating system failure due to variability in demand and generation. In the context of GIES for provision of firm low-carbon power, emerging alternatives to electrochemical ES, such as mechanical and thermal ES, have been presented.

There is a need to reassess the impacts on the system with the advent of several intermittent power generation technologies and ES decision-making from a long-term perspective. This paper proposes the LEPSF that could be of great relevance for future technical, economic, policy, and environmental studies for GIES and non-GIES. LEPSF adopts power flow analysis with scenario reduction for generation data and the ABM of energy consumption. Data analytics (e.g., cluster analysis) and energy consumer behavior are the main components of LEPSF.

Our comprehensive review of the current electrical power

system models determined that integrating a long-term and short-term study timeframe is a key issue. Electrical power systems are subject to increasing operational and planning uncertainties. From the system cost perspective, we discussed the levelized cost of electricity for renewables and provided an example for solar energy, showing that simple averaging metrics can hinder a credible energy study. The economics of ES, in particular, GIES and non-GIES, are dependent on the generation source. Also, BDA offers potential solutions in addressing the modeling challenges by capturing the uncertainty in power generation and demand.

The optimal energy storage mix to maximize exergy efficiency and environmental benefits for regional and national energy systems is an ongoing research goal. This paper paves the way for several important future investigations in the context of electrical power system modeling for ES and GIES.

Declaration of competing interest

The authors declare that they have no known competing financial interests or personal relationships that could have appeared to influence the work reported in this paper.

Acknowledgements

This work is supported by the EPSRC grant "GIES: Generation Integrated Energy Storage: A Paradigm Shift" (EP/P022049/1), particularly for the work performed by Dr. C. S. Lai, Prof. G. Locatelli, and Dr. A. Pimm.

The work is also supported by the Department of Finance and Education of Guangdong Province (2016) [202]: Key Discipline Construction Program, China; and the Education Department of Guangdong Province: New and Integrated Energy System Theory and Technology Research Group [Project Number 2016KCXTD022], particularly for the work performed by Ms. X. Wu and Prof. L. L. Lai. Dr. C. S. Lai also acknowledges the funding to attend the 10th International Conference on Applied Energy (ICAE 2018) which benefited this work.

References

- Energy storage, 2020. International Energy Agency (IEA) [Online]. Available. <https://www.iea.org/reports/energy-storage>.
- A comparison of the TIMES and MARKAL models [Online]. Available. <https://iea-etsap.org/tools/TIMESvsMARKAL.pdf>.
- PLEXOS by Energy Exemplar: Electricity, 2017. Energy Exemplar. [Online]. Available. https://energyexemplar.com/wp-content/uploads/PLEXOS_Electricity_2017.pdf.
- Future Energy Scenarios: GB Gas and Electricity Transmission, 2016. National Grid [Online]. Available. <http://fes.nationalgrid.com/fes-document/>.
- GridView: Simulate Security-Constrained Unit Commitment and Economic Dispatch in Large-Scale Transmission Networks, 2016. ABB [Online]. Available. https://new.abb.com/docs/librariesprovider139/default-document-library/gridview_brochure.pdf?sfvrsn=4.
- Long-range Energy Alternatives Planning System: User Guide for LEAP Version 2008, 2010. Stockholm Environment Institute [Online]. Available. <https://www.energycommunity.org/documents/Leap2008UserGuideEnglish.pdf>.
- PJM Renewable Integration Study: Task 3A Part A, Modelling and Scenarios," PJM Interconnection, 2014. LCC and General Electric International, Inc [Online]. Available. <https://www.pjm.com/-/media/committees-groups/subcommittees/irs/postings/pjm-pris-task-3a-part-a-modeling-and-scenarios.ashx?1a=en>.
- Open source energy modelling system [Online]. Available. <http://www.osemosys.org/>.
- P2814 - Techno-Economics Metrics Standard for Hybrid Energy and Storage Systems, 2019. IEEE Standards Association [Online]. Available. <https://standards.ieee.org/project/2814.html>.
- PowerFactory Applications, 2019. DigSilent PowerFactory [Online]. Available. <https://www.digsilent.de/en/powerfactory.html>.
- ABB PROMOD IV Technical Overview: the Premier Integrated Electric Generation and Transmission Market Simulation System, 2015 [Online]. Available. https://new.abb.com/docs/librariesprovider139/default-document-library/promod-iv-technical-overview_br.pdf?sfvrsn=2.
- DOE/EIA-0581 The National Energy Modelling System: an Overview 2009, 2009. Energy Information Administration [Online]. Available. <https://www.eia.gov>

- outlooks/aeo/nems/overview/pdf/0581(2009).pdf.
 AURORA v13.1 [Online]. Available: <http://epis.com/aurora/aurora.php>.
- Abe, Y.Y., Takahashi, Y., Kanari, K., Kamimoto, M., Sakamoto, R., Ozawa, T., 1986. Molten salt latent thermal energy storage for load following generation in nuclear power plants. In: In Proceedings of the 21st Intersociety Energy Conversion Engineering Conference, vol. 18 [Online]. Available: <https://inis.iaea.org/search/SingleRecord.aspx?recordsFor=SingleRecord&RN=18042318>.
- Adepetu, A., Keshav, S., Arya, V., 2016. An agent-based electric vehicle ecosystem model: San Francisco case study. *Transport Pol.* 46, 109–122.
- Aguado, J., de la Torre, S., Triviño, A., 2017. Battery energy storage systems in transmission network expansion planning. *Elec. Power Syst. Res.* 145, 63–72.
- Akhavan-Hejazi, H., Mohsenian-Rad, H., 2018. Power systems big data analytics: an assessment of paradigm shift barriers and prospects. *Energy Rep.* 4, 91–100.
- Alahakoon, D., Yu, X., 2016. Smart electricity meter data intelligence for future energy systems: a survey. *IEEE Transactions on Industrial Informatics* 12 (1), 425–436.
- Amirante, R., Cassone, E., Distaso, E., Tamburrano, P., 2017. Overview on recent developments in energy storage: mechanical, electrochemical and hydrogen technologies. *Energy Convers. Manag.* 132, 372–387.
- Andoni, M., Robu, V., Früh, W.-G., Flynn, D., 2017. Game-theoretic modeling of curtailment rules and network investments with distributed generation. *Appl. Energy* 201, 174–187.
- Antonelli, M., Barsali, S., Desideri, U., Giglioli, R., Paganucci, F., Pasini, G., 2017. Liquid air energy storage: potential and challenges of hybrid power plants. *Appl. Energy* 194, 522–529.
- Aslani, A., Wong, K.-F.V., 2014. Analysis of renewable energy development to power generation in the United States. *Renew. Energy* 63, 153–161.
- Aydin, D., Casey, S.P., Riffat, S., 2015. The latest advancements on thermochemical heat storage systems. *Renew. Sustain. Energy Rev.* 41, 356–367.
- Barrows, C., Mai, T., Hale, E., Lopez, A., Eurek, K., 2015. Considering renewables in capacity expansion models: capturing flexibility with hourly dispatch. In: *Power & Energy Society General Meeting*, 2015. IEEE, pp. 1–5 (IEEE).
- Bayon, A., et al., 2018. Techno-economic assessment of solid-gas thermochemical energy storage systems for solar thermal power applications. *Energy* 149, 473–484.
- Benato, A., 2017. Performance and cost evaluation of an innovative Pumped Thermal Electricity Storage power system. *Energy* 138, 419–436.
- Benato, A., Stoppato, A., 2018. Pumped thermal electricity storage: a technology overview. *Thermal Science and Engineering Progress* 6, 301–315.
- Berrada, A., Loudiyi, K., Zorkani, I., 2017a. Profitability, risk, and financial modeling of energy storage in residential and large scale applications. *Energy* 119, 94–109.
- Berrada, A., Loudiyi, K., Zorkani, I., 2017b. System design and economic performance of gravity energy storage. *J. Clean. Prod.* 156, 317–326.
- Blair, N., Zhou, E., Getman, D., Arent, D.J., 2015. Electricity Capacity Expansion Modeling, Analysis, and Visualization: A Summary of High-Renewable Modeling Experiences. National Renewable Energy Lab (NREL) [Online]. Available: <https://www.nrel.gov/docs/fy16osti/64831.pdf>.
- Boston, A., Thomas, H., 2015. "Managing flexibility whilst decarbonising the GB electricity system. *ERP report*. [Online]. Available: <http://erpuk.org/wp-content/uploads/2015/08/ERP-Flex-Man-Full-Report.pdf>.
- Braff, W.A., Mueller, J.M., Trancik, J.E., 2016. Value of storage technologies for wind and solar energy. *Nat. Clim. Change* 6, 964–969.
- Bueno, C., Carta, J.A., 2006. Wind powered pumped hydro storage systems, a means of increasing the penetration of renewable energy in the Canary Islands. *Renew. Sustain. Energy Rev.* 10 (4), 312–340.
- Cárdenas, B., Pimm, A.J., Kantharaj, B., Simpson, M., Garvey, J., Garvey, S.D., 2017. Lowering the cost of large-scale energy storage: high temperature adiabatic compressed air energy storage. *Propulsion and Power Research* 6 (2), 126–133.
- Cavallo, A., 2007. Controllable and affordable utility-scale electricity from intermittent wind resources and compressed air energy storage (CAES). *Energy* 32 (2), 120–127.
- Chadee, X.T., Clarke, R.M., 2017. Wind resources and the levelized cost of wind generated electricity in the Caribbean islands of Trinidad and Tobago. *Renew. Sustain. Energy Rev.* 81, 2526–2540.
- Chen, Y.-T., 2017. The factors affecting electricity consumption and the consumption characteristics in the residential sector—a case example of Taiwan. *Sustainability* 9 (8), 1484.
- Chen, W.-H., Wu, P.-H., Wang, X.-D., Lin, Y.-L., 2016. Power output and efficiency of a thermoelectric generator under temperature control. *Energy Convers. Manag.* 127, 404–415.
- Chen, K., He, Z., Wang, S.X., Hu, J., Li, L., He, J., 2018. Learning-based data analytics: moving towards transparent power grids. *CSEE Journal of Power and Energy Systems* 4 (1), 67–82.
- Coss, S., Rebillard, C., Verda, V., Le Corre, O., 2017. Sustainability assessment of energy services using complex multi-layer system models. *J. Clean. Prod.* 142, 23–38.
- Darling, S.B., You, F., Veselka, T., Velosa, A., 2011. Assumptions and the levelized cost of energy for photovoltaics. *Energy Environ. Sci.* 4 (9), 3133–3139.
- Davenne, T., Garvey, S., Cardenas, B., Simpson, M., 2017. The cold store for a pumped thermal energy storage system. *Journal of Energy Storage* 14, 295–310.
- de Boer, H.S.H., van Vuuren, D.D., 2017. Representation of variable renewable energy sources in TIMER, an aggregated energy system simulation model. *Energy Econ.* 64, 600–611.
- de Durana, J.M.G., Barambones, O., Kremers, E., Varga, L., 2014. Agent based modeling of energy networks. *Energy Convers. Manag.* 82, 308–319.
- Deane, J., Chiodi, A., Gargiulo, M., Gallachóir, B.P.Ó., 2012. Soft-linking of a power systems model to an energy systems model. *Energy* 42 (1), 303–312.
- DeCarolis, J., et al., 2017. Formalizing best practice for energy system optimization modelling. *Appl. Energy* 194, 184–198.
- Dhand, A., Pullen, K., 2015. Analysis of continuously variable transmission for flywheel energy storage systems in vehicular application. *Proc. IME C J. Mech. Eng. Sci.* 229 (2), 273–290.
- Diakov, V., Cole, W., Sullivan, P., Brinkman, G., Margolis, R., 2015. Improving Power System Modeling: A Tool to Link Capacity Expansion and Production Cost Models. National Renewable Energy Laboratory (NREL) [Online]. Available: <https://www.nrel.gov/docs/fy16osti/64905.pdf>.
- Dutta, P., 2017. High temperature solar receiver and thermal storage systems. *Appl. Therm. Eng.* 124, 624–632.
- El Rahi, G., Sanjab, A., Saad, W., Mandayam, N.B., Poor, H.V., 2016. Prospect theory for enhanced smart grid resilience using distributed energy storage. In: *Communication, Control, and Computing (Allerton)*, 2016 54th Annual Allerton Conference on. IEEE, pp. 248–255.
- Farraj, A., Hammad, E., Kundur, D., 2018. Storage-based multi-agent regulation framework for smart grid resilience. *IEEE Transactions on Industrial Informatics* 14, 3859–3869.
- Fichter, T. Energy system model REMix [Online]. Available: https://www.dlr.de/Portaldata/41/Resources/dokumente/institut/system/Modellbeschreibungen/DLR_Energy_System_Model_REMix_short_description_2016.pdf.
- Garbrecht, O., Bieber, M., Kneer, R., 2017. Increasing fossil power plant flexibility by integrating molten-salt thermal storage. *Energy* 118, 876–883.
- García-Gusano, D., Espegren, K., Lind, A., Kirkengen, M., 2016. The role of the discount rates in energy systems optimisation models. *Renew. Sustain. Energy Rev.* 59, 56–72.
- Gargiulo, M., Gallachóir, B.Ó., 2013. Long-term energy models: principles, characteristics, focus, and limitations. *Wiley Interdisciplinary Reviews: Energy Environ.* 2 (2), 158–177.
- Garvey, S.D., et al., 2015a. On generation-integrated energy storage. *Energy Pol.* 86, 544–551.
- Garvey, S.D., et al., 2015b. Analysis of a wind turbine power transmission system with intrinsic energy storage capability. *Wind Eng.* 39 (2), 149–173.
- Gerst, M.D., et al., 2013. Agent-based modeling of climate policy: an introduction to the ENGAGE multi-level model framework. *Environ. Model. Software* 44, 62–75.
- Ghorbani, B., Mehrpooya, M., Ardehali, A., 2020. Energy and exergy analysis of wind farm integrated with compressed air energy storage using multi-stage phase change material. *J. Clean. Prod.* 259, 120906.
- Growe-Kuska, N., Heitsch, H., Romisch, W., 2003. Scenario reduction and scenario tree construction for power management problems. In: *Power Tech Conference Proceedings, 2003 IEEE Bologna*, vol. 3. IEEE, p. 7.
- Guerini, M., Moneta, A., 2017. A method for agent-based models validation. *J. Econ. Dynam. Contr.* 82, 125–141.
- Guo, Z., Zhou, K., Zhang, C., Lu, X., Chen, W., Yang, S., 2018. Residential electricity consumption behavior: influencing factors, related theories and intervention strategies. *Renew. Sustain. Energy Rev.* 81, 399–412.
- Hall, L.M., Buckley, A.R., 2016. A review of energy systems models in the UK: prevalent usage and categorisation. *Appl. Energy* 169, 607–628.
- Hebner, R., Beno, J., Walls, A., 2002. Flywheel batteries come around again. *IEEE Spectrum* 39 (4), 46–51.
- Heylen, E., Labeuw, W., Deconinck, G., Van Hertem, D., 2016. Framework for evaluating and comparing performance of power system reliability criteria. *IEEE Trans. Power Syst.* 31 (6), 5153–5162.
- Hu, J., Morais, H., Lind, M., Bindner, H.W., 2016. Multi-agent based modeling for electric vehicle integration in a distribution network operation. *Elec. Power Syst. Res.* 136, 341–351.
- Iranzo, A., Suárez, C., Guerra, J., 2018. Mixing enhancement in thermal energy storage molten salt tanks. *Energy Convers. Manag.* 168, 320–328.
- Ji, W., Zhou, Y., Sun, Y., Zhang, W., An, B., Wang, J., 2017. Thermodynamic analysis of a novel hybrid wind-solar-compressed air energy storage system. *Energy Convers. Manag.* 142, 176–187.
- Joskow, P.L., 2011. Comparing the costs of intermittent and dispatchable electricity generating technologies. *Am. Econ. Rev.* 101 (3), 238–241.
- Kang, C., Wang, Y., Xue, Y., Mu, G., Liao, R., 2018. Big data analytics in China's electric power industry: modern information, communication technologies, and millions of smart meters. *IEEE Power Energy Mag.* 16 (3), 54–65.
- Kannan, R., Turton, H., 2013. A long-term electricity dispatch model with the TIMES framework. *Environ. Model. Assess.* 18 (3), 325–343.
- Kantharaj, B., Garvey, S., Pimm, A., 2015a. Thermodynamic analysis of a hybrid energy storage system based on compressed air and liquid air. *Sustainable Energy Technologies and Assessments* 11, 159–164.
- Kantharaj, B., Garvey, S., Pimm, A., 2015b. Compressed air energy storage with liquid air capacity extension. *Appl. Energy* 157, 152–164.
- Kapsali, M., Anagnostopoulos, J., Kaldellis, J., 2012. Wind powered pumped-hydro storage systems for remote islands: a complete sensitivity analysis based on economic perspectives. *Appl. Energy* 99, 430–444.
- Khuntia, S.R., Tuinema, B.W., Rueda, J.L., van der Meijden, M.A., 2016. Time-horizons in the planning and operation of transmission networks: an overview. *IET Gener., Transm. Distrib.* 10 (4), 841–848.
- Klinge Jacobsen, H., 1998. Integrating the bottom-up and top-down approach to

- energy–economy modelling: the case of Denmark. *Energy Econ.* 20 (4), 443–461.
- Korsavi, S.S., Zomorodian, Z.S., Tahsildoost, M., 2018. Energy and economic performance of rooftop PV panels in the hot and dry climate of Iran. *J. Clean. Prod.* 174, 1204–1214.
- Krawczyk, P., Szablowski, Ł., Karellas, S., Kakaras, E., Badyda, K., 2018. Comparative thermodynamic analysis of compressed air and liquid air energy storage systems. *Energy* 142, 46–54.
- Krupke, C., Wang, J., Clarke, J., Luo, X., 2017. Modeling and experimental study of a wind turbine system in hybrid connection with compressed air energy storage. *IEEE Trans. Energy Convers.* 32 (1), 137–145.
- Kyriakopoulos, G.L., Arabatzis, G., 2016. Electrical energy storage systems in electricity generation: energy policies, innovative technologies, and regulatory regimes. *Renew. Sustain. Energy Rev.* 56, 1044–1067.
- Laes, E., Couder, J., 2014. Probing the usefulness of technology-rich bottom-up models in energy and climate policies: lessons learned from the Forum project. *Futures* 63, 123–133.
- Lai, L.L., 1998. Intelligent system applications in power engineering: evolutionary programming and neural networks. John Wiley & Sons, Inc. 1–286.
- Lai, C.S., 2017. Hybridisation of High Penetration Photovoltaic, Anaerobic Digestion Biogas Power Plant and Electrical Energy Storage. D.Phil. thesis. Department of Engineering Science, University of Oxford [Online]. Available. <https://ora.ox.ac.uk/objects/uid:d2935f9e-d560-4b01-b040-8bd3f1beb121>.
- Lai, L.L., Ma, J., 1997. Application of evolutionary programming to reactive power planning—comparison with nonlinear programming approach. *IEEE Trans. Power Syst.* 12 (1), 198–206.
- Lai, C.S., McCulloch, M.D., 2017. Levelized cost of electricity for solar photovoltaic and electrical energy storage. *Appl. Energy* 190, 191–203.
- Lai, C.S., Jia, Y., Lai, L.L., Xu, Z., McCulloch, M.D., Wong, K.P., 2017a. A comprehensive review on large-scale photovoltaic system with applications of electrical energy storage. *Renew. Sustain. Energy Rev.* 78, 439–451.
- Lai, C.S., Jia, Y., McCulloch, M.D., Xu, Z., 2017b. Daily clearness index profiles cluster analysis for photovoltaic system. *IEEE Transactions on Industrial Informatics* 13 (5), 2322–2332.
- Lai, C.S., Locatelli, G., Pimm, A., Li, X., Lai, L.L., 2018. Levelized cost of electricity with storage degradation. Ningbo, China. In: Presented at the Offshore Energy and Storage Summit [Online]. Available. <http://eprints.whiterose.ac.uk/132105/>.
- Lai, C.S., Locatelli, G., Pimm, A., Li, X., Lai, L.L., 2019a. Levelized cost of electricity considering electrochemical energy storage cycle-life degradations. *Energy Procedia* 158, 3308–3313.
- Lai, C.S., Locatelli, G., Pimm, A., Tao, Y., Li, X., Lai, L.L., 2019b. A financial model for lithium-ion storage in a photovoltaic and biogas energy system. *Appl. Energy* 251, 113179.
- Lai, C.S., et al., 2017. Levelized cost of electricity for photovoltaic/biogas power plant hybrid system with electrical energy storage degradation costs. *Energy Convers. Manag.* 153, 34–47.
- Lee, D., Baldick, R., 2017. Load and wind power scenario generation through the generalized dynamic factor model. *IEEE Trans. Power Syst.* 32 (1), 400–410.
- Leurent, M., Jasserand, F., Locatelli, G., Palm, J., Rämä, M., Trianni, A., 2017. Driving forces and obstacles to nuclear cogeneration in Europe: lessons learnt from Finland. *Energy Pol.* 107, 138–150.
- Li, G., 2016. Sensible heat thermal storage energy and exergy performance evaluations. *Renew. Sustain. Energy Rev.* 53, 897–923.
- Li, Y., Lukso, Z., Weijnen, M., 2016a. The impact of inter-regional transmission grid expansion on China's power sector decarbonization. *Appl. Energy* 183, 853–873.
- Li, J., Lan, F., Wei, H., 2016b. A scenario optimal reduction method for wind power time series. *IEEE Trans. Power Syst.* 31 (2), 1657–1658.
- Li, C., Chaudhary, S.K., Savaghebi, M., Vasquez, J.C., Guerrero, J.M., 2016c. Power flow analysis for low-voltage AC and DC microgrids considering droop control and virtual impedance. *IEEE Transactions on Smart Grid* 8 (6), 2754–2764.
- Li, Y., et al., 2014. Load shifting of nuclear power plants using cryogenic energy storage technology. *Appl. Energy* 113, 1710–1716.
- Lin, C., Fang, C., Chen, Y., Liu, S., Bie, Z., 2017. Scenario generation and reduction methods for power flow examination of transmission expansion planning. In: *Power and Energy Systems (ICPES), 2017 IEEE 7th International Conference on*. IEEE, pp. 90–95.
- Y. Liu and J.-I. Du, "A multi criteria decision support framework for renewable energy storage technology selection," *J. Clean. Prod.* doi.org/10.1016/j.jclepro.2020.122183.
- Liu, C., Cheng, M.-S., Zhao, B.-C., Dai, Z.-M., 2017. A wind power plant with thermal energy storage for improving the utilization of wind energy. *Energies* 10 (12), 2126.
- Liu, Y., Yu, S., Zhu, Y., Wang, D., Liu, J., 2018. Modeling, planning, application and management of energy systems for isolated areas: a review. *Renew. Sustain. Energy Rev.* 82, 460–470.
- Locatelli, G., Invernizzi, D.C., Mancini, M., 2016. Investment and risk appraisal in energy storage systems: a real options approach. *Energy* 104, 114–131.
- Loulou, Richard, Goldstein, Gary, Amit, Kanudia, Lettila, Antti, Remme, Uwe, 2016. Documentation for the TIMES Model: Part I [Online]. Available. https://iea-etsap.org/docs/Documentation_for_the_TIMES_Model-Part-I_July-2016.pdf.
- Loureiro, M.V., Claro, J., Pereira, P.J., 2015. Capacity expansion in transmission networks using portfolios of real options. *Int. J. Electr. Power Energy Syst.* 64, 439–446.
- Lunz, B., et al., 2016. Scenario-based comparative assessment of potential future electricity systems—A new methodological approach using Germany in 2050 as an example. *Appl. Energy* 171, 555–580.
- Luo, X., Wang, J., Dooner, M., Clarke, J., 2015. Overview of current development in electrical energy storage technologies and the application potential in power system operation. *Appl. Energy* 137, 511–536.
- Ma, J., Lai, L.L., 1996. Evolutionary programming approach to reactive power planning. *IEE Proc. Generat. Transm. Distrib.* 143 (4), 365–370.
- Ma, T., Nakamori, Y., 2009. Modeling technological change in energy systems—from optimization to agent-based modeling. *Energy* 34 (7), 873–879.
- Ma, X.-Y., Sun, Y.-Z., Fang, H.-L., 2013. Scenario generation of wind power based on statistical uncertainty and variability. *IEEE Transactions on Sustainable Energy* 4 (4), 894–904.
- Ma, T., Yang, H., Lu, L., Peng, J., 2014. Technical feasibility study on a standalone hybrid solar-wind system with pumped hydro storage for a remote island in Hong Kong. *Renew. Energy* 69, 7–15.
- Ma, T., Yang, H., Lu, L., Peng, J., 2015. Pumped storage-based standalone photovoltaic power generation system: modeling and techno-economic optimization. *Appl. Energy* 137, 649–659.
- MacDonald, P., Moore, C., 2020. The burning question: should the UK end tax breaks on burning wood for power? Emberiza [Online]. Available. <https://ember-climate.org/project/the-burning-question/>.
- Mahmud, K., Town, G.E., 2016. A review of computer tools for modeling electric vehicle energy requirements and their impact on power distribution networks. *Appl. Energy* 172, 337–359.
- Mai, Trieu, Drury, Easan, Kelly, Eureka, Bodington, Natalie, Lopez, Anthony, Perry, Andrew, 2013. Resource Planning Model: an Integrated Resource Planning and Dispatch Tool for Regional Electric Systems. NREL/TP-6A20-56723. National Renewable Energy Laboratory [Online]. Available. <https://www.nrel.gov/docs/fy13osti/56723.pdf>.
- Mangialardi, L., Mantriota, G., 1992. The advantages of using continuously variable transmissions in wind power systems. *Renew. Energy* 2 (3), 201–209.
- McPherson, M., Tahseen, S., 2018. Deploying storage assets to facilitate variable renewable energy integration: the impacts of grid flexibility, renewable penetration, and market structure. *Energy* 145, 856–870.
- Min, D., Ryu, J.-h., Choi, D.G., 2018. A long-term capacity expansion planning model for an electric power system integrating large-size renewable energy technologies. *Comput. Oper. Res.* 96, 244–255.
- Mischke, P., Karlsson, K.B., 2014. Modelling tools to evaluate China's future energy system—a review of the Chinese perspective. *Energy* 69, 132–143.
- Moser, M., Gils, H.-C., Pivaro, G., 2020. A sensitivity analysis on large-scale electrical energy storage requirements in Europe under consideration of innovative storage technologies. *J. Clean. Prod.* 269, 122261.
- NREL Wind Prospector, 2018. NREL [Online]. Available. <https://maps.nrel.gov/wind-prospector/>.
- Obi, M., Jensen, S., Ferris, J.B., Bass, R.B., 2017. Calculation of levelized costs of electricity for various electrical energy storage systems. *Renew. Sustain. Energy Rev.* 67, 908–920.
- Okazaki, T., Shirai, Y., Nakamura, T., 2015. Concept study of wind power utilizing direct thermal energy conversion and thermal energy storage. *Renew. Energy* 83, 332–338.
- Olivella-Rosell, P., Villafafila-Robles, R., Sumper, A., Bergas-Jané, J., 2015. Probabilistic agent-based model of electric vehicle charging demand to analyse the impact on distribution networks. *Energies* 8 (5), 4160–4187.
- Park, H., Baldick, R., 2016. Multi-year stochastic generation capacity expansion planning under environmental energy policy. *Appl. Energy* 183, 737–745.
- Parrado, C., Girard, A., Simon, F., Fuentealba, E., 2016. 2050 LCOE (Levelized Cost of Energy) projection for a hybrid PV (photovoltaic)-CSP (concentrated solar power) plant in the Atacama Desert, Chile. *Energy* 94, 422–430.
- Paul, Anthony, Burtraw, Dallas, 2002. The RFF Haiku electricity market model. Resources for the Future, [Online]. Available. <http://www.rff.org/files/sharepoint/WorkImages/Download/RFF-RPT-haiku.pdf>.
- Pfenninger, S., Hawkes, A., Keirstead, J., 2014. Energy systems modeling for twenty-first century energy challenges. *Renew. Sustain. Energy Rev.* 33, 74–86.
- Pfenninger, S., et al., 2018. Opening the black box of energy modelling: strategies and lessons learned. *Energy Strategy Reviews* 19, 63–71.
- Pietrapertosa, F., et al., 2010. Assessment of externalities related to global and local air pollutants with the NEEDS-TIMES Italy model. *Renew. Sustain. Energy Rev.* 14 (1), 404–412.
- Pimm, A.J., Garvey, S.D., 2014. The economics of hybrid energy storage plant. *Int. J. Environ. Stud.* 71 (6), 787–795.
- Pimm, A.J., Garvey, S.D., Drew, R., 2011. Shape and cost analysis of pressurized fabric structures for subsea compressed air energy storage. *Proc. IME C J. Mech. Eng. Sci.* 225 (5), 1027–1043.
- Pimm, A.J., Garvey, S.D., de Jong, M., 2014. Design and testing of energy bags for underwater compressed air energy storage. *Energy* 66, 496–508.
- Pimm, A.J., Garvey, S.D., Kantharaj, B., 2015. Economic analysis of a hybrid energy storage system based on liquid air and compressed air. *Journal of Energy Storage* 4, 24–35.
- Pimm, A.J., Cockerill, T.T., Taylor, P.G., Bastiaans, J., 2017. The value of electricity storage to large enterprises: a case study on Lancaster University. *Energy* 128, 378–393.
- Poncelet, K., Delarue, E., Six, D., Duerinck, J., D'haeseleer, W., 2016. Impact of the level of temporal and operational detail in energy-system planning models. *Appl. Energy* 162, 631–643.
- Pratama, Y.W., et al., 2017. Multi-objective optimization of a multiregional

- electricity system in an archipelagic state: the role of renewable energy in energy system sustainability. *Renew. Sustain. Energy Rev.* 77, 423–439.
- Rai, V., Henry, A.D., 2016. Agent-based modelling of consumer energy choices. *Nat. Clim. Change* 6 (6), 556–562.
- Rose, A., Stoner, R., Pérez-Arriaga, I., 2016. Prospects for grid-connected solar PV in Kenya: a systems approach. *Appl. Energy* 161, 583–590.
- Rüde, T., Bösmann, A., Preuster, P., Wasserscheid, P., Arlt, W., Müller, K., 2018. Resilience of liquid organic hydrogen carrier based energy-storage systems. *Energy Technol.* 6 (3), 529–539.
- Scholz, Y., Gils, H.C., Pietzcker, R.C., 2017. Application of a high-detail energy system model to derive power sector characteristics at high wind and solar shares. *Energy Econ.* 64, 568–582.
- Sebastián, R., Alzola, R.P., 2012. Flywheel energy storage systems: review and simulation for an isolated wind power system. *Renew. Sustain. Energy Rev.* 16 (9), 6803–6813.
- Sedkaoui, S., 2018. *Data Analytics and Big Data*. John Wiley & Sons.
- Sejtom, P., Tomasgard, A., 2015. Short-term uncertainty in long-term energy system models—a case study of wind power in Denmark. *Energy Econ.* 49, 157–167.
- Shirley, R., Kammen, D., 2015. Energy planning and development in Malaysian Borneo: assessing the benefits of distributed technologies versus large scale energy mega-projects. *Energy Strategy Reviews* 8, 15–29.
- Short, Walter, et al., 2011. *Regional Energy Deployment System (ReEDS)*. NREL/TP-6A20-46534. National Renewable Energy Laboratory [Online]. Available. <https://www.nrel.gov/docs/fy12osti/46534.pdf>.
- Simoes, S., Zeyringer, M., Mayr, D., Huld, T., Nijts, W., Schmidt, J., 2017. Impact of different levels of geographical disaggregation of wind and PV electricity generation in large energy system models: a case study for Austria. *Renew. Energy* 105, 183–198.
- Smallbone, A., Jülich, V., Wardle, R., Roskilly, A.P., 2017. Levelised cost of storage for pumped heat energy storage in comparison with other energy storage technologies. *Energy Convers. Manag.* 152, 221–228.
- SolarGIS [Online]. Available. <http://solarGIS.info/doc/free-solar-radiation-maps-GHI>.
- Sommerfeldt, N., Madani, H., 2017. Revisiting the techno-economic analysis process for building-mounted, grid-connected solar photovoltaic systems: Part one—Review. *Renew. Sustain. Energy Rev.* 74, 1379–1393.
- Sorknæs, P., 2018. Simulation method for a pit seasonal thermal energy storage system with a heat pump in a district heating system. *Energy* 152, 533–538.
- Sossan, F., Nespoli, L., Medici, V., Paolone, M., 2018. Unsupervised disaggregation of photovoltaic production from composite power flow measurements of heterogeneous prosumers. *IEEE Transactions on Industrial Informatics* 14 (9), 3904–3913.
- Standards, 1947. International Organization for Standardization [Online]. Available. <https://www.iso.org/standards.html>.
- StratoSolar [Online]. Available. <http://www.stratosolar.com/>.
- System Optimizer, 2015. Solution for Resource Planning, Capacity Expansion, and Emissions Compliance for Portfolio Optimization. ABB [Online]. Available. https://new.abb.com/docs/librariesprovider139/default-document-library/system-optimizer_br.pdf?sfvrsn=2.
- Trainer, T., 2017. Some problems in storing renewable energy. *Energy Pol.* 110, 386–393.
- Wang, L., Singh, C., 2009. Multicriteria design of hybrid power generation systems based on a modified particle swarm optimization algorithm. *IEEE Trans. Energy Convers.* 24 (1), 163–172.
- Wang, H., Wang, L., Wang, X., Yao, E., 2013. A novel pumped hydro combined with compressed air energy storage system. *Energies* 6 (3), 1554–1567.
- Wang, Y., Huang, L., Shahidehpour, M., Lai, L.L., Yuan, H., Xu, F.Y., 2018. Resilience-constrained hourly unit commitment in electricity grids. *IEEE Trans. Power Syst.* 33, 5604–5614.
- Wang, D., et al., 2019. Two-stage optimal scheduling of air conditioning resources with high photovoltaic penetrations. *J. Clean. Prod.* 241, 118407.
- Wu, Y.-T., Li, Y., Ren, N., Zhi, R.-P., Ma, C.-F., 2018. Experimental study on the thermal stability of a new molten salt with low melting point for thermal energy storage applications. *Sol. Energy Mater. Sol. Cell.* 176, 181–189.
- Xia, S., Chan, K., Luo, X., Bu, S., Ding, Z., Zhou, B., 2018. Optimal sizing of energy storage system and its cost-benefit analysis for power grid planning with intermittent wind generation. *Renew. Energy* 122, 472–486.
- Xie, C., Hong, Y., Ding, Y., Li, Y., Radcliffe, J., 2018. An economic feasibility assessment of decoupled energy storage in the UK: with liquid air energy storage as a case study. *Appl. Energy* 225, 244–257.
- Xu, X., Zhao, J., Xu, Z., Chai, S., Li, J., Yu, Y., 2018. Stochastic optimal TCSC placement in power system considering high wind power penetration. *IET Gener., Transm. Distrib.* 12 (12), 3052–3060.
- Yang, S., Shipworth, M., Huebner, G., 2015. His, hers or both's? The role of male and female's attitudes in explaining their home energy use behaviours. *Energy Build.* 96, 140–148.
- Yang, W., Xiang, Y., Liu, J., Gu, C., 2018. Agent-based modeling for scale evolution of plug-in electric vehicles and charging demand. *IEEE Trans. Power Syst.* 33 (2), 1915–1925.
- Ye, S., Sun, B., 2009. Application of flywheel battery in solar power system. In: *Energy and Environment Technology, 2009. ICEET'09. International Conference on*, vol. 1. IEEE, pp. 533–536.
- Ye, F., Qian, Y., Hu, R.Q., 2018. Smart Grid Communication Infrastructures: Big Data, Cloud Computing, and Security. John Wiley & Sons.
- Yi, B.-W., Xu, J.-H., Fan, Y., 2016. Inter-regional power grid planning up to 2030 in China considering renewable energy development and regional pollutant control: a multi-region bottom-up optimization model. *Appl. Energy* 184, 641–658.
- Zakeri, B., Syri, S., 2015. Electrical energy storage systems: a comparative life cycle cost analysis. *Renew. Sustain. Energy Rev.* 42, 569–596.
- G. Zhang, F. Zhang, K. Meng, X. Zhang, and Z. Dong, "A fixed-point based distributed method for energy flow calculation in multi-energy systems," *IEEE Transactions on Sustainable Energy*, DOI: 10.1109/TSTE.2020.2966737..
- Zhang, Q., McLellan, B.C., Tezuka, T., Ishihara, K.N., 2013. An integrated model for long-term power generation planning toward future smart electricity systems. *Appl. Energy* 112, 1424–1437.
- Zhang, N., Hu, Z., Springer, C., Li, Y., Shen, B., 2016. A bi-level integrated generation-transmission planning model incorporating the impacts of demand response by operation simulation. *Energy Convers. Manag.* 123, 84–94.
- Zhang, T., Chen, L., Zhang, X., Mei, S., Xue, X., Zhou, Y., 2018. Thermodynamic analysis of a novel hybrid liquid air energy storage system based on the utilization of LNG cold energy. *Energy* 155, 641–650.
- Zhao, B.-c., Cheng, M.-s., Liu, C., Dai, Z.-m., 2018. Conceptual design and preliminary performance analysis of a hybrid nuclear-solar power system with molten-salt packed-bed thermal energy storage for on-demand power supply. *Energy Convers. Manag.* 166, 174–186.
- Zheng, J., Sun, X., Jia, L., Zhou, Y., 2020. Electric passenger vehicles sales and carbon dioxide emission reduction potential in China's leading markets. *J. Clean. Prod.* 243, 118607.
- Zhu, J., Zhuang, E., Ivanov, C., Yao, Z., 2011. A data-driven approach to interactive visualization of power systems. *IEEE Trans. Power Syst.* 26 (4), 2539–2546.
- Zidar, M., Georgilakis, P.S., Hatziaziyriou, N.D., Capuder, T., Škrlec, D., 2016. Review of energy storage allocation in power distribution networks: applications, methods and future research. *IET Gener., Transm. Distrib.* 10 (3), 645–652.
- Zimmerman, Ray D., Carlos, E., Murillo-Sanchez, 2016. MATPOWER Optimal Scheduling Tool MOST 1.0: User's Manual. Power Systems Engineering Research Center (PSerc) [Online]. Available. <http://www.pserc.cornell.edu/matpower/MOST-manual.pdf>.
- Zipperer, A., et al., 2013. Electric energy management in the smart home: perspectives on enabling technologies and consumer behavior. *Proc. IEEE* 101 (11), 2397–2408.