

# Economic and financial appraisal of novel large-scale energy storage technologies



Chun Sing Lai <sup>a, b, c</sup>, Giorgio Locatelli <sup>a, \*</sup>

<sup>a</sup> School of Civil Engineering, Faculty of Engineering and Physical Sciences, University of Leeds, Leeds, LS2 9JT, UK

<sup>b</sup> Department of Electrical Engineering, School of Automation, Guangdong University of Technology, Guangzhou, 510006, China

<sup>c</sup> Brunel Institute of Power Systems, Department of Electronic and Electrical Engineering, Brunel University London, London, UB8 3PH, UK

## ARTICLE INFO

### Article history:

Received 14 November 2019

Received in revised form

4 July 2020

Accepted 28 September 2020

Available online 1 October 2020

### Keywords:

Generation integrated energy storage

Wind power

Financial model

Pumped-heat energy storage

## ABSTRACT

Energy storage can store surplus electricity generation and provide power system flexibility. A Generation Integrated Energy Storage system (GIES) is a class of energy storage that stores energy at some point along with the transformation between the primary energy form and electricity. The investigation of the economic and financial merits of novel energy storage systems and GIES is relevant as these technologies are in their infancy, and there are multiple technological, economic, and financial uncertainties and opportunities. This paper presents and applies a state-of-the-art model to compare the economics and financial merits for GIES (with pumped-heat energy storage) and non-GIES (with a Lithium-ion battery) systems coupled with wind generation in the United Kingdom. The deterministic, risk, and sensitivity analyses show that, for GIES's economics, the key driver is the generator capital cost; for non-GIES, the energy storage capital cost is the most important factor. A Monte Carlo analysis shows that the levelized cost of electricity values for GIES and non-GIES are 0.05 £/kWh - 0.12 £/kWh and 0.07 £/kWh - 0.11 £/kWh, respectively, for a 100 MW wind power generator and 100 MWh energy storage. The internal rate of return values for GIES and non-GIES are uncertain and range between 2%–22% and 5%–14%, respectively.

© 2020 The Authors. Published by Elsevier Ltd. This is an open access article under the CC BY license (<http://creativecommons.org/licenses/by/4.0/>).

## 1. Introduction

It is possible to divide energy storage technologies into two classes: Generation Integrated Energy Storage system (GIES) and non-GIES.

Non-GIES is a grid-scale energy storage comprised of electrochemical energy storage including batteries. Batteries, such as Lithium-ion, have high round-trip efficiency and power along with energy density. However, using Lithium-ion batteries also has a relevant environmental impact due to the natural resources required for assembly and the pollution it omits after disposal, i.e. toxic chemicals such as Cobalt [1]. Lithium-ion batteries also have a relatively short-life due to cell degradation [2]. There is a need to assess the types of energy storage for low-carbon power generation.

GIES is a novel and distinctive class of integrated energy

systems, composed of a generator and an energy storage system. GIES “stores energy at some point along with the transformation between the primary energy form and electricity” [3, p. 544], and the objective is to make storing several MWh economically viable [3]. GIES technologies are non-electrochemical and include thermal energy storage and compressed air energy storage. The idea is converting the primary energy into an energy form that is easier to store than electricity, e.g. wind with a pumped-heat energy storage (Wind-TP) system [4,5].

There are several papers on the economic appraisal for non-GIES, e.g. Ref. [6–8], but only a few deal with GIES [9,10]. Moreover, there is a gap in the literature about the financial analysis for all energy storage technologies, and there is no explicit economic and financial comparison between GIES and non-GIES. Current studies are relatively oversimplified and do not account for key relevant indicators, e.g. the length of debt and sources of financing. It is also unclear which parameters (i.e. economic, financial, and technical) are driving the economic and financial performance of GIES and non-GIES.

This paper addresses this gap in knowledge by presenting a Discounted Cash Flow (DCF) model to examine the Levelized Cost of

\* Corresponding author.

E-mail addresses: [chunsing.lai@brunel.ac.uk](mailto:chunsing.lai@brunel.ac.uk) (C.S. Lai), [g.locatelli@leeds.ac.uk](mailto:g.locatelli@leeds.ac.uk) (G. Locatelli).

**List of abbreviations**

CfD	Contract for Difference
DCF	Discounted Cash Flow
GIES	Generation Integrated Energy Storage
IRR	Internal Rate of Return
LCOE	Levelized Cost of Electricity
NPV	Net Present Value
O&M	Operation and Maintenance
PDF	Probability Density Function
STOR	Short Term Operating Reserve
WACC	Weighted Average Cost of Capital
Wind-TP	Wind with pumped-heat energy storage

Electricity (LCOE), Net Present Value (NPV), and Internal Rate of Return (IRR) for GIES and non-GIES. The DCF model includes the most relevant technical, financial, and economic inputs, and it can be applied to all energy storage technologies. Deterministic, risk, and sensitivity analyses have been conducted to compare the financial and economic merits.

The case studies assessed in this work are GIES (an integrated wind power generator with a compressor and pumped-heat energy storage) and non-GIES (a permanent magnet synchronous machine wind power generator with a Lithium-ion battery). The novelties of this work include a model and an application, as follows:

- A state-of-the-art and comprehensive DCF model tailored for the economic and financial appraisal of energy storage technologies
- The derivation of the financial merit for both non-GIES and

$$\eta_s = \frac{\text{electrical energy output from the system if all energy passed through storage}}{\text{electrical energy output from the system if no energy passed through storage}} \quad (1)$$

$$\eta_T = \frac{\text{electrical energy output from the system if no energy passed through storage}}{\text{total primary energy input to the system}} \quad (2)$$

novel GIES

- The first-of-a-kind comparison between GIES and non-GIES from the economic and financial standpoint

The research questions are:

- How does a non-GIES compare to a GIES from an economic and financial perspective?
- What inputs mostly affect the economic and financial performance of GIES and non-GIES?
- What uncertainties mostly affect the economic and financial performance of GIES and non-GIES?

The rest of the paper is structured as follows: Sections 2 presents a critical literature review for GIES and non-GIES. The state-of-the-art DCF model is given in Section 3. Sections 4 presents the model and inputs for the UK case study. Section 5 presents the deterministic, risk, and sensitivity analyses on the technical, economic, and financial inputs. Section 6 concludes the paper and provides a research agenda.

## 2. Literature review of GIES and non-GIES

### 2.1. GIES systems

Garvey et al. [3] introduced the terminology and concept of “GIES”. GIES aims to minimize the energy storage cost and maximize the exergy efficiency for electricity utilization and generation. Examples of this class of technology are:

- Thermal energy storage [9,11–13] with concentrating solar power where thermic oils and molten salts are mature heat transfer fluids for thermal energy storage. Thermal energy storage consists of sensible heat energy storage, latent heat energy storage, and thermochemical energy storage [14]. Thermochemical energy storage has a lower heat loss, volume requirement, and charging temperature compared to sensible heat energy storage and latent heat energy storage [13,15].
- Pumped-heat/thermal energy storage [16–18] with wind power. Initially introduced in the late 1970s, pumped-heat energy storage consists of two thermal energy storage vessels and a reversible heat engine/heat pump. Davenne et al. [19] studied the exergy losses of an integrated wind power generator and pumped-heat energy storage system known as “Wind-TP” with a packed bed as the cold store and a liquid thermocline [5]. Wind-TP is a power transmission system for wind turbines that allows for a great amount of energy to be stored [5].

There are three key parameters associated with GIES and non-GIES [3]: the storage (i.e. from primary energy form to storage energy form) efficiency ( $\eta_s$ ), transmission (i.e. from primary energy form to electricity) efficiency ( $\eta_T$ ), and the throughput (to examine the overall GIES and non-GIES efficiency) efficiency ( $\eta_X$ ). These are defined as the following [3]:

$$\eta_X = \frac{\text{total electricity output from the system}}{\text{total primary energy input to the system}} \quad (3)$$

### 2.2. Non-GIES

Non-GIES technologies are mainly electrochemical. The energy in its primary form (e.g. heat) is immediately transformed to electricity for storage. Non-GIES are increasingly popular with 3 GW installed worldwide as of 2018 [20]. Some of the largest grid-scale energy storage projects for renewables with batteries include the Alamos Energy Storage Array and the Kingfisher Project (Stage 2), having a rated capacity at 100 MW and 400 MWh, respectively [21]. For grid-scale energy storage, the two most mature technologies are the [21,22]:

- Lithium-ion battery: This is the dominant form of electrochemical energy storage. It has a very high round-trip efficiency

(95%), low self-discharge rate, and high energy density. However, energy storage degradation is an issue that has economic consequences [23,24].

- Redox-flow battery: The energy and power ratings for the redox-flow battery can be independently scaled, depending on the size of the electrolyte tanks and the number of stacks of electrochemical cells, respectively. The issue is the possible cross-contamination of the two electrolytes if the positive and negative electrolytes are different (e.g. for a zinc-iron redox-flow battery); consequently, this degrades the energy storage performance [25,26].

### 2.3. Economic and financial models for GIES and non-GIES

Table 1 presents and cross-compares the literature on relevant techno-economic or financial studies. Table 1 also benchmarks the literature against the model presented in this paper. There are more references about non-GIES than GIES due to the popularity of batteries in grid energy storage. Table 1 shows that there are currently no studies comparing GIES and non-GIES.

### 3. Cash flow modelling of GIES and non-GIES

A DCF analysis is a standard approach to assess the economic

**Table 1**  
Comparison of recent financing and techno-economic studies for GIES and non-GIES.

Class of system	GIES and non-GIES	GIES	Non-GIES						
<b>Ref.</b>	This work	Casati et al., 2015 [9]	Chen et al., 2018 [10]	Tohidi and Gibescu, 2018 [27]	Mejía-Giraldo et al., 2019 [28]	Xia et al., 2018 [6]	Affonso and Kezunovic, 2018 [7]	Cucchiella et al., 2017 [8]	Jones et al., 2017 [29]
<b>Country</b>	UK	USA and Spain	China	Netherlands	Colombia	Unspecified	USA	Italy	UK
<b>Generation</b>	Wind	Concentrating solar power	Concentrating solar power	Photovoltaic	Photovoltaic	Wind	Photovoltaic	Photovoltaic	Photovoltaic
<b>Energy storage</b>	Lithium-ion and pumped-heat energy storage	Thermal (molten salt)	Thermal (molten salt)	Hydrogen-bromine flow battery	Lead-acid	Lead-acid, superconducting magnet, zinc-bromine, and sodium-sulphur	Lead-acid	Lead-acid	Lithium-ion
<b>Research context</b>	This paper presents and applies a state-of-the-art model to compare the economics and financial merits for GIES (with pumped-heat storage) and non-GIES (with a Lithium-ion battery) systems coupled with wind generation in the UK.	Comparing various optimal control strategies with financial analysis to maximize the system's revenue.	Presenting a thermo-economic model for a 50 MW solar tower power system with molten salt energy storage. Examining the investment cost and optimal sizing.	Presenting a stochastic optimisation model to examine revenue streams for flow batteries with Photovoltaic.	Proposing a method for battery storage sizing to provide a primary frequency regulation service of Photovoltaic.	Using a stochastic model to size the energy storage for power grid planning with wind generation.	Proposing a smart charging technique to avoid transformer overloading and reduce electricity consumption costs. The system consists of a charging station, integrated with Photovoltaic and battery energy storage.	Conducting a discounted cash flow analysis to evaluate the financial feasibility of photovoltaic-integrated lead-acid battery systems.	Combining a life cycle assessment approach and DCF analysis to assess the carbon dioxide and financial impact, with adding a battery to a Photovoltaic system.
<b>Revenues considered</b>	Contract for Difference (CfD), Short Term Operating Reserve (STOR), Fast Reserve, and wholesale market	Power purchase agreement bid price	None	Day-ahead market and imbalance market	None	None	Electricity price	Electricity purchase price	Feed-in tariff
<b>Financial and economic indicators examined</b>	NPV, IRR, debt duration, LCOE, and LCOS	NPV and LCOE	LCOE	Expected profit	Investment cost	Present value	NPV, payback period, IRR	NPV	NPV
<b>Key findings</b>	Wind power without energy storage is the best system (considering profitability). GIES and non-GIES are economical and financial comparable (see section 5).	Potential gains up to 10% in terms of yearly revenue are estimated, in case improved control strategies are adopted.	The financial parameters have little effect on the heliostat cost with the optimal design with direct normal irradiance.	It is economic to use energy storage for energy arbitrage and self-consumption, for photovoltaic and load system	Battery replacements and battery lifetime are the most crucial factors to define the battery size.	The energy storage charging/discharging efficiency, amortized daily capital cost, and lifetime are crucial to affect the system cost-benefits.	The method given can prolong distribution transformer life and apparent financial benefits.	The profitability of a photovoltaic-integrated battery system is affected by the energy storage energy self-consumption and the presence of subsidies.	The battery cost needs to drop significantly to contribute positively to the financial performance of photovoltaic systems in the current UK market.

and financial merits of an investment [30]. A DCF analysis establishes the present value of expected future cash flows with a discount rate. The total present value of all the DCFs (cost and revenues) is called NPV. The investment needs a positive NPV to sufficiently remunerate debt and equity holders.

This paper examines three technologies (details can be found in Appendix A):

- A GIES named “Wind-TP” consisting of a wind compressor and pumped energy storage
- A non-GIES consisting of a permanent magnet synchronous machine wind power generator and a battery
- A “Wind-only system” with a permanent magnet synchronous machine wind power generator. This is the non-GIES without energy storage; it is included in this study for the purpose of comparison

Adopted from Ref. [31], Fig. 1 shows the key relationships between stakeholders within the financial model. For large projects, the typical financing resources include debt and equity. Sainati et al. [32] provided an overview of how organizations engage in the financing of large energy projects. Earnings before interest and taxes measure the profit, including all incomes and expenses, without income tax expenses and interest expenses. Equity holders expect a return from the dividend which is variable and depends on the business performance.

- LCOE: This is the price of the electricity necessary to cover all the life cycle cost [24,33,34]. The classical formulation of LCOE is [34]:

$$LCOE \left[ \frac{\text{£}}{\text{MWh}} \right] = \frac{\sum_{n=0}^N \frac{C_{capn} + C_{O\&Mn}}{(1+WACC)^n}}{\sum_{n=0}^N \frac{E_n}{(1+WACC)^n}} \quad (4)$$

Where  $C_{cap}$  is the capital cost [£],  $C_{O\&M}$  is the operational and maintenance cost [£],  $E$  is the system energy output [MWh], and  $N$  is the system lifetime [years]. The LCOE is computed with the earnings before interest and taxes cash flow. The cash flow for the LCOE is discounted at the discount rate or the Weighted Average Cost of Capital (WACC) [35]. The WACC calculation is written in the following form [31]:

$$WACC = K_E \cdot \theta_{CAPEX} + K_D \cdot (1 - \theta_{CAPEX}) \cdot (1 - \theta_{TAX}) \quad (5)$$

$K_E$  is the cost of equity [%] and  $K_D$  is the cost of debt [%]. Both are proportional to the investment risk.  $\theta_{CAPEX}$  is the equity share on CAPEX [%] and  $\theta_{TAX}$  is the effective tax rate [%]. The LCOE is used by policymakers and engineers in comparing technologies and estimating the electricity sales price for the technology to break-even.

There are two different relevant NPVs in the financial analysis and investment appraisal:

- NPV to the firm: This is the sum of the unlevered cash flows

discounted with the WACC or the “free cash flow to the firm”. Debt holders have the expected remuneration if the NPV is greater than zero. This NPV accounts for the tax rate and earnings before interest. NPV to the firm is based on the cash flows before deducting the financial obligation (e.g. interest and debt payments).

- NPV to the equity: This is the sum of the levered cash flows. Discounting the “free cash flow to the equity” at the cost of equity gives the NPV to the equity. It is the NPV from the perspective of equity holders (i.e. the “owners of the energy storage”) after the debt has been repaid to the debt holders. The equity holders receive a payment equal to the cost of equity if the NPV is zero.

Fig. 2 presents the financial and economic modelling process. The inputs can be categorized into three major categories: technical, economic, and financial. The cash flow model used in this paper is built following the work in Ref. [31]. Ref. [31] is an open-access article and provides all the details of the cash flow model while in this paper the key elements are presented.

#### 4. The UK case study

Due to data availability and relevance, this work uses the UK scenario to compare GIES and non-GIES. Wind power alone accounts for 21.2% of the UK’s total electricity generation in 2019, and it is the most relevant non-dispatchable source of power [36]. Therefore, this paper will focus on storing energy produced by a wind farm.

##### 4.1. Costs

For the energy storage and power generator, capital costs are the upfront cost consisting of both “hard costs” (e.g. pumped-storage hydroelectricity systems are hydro turbines, electric motors, and generators) and “soft costs” (e.g. licensing fees and the engineering, procurement, and construction costs) [37,38]. O&M costs occur during the system life cycle and include labor, repair, regular servicing, and electricity purchasing (energy storage charging cost) [37]. Table 2 presents the overnight and operating costs for energy storage technologies. There is a large cost variation for energy storage due to various factors, including geographical location and manufacturing. For example, the location of pumped-storage hydroelectricity and compressed air energy storage constitutes a large percentage of the overnight cost; this cost will increase with additional groundwork.

The Balance of System is the auxiliary equipment (e.g. power converters) for an energy system [38,39]. Table 3 presents the breakdown of the capital cost for four energy storage technologies available from Ref. [38]. For a Vanadium redox flow battery, there is a wider variation in the percentage of capital cost due to the flexibility of the system configuration, especially on changing the energy and power capacities. For compressed air energy storage and pumped-storage hydroelectricity, the owner’s cost is an indirect capital cost that can be accounted for insurance, legal fees, and community support [40].

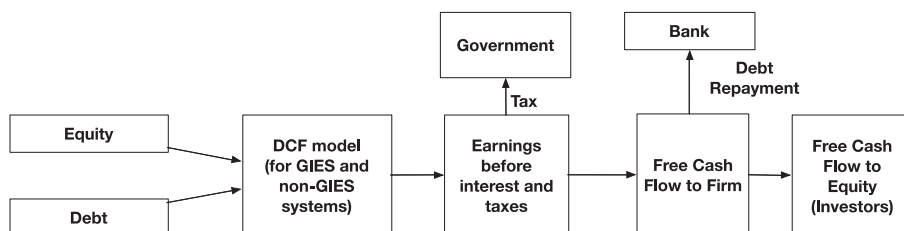

Fig. 1. Schematic of the financial model for GIES and non-GIES studies. This DCF model considers three outputs.

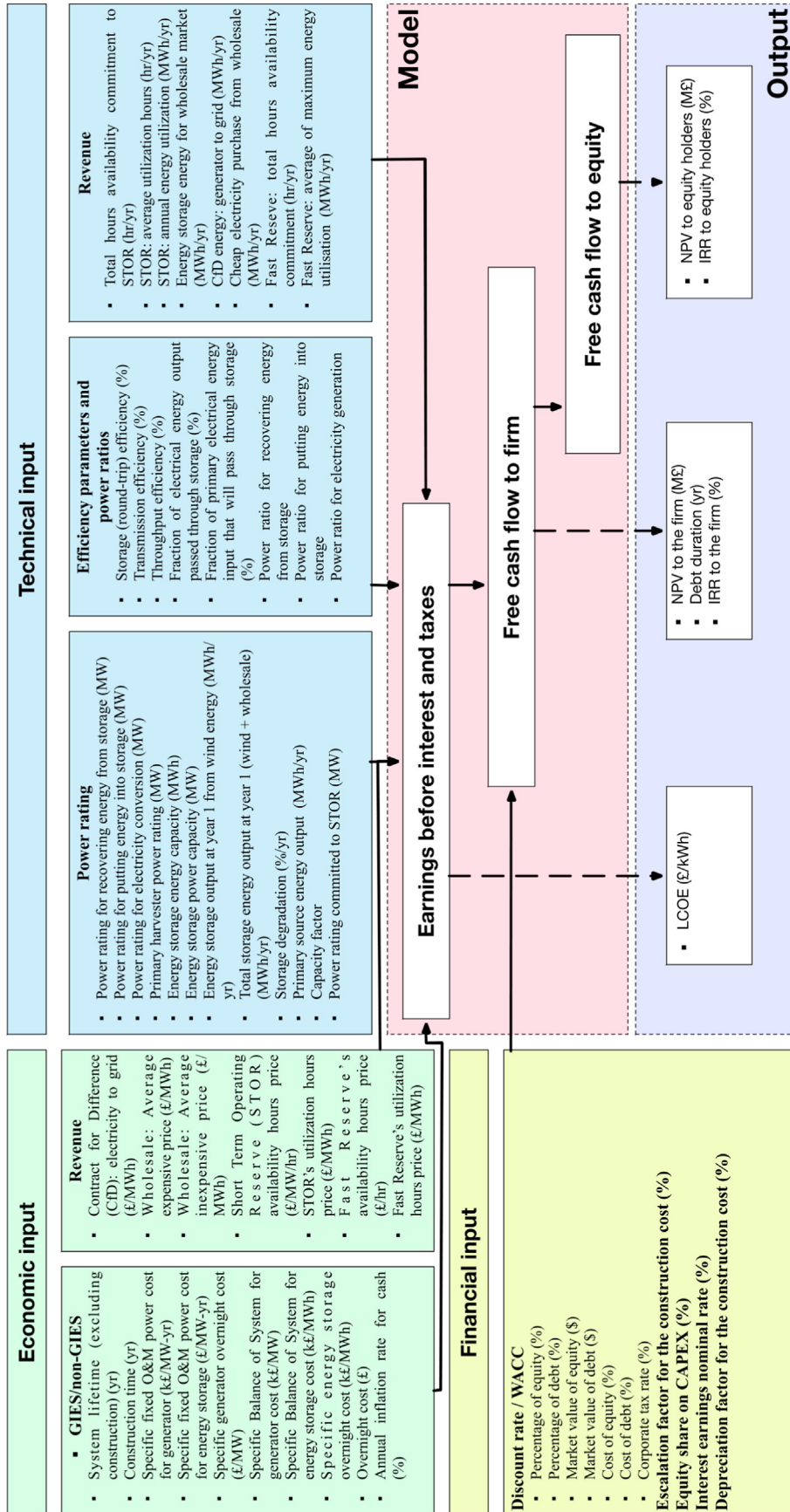

Fig. 2. Technical, financial, and economic inputs for GIES and non-GIES financial assessments.

**Table 2**  
Overnight and operating costs for five energy storage technologies.

	Type	Energy storage	Overnight cost (£/kWh)	Fixed O&M cost (£/kW-yr)
<b>GIES</b>	Mechanical	Pumped-storage hydroelectricity	3.8–38.2 [22,43–46]	2.3–7.8 [44–46]
		Compressed air energy storage	5.5–31.8 [22,43–46]	1.6–10.6 [44,46]
		Flywheel	339.5–733 [22,43,45,46]	3.7–5.1 [45,46]
<b>Non-GIES</b>	Heat Electrochemical	Pumped-thermal energy storage	11–17.8 [18,47]	0.0022 [18]
		Lithium-ion	130–300 [22,43,45,46,48]	1.7–7.8 [44,46]
		Vanadium redox flow battery	113–650 [22,44–46]	2.6–12.6 [22,44–46]

**Table 3**  
Generic cost breakdown of four energy storage technologies [38].

Type	Energy storage	Capital cost (%)
<b>GIES (mechanical)</b>	Pumped-storage hydroelectricity	Powerhouse: 37; upper reservoir: 19; tunnels: 6; powerhouse excavation: 4; engineering, procurement, and construction and management: 17; and owner's costs: 17.
	Compressed air energy storage	Cavern: 40; turbine: 30; compressor: 14; Balance of System: 7; engineering, procurement, and construction and management: 3; and owner's costs: 6.
<b>Non-GIES (electrochemical)</b>	Lithium-ion	Materials costs (e.g. anode, cathode, separator, and electrolyte): 30–60; labor: 5–20; and overhead: 5–30.
	Vanadium redox flow battery	Peripherals (fluid regulation: 4, assembling: 9, control engineering: 9, and power electronics: 9); electrolyte and tanks: 35; and stack: 34.

For a wind power generator, the construction cost is dominated by the upfront capital cost for the wind turbine, and 1164 k€/MW is a reference value [41]. A GIES's wind turbine has a capital cost that is roughly 10% higher than a non-GIES [3]. The specific Balance of System cost for wind power generator is between 16% and 36% of power generator capital cost [42]. The O&M cost for the wind power generator is between 2%/yr and 5%/yr of the capital cost [42]. Since GIES systems using pumped-heat energy storage are still in the study and feasibility stage, it is difficult to quantify "Balance of System" costs. A reasonable value is 10%–15% of the specific energy storage capital cost [38].

#### 4.2. Revenue sources

Similar to other countries, there are four main revenue sources in the UK:

**Contract for difference (CfD):** CfD is a low-carbon electricity generation investment incentive, providing predictability and stability to revenue streams [49]. CfD is a contract between a low-carbon electricity generator and the Low Carbon Contracts Company, a government-owned company [50]. The contract usually lasts for 15 years [49]. CfDs allow generators to receive a pre-agreed, fixed price (i.e. "strike price") for the produced electricity for the contract duration [49,51]. The scheme's costs are funded by a statutory levy on all licensed electricity suppliers, which is passed on to consumers [52]. The average strike price for 15 onshore wind farms provided by the CfD register was at 92.55 £/MWh in May 2019 [53].

**Wholesale market/spot price:** The wholesale price increases with the demand for electricity. Nord Pool AS presents the hourly wholesale market price [54]. Table 7 shows the market prices.

**Short Term Operating Reserve (STOR):** STOR is a contracted balancing service. The provider provides a contracted level of power when instructed by the National Grid Electricity System Operator to meet energy reserve requirements [55]. The STOR provider must offer a minimum of 3 MW of generation or steady demand reduction (this can be a combination of more than one source of power) for at least 2 h [30,55]. Table 5 shows the STOR's average utilization hours in the northern region [56] and the STOR's total hours availability commitment [30,57]. Tables 5 and 7 summarize the key values for STOR.

**Fast Reserve:** Fast Reserve delivers rapid active power by

increasing the generation or reducing the demand, as instructed by an electronic dispatch instruction from the National Grid Electricity System Operator [58], by participating in controlling frequency changes. Fast Reserve requires all units to be able to start service delivery within 2 min following the instruction, at a rate of 25 MW/min or greater, and provide a minimum of 50 MW. The Fast Reserve provider needs to deliver continuously for a minimum of 15 min [58]. Based on eight tendering cases from the post-assessment tender report [59], Tables 5 and 7 present the key values for Fast Reserve.

Fig. 3 presents the energy flow of a GIES, non-GIES, and wind-only systems concerning the revenue sources. Due to the conversion between heat and electricity, the feasibility of pumped-heat energy storage for energy arbitrage will be examined in Section 5.1. The key hypothesis is:

1. The power and energy ratings for the wind power generator (multiple wind turbines) and energy storage are 100 MW and 100 MWh, respectively
2. The "wind-only system" sells all the energy to the grid at the CfD price
3. The wind system with energy storage can either sell to the grid at the CfD price or store the energy. If there is available storage space, then the energy is stored first. If there is no space, then the energy is sold through the CfD
4. The energy in storage is sold to the wholesale market or used for grid services

Regarding the wholesale market:

a. If the wind power generator cannot provide all the energy for the energy storage and the energy storage's "empty capacity" is available, then the energy storage will buy electricity from the grid at an average low price (i.e. when there is a low demand for electricity).

Regarding the grid services:

- a. The energy storage can serve both the STOR and Fast Reserve
- b. The STOR demands and Fast Reserve demands are independent
- c. Energy storage always has enough energy to satisfy at least the demands from STOR and Fast Reserve

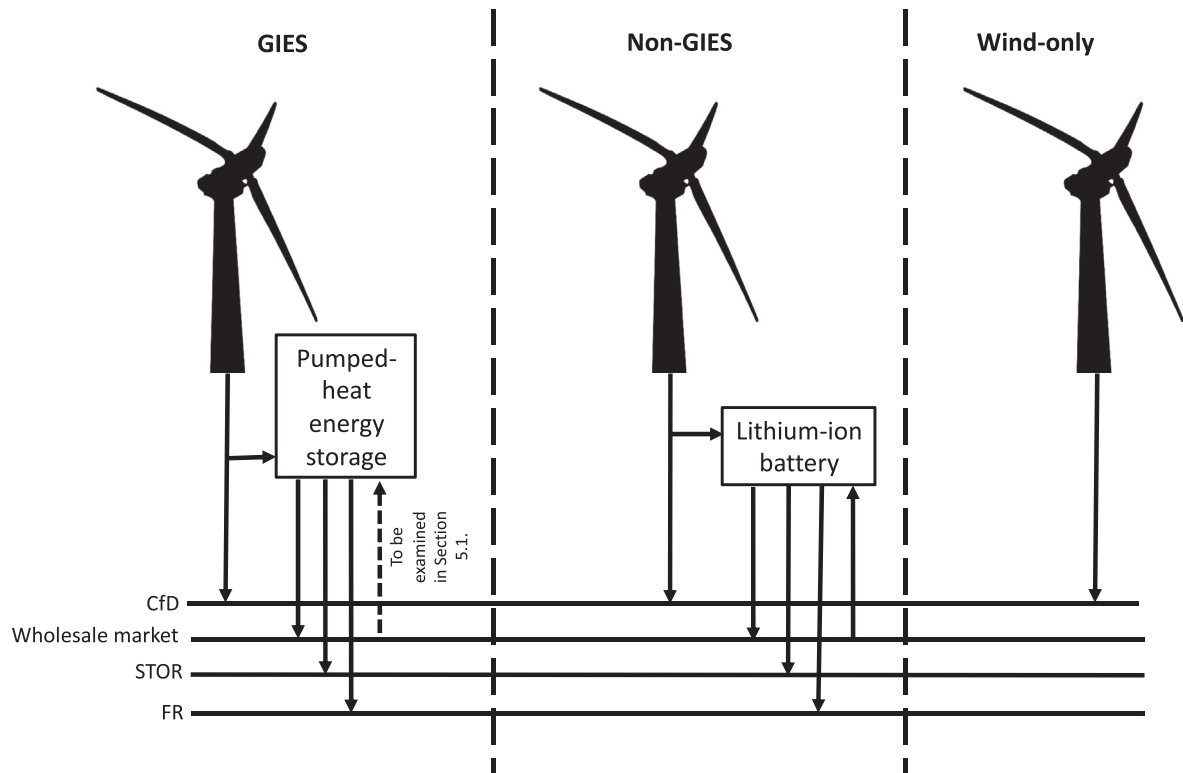

Fig. 3. Revenue sources with the generation and energy storage system. The arrows represent the energy flow.

Table 4  
Project time, power rating, and efficiency parameters of GIES and non-GIES (technical specification).

Category	Index	Input	GIES (thermal based)			Non-GIES (chemical based)		
			Min.	Most likely	Max.	Min.	Most likely	Max.
<b>Project time</b>	A1	Construction time [yr]	2	3	4	2	3	4
	A2	System life (excluding construction) [yr]	22	25 [64]	27	10	12 [21,45]	15
<b>Power rating</b>	B1	Power rating for recovering energy from storage ( $P_{\eta_{B4}}$ ) [MW]	$P_{Har} \cdot \eta_{B4}$					
	B2	Power rating for putting energy into storage ( $P_{\eta_{B3}}$ ) [MW]	$P_{Har} \cdot \eta_{B3}$					
	B3	Power rating for electricity conversion ( $P_{\eta_{B2}}$ ) [MW]	$P_{Har} \cdot \eta_{B2}$					
	B4	Primary harvester power rating ( $P_{Har}$ ) [MW]	100					
	B5	Energy storage energy capacity ( $E_{energystorage}$ ) [MWh]	100					
	B6	Energy storage power capacity ( $P_{energystorage}$ ) [MW]	50					
	B7	Energy storage energy output at year 1 from wind energy ( $E_{energystorage-Har}$ ) [MWh/yr]	$E_{Har} \cdot \eta_X \cdot \beta_{SO}$					
	B8	Total energy storage energy output at year 1 (wind + wholesale) ( $E_{energystorage-Output}$ ) [MWh/yr]	$E_{STOR-Util} + E_{Sell-Wholesale} + E_{CFD} + E_{FastReserve-Util}$					
	B9	Energy storage degradation ( $\theta$ )[%/yr]	Negligible [64]			2 [34]		
	B10	Primary source energy output ( $E_{Har}$ ) [MWh/yr]	$P_{Har} \cdot CF \cdot 365 \cdot 24$					
	B11	Capacity factor (CF) [%]	30 [3]					
	<b>Efficiency parameters</b>	B12	Power rating committed to STOR ( $P_{STOR}$ ) [MW]	20 [56]				
C1		Storage (round-trip) efficiency ( $\eta_S$ ) [%]	84.1	88.5 [3,5,18]	89	90.3	95.0 [65]	99.8
C2		Transmission efficiency ( $\eta_T$ ) [%]	82.2	86.5 [3,5]	87	96.3	98.3 [66]	100.0
C3		Throughput efficiency ( $\eta_X$ ) [%]	$\frac{\eta_T \cdot \eta_S}{\eta_S + (1 - \eta_S) \cdot \beta_{SO}}$ [3]					

### 4.3. Modelling inputs

Tables 4 and 5 present the technical specifications. The input values for the wind-only system are the same as the non-GIES with energy storage parameters set to zero. A GIES system must set three different power ratios: “power rating for putting energy into storage”, “power rating for recovering energy from storage”, and the “electricity generation power rating” [3]. The power input from the primary energy source is taken as the reference rating acting as the

denominator for each of the three ratios. The operating lifetime for the technologies is the same for a meaningful comparison. Since the life of batteries is about half of a wind turbine, one replacement is included for a non-GIES, and this is reflected in the overnight cost [22,45].

The Department of Energy Global Energy Storage Database provides the construction time for energy storage projects [60]. The average construction time for grid-scale energy storage with a wind power generator is four years.

**Table 5**  
Power ratios and revenue of GIES and non-GIES (technical specification).

Category	Index	Input	GIES (thermal based)			Non-GIES (chemical based)		
			Min.	Most likely	Max.	Min.	Most likely	Max.
<b>Power ratios</b>	D1	Fraction of electrical energy output from generator passed through energy storage ( $\beta_{SO}$ ) [%]	17			15		
	D2	Fraction of primary electrical energy input that will pass through energy storage ( $\beta_{SI}$ ) [%]	$\frac{\beta_{SO}}{\eta_S + (\beta_{SO} \cdot (1 - \eta_S))}$ [3]					
	D3	Power ratio for recovering energy from storage ( $\eta_{B4}$ )	1 [3]					
	D4	Power ratio for putting energy into storage ( $\eta_{B3}$ )	1 [3]					
	D5	Power ratio for electricity generation ( $\eta_{B2}$ )	CF [3]					
<b>Revenue</b>	E1	Total hours availability commitment to STOR ( $H_{STOR-Avail}$ ) [Hr/yr]	3867 [30,57]					
	E2	STOR: average utilization hours ( $H_{STOR-Util}$ ) [Hr/yr]	39.42 [56]					
	E3	STOR: annual energy utilization ( $E_{STOR-Util}$ ) [MWh/yr]	$H_{STOR-Util} \cdot P_{STOR}$					
	E4	Energy storage energy for wholesale market ( $E_{Sell-Wholesale}$ ) [MWh/yr]	$\eta_S \cdot (E_{energystorage-Har} + E_{Buy-Wholesale}) - E_{STOR-Util} - E_{FastReserve-Util}$					
	E5	CfD energy: generator to grid ( $E_{Cfd}$ ) [MWh/yr]	$(E_{Har} - E_{energystorage-Har}) \eta_T$					
	E6	Cheap electricity purchase from wholesale ( $E_{Buy-Wholesale}$ ) [MWh/yr]	$\frac{E_{energystorage} \cdot 365 - E_{energystorage-Har}}{\eta_S}$					
	E7	Fast Reserve: total hours availability commitment ( $H_{FastReserve-Avail}$ ) [Hr/yr] [59]	448	2957.5	5040	448	2957.5	5040
	E8	Fast Reserve: maximum energy utilization ( $E_{FastReserve-Util}$ ) [MWh/yr] [59]	0	422.5	1200	0	422.5	1200

**Table 6**  
Specific economic and financing specifications of GIES and non-GIES.

Category	Index	Input	GIES (thermal based)			Non-GIES (chemical based)		
			Min.	Most likely	Max.	Min.	Most likely	Max.
<b>Economics</b>	F1	Specific fixed O&M power cost for generator ( $C_{O\&M-Gen}$ ) [k€/MW-yr] <sup>a</sup>	30	45	74	53	59	67
	F2	Specific fixed O&M power cost for energy storage ( $C_{O\&M-energystorage}$ ) [€/MW-yr] <sup>b</sup>	$1.43 \cdot 10^{-6}$	$2.2 \cdot 10^{-6}$	$3.63 \cdot 10^{-6}$	1700	4750	7800
	F3	Specific generator overnight cost ( $C_{Har}$ ) [€/MW] <sup>c</sup>	832	1280	2112	1047	1164	1338
	F4	Specific Balance of System for generator cost ( $C_{BOP-Har}$ ) [k€/MW] <sup>d</sup>	249	384	633	296	349	419
	F5	Specific Balance of System for energy storage cost ( $C_{BOP-energystorage}$ ) [k€/MWh] <sup>e</sup>	0.83	2.80	4.77	117	139	166
	F6	Specific energy storage overnight cost ( $C_{energystorage}$ ) [k€/MWh] <sup>f</sup>	5.5	18.65	31.8	130	215	300
	F7	Overnight cost ( $C_{Overnight}$ ) [k€]	$E_{energystorage} \cdot (C_{BOP-energystorage} + C_{energystorage}) + P_{Har} \cdot C_{Har} + (\max(P_{\eta_{B3}}, P_{\eta_{B4}}) + P_{\eta_{B2}}) \cdot C_{BOP-Har}$ GIES: 181000; non-GIES: 213000; wind-only 127000					
<b>Financing</b>	F8	Annual inflation rate for cash (O&M and revenue) from 1998 to 2018 [%] [67]	2.8					
	G1	Cost of debt ( $K_D$ ) [%] [68] <sup>g</sup>	4	5	6	3	4	5
	G2	Cost of equity ( $K_E$ ) [%] [68] <sup>g</sup>	5	6	8	4	6	7
	G3	WACC [%]	$K_E \cdot \theta_{CAPEX} + K_D \cdot (1 - \theta_{CAPEX}) \cdot (1 - \theta_{Tax})$					
	G4	Escalation factor for construction costs [%]	0					
	G5	Depreciation factor for capital cost [%]	5					
	G6	Equity share on CAPEX ( $\theta_{CAPEX}$ ) [%]	30					
	G7	Effective tax rate ( $\theta_{Tax}$ ) [%] [69]	11					
G8	Interest earnings nominal rate [%]	0.7						

<sup>a</sup> based on 3.5% and 5% of the specific generator overnight cost for GIES and non-GIES, respectively, as described in Section 4.1;

<sup>b</sup> based on Table 1;

<sup>c</sup> based on Section 4.1;

<sup>d</sup> based on 30% of the specific generator overnight cost as described in Section 4.1;

<sup>e</sup> based on 15% and 35% of the specific energy storage overnight cost for GIES and non-GIES, respectively, as described in Section 4.1;

<sup>f</sup> based on Table 1;

<sup>g</sup> The uncertainty and the resultant investment risk for Wind-TP are higher than the well-established wind-battery systems. The extra-risk is reflected in adjusting the cost of debt and the cost of equity.



**Table 7**  
Economic specifications for revenue sources.

Service	Index	Input	Min.	Most likely	Max.
CfD [53]	H1	Strike price [€/MWh]	89.12	92.55	93.92
Wholesale market [54]	H2	Average daily expensive price [€/MWh]	62.00	71.77	83.15
	H3	Average daily inexpensive price [€/MWh]	20.00	35.73	40.91
STOR [56]	H4	Average availability hours price [€/MW/hr]	4.25		
	H5	Average utilization hours price [€/MWh]	150.57		
Fast Reserve [59]	H6	Availability hours price [€/hr]	160.00	277.75	504.00
	H7	Utilization hours price [€/MWh]	84.00	97.875	106.00
Environment externalities	H8	Cost of carbon emission [€/tCO <sub>2</sub> ]	18 [70]		
	H9	Carbon emission intensity for natural gas generator [kg/MWh]	180 [71]		

For inputs with the known upper and lower bounds, the average is determined from the two values. PERT distributions are used for the inputs with three parameters as they are the most realistic [30]. A log-normal distribution is used for the STOR prices with a 20% variance [61].

The cost of debt ( $K_D$ ) and the cost of equity ( $K_E$ ) depend on many factors, including the technology maturity. Since GIES is in the research and development stage,  $K_D$  and  $K_E$  are higher than the non-GIES, reflecting a higher investment risk [62].

The cost estimate guidelines from the Association for the Advancement of Cost Engineering are applied for cost inputs in Table 6 [63]. Because the GIES is in the “study and feasibility stage” and non-GIES are in “bid/tender stage”, Class 2 and Class 4 estimates are used for GIES and non-GIES, respectively. Table 7 presents the economic specifications for the revenue sources.

## 5. Results and discussion

This section compares the economic and financial merits for three systems with deterministic, risk, and sensitivity analyses. The deterministic analysis examines the finance and economics for the three systems according to the base value (i.e. the most likely). The risk analysis considers the probability distribution of the inputs, and a Monte Carlo analysis is conducted to examine the effect of the uncertainty associated with the economic and financial indicators. The sensitivity analysis examines the individual model inputs and their contribution towards the cost and revenue.

### 5.1. The merit of using GIES in storing grid electricity

Considering the energy conversion process and the constraints from the Carnot efficiency, the conversion from electricity to thermal and to electricity again will give higher energy losses than

electricity to electricity conversion alone. To trigger the need for the energy storage to import grid electricity,  $\beta_{SO}$  is set to 5% as such that the energy storage is not charged to its full capacity from the generator. Table 8 presents the economic and financial results for the two storage efficiencies of pumped-heat energy storage under the different hypothesis of GIES efficiency.

Although the amount of energy import relative to the GIES total energy output is nearly twice when the storage efficiency is at 50% compared to 88%, the LCOE for both cases are similar. Considering the four scenarios in Table 8, the LCOE is within 0.008 €/kWh (i.e. 0.078–0.070) and it is not a great variation. This is due to the variable O&M cost (cost for importing grid’s electricity), which is marginal when compared to the fixed O&M cost and capital expenditure. Many financial results are similar under the two storage efficiencies, such as the debt duration and IRR to the equity holders. Similar to the LCOE discussion, the variable O&M cost is small compared to the revenue received. The NPV to the firm is sounding for the investment considering that the overnight cost is at 181 M€. The storage efficiency does not greatly affect the decision to invest (i.e. the NPV to the equity holder is much great than zero). The maximum expositions to firm and equity holders are roughly the same for the four scenarios.

To examine the full potential of a GIES system, and to provide a fair comparison with a non-GIES system, the remaining analyses consider grid import for GIES with storage efficiency given in Table 4.

### 5.2. Deterministic analysis

Base values (i.e. the most likely values) are used for the economic, financial, and technical inputs in the deterministic analysis. The economic viability of the system can be examined from the “policymaker” or “investor” perspective. A policymaker examines

**Table 8**  
Economic and financial results with electricity import and no electricity import for GIES.

Import grid electricity?	GIES scenarios			
	Optimistic ( $\eta_S = 88\%$ ) [3]		Pessimistic ( $\eta_S = 50\%$ ) [72]	
	Yes	No	Yes	No
Amount of energy import relative to GIES total energy output (%)	11.27	0	20.62	0
LCOE [€/kWh]	0.070	0.074	0.074	0.078
NPV to the firm [M€]	208	179	175	152
IRR to the firm [%]	11	10	10	10
NPV to equity holders [M€]	150	128	125	107
IRR to the equity holders [%]	14	13	13	12
Debt duration [yr]	10	11	11	11
Max. exposition firm [M€]	–181	–181	–181	–181
Total exposition firm [M€]	–1080	–1131	–1122	–1172
Max. exposition equity [M€]	–54	–55	–54	–55
Total exposition equity [M€]	–563	–599	–594	–627

systems considering both monetary and non-monetary aspects such as social benefits—including CO<sub>2</sub> emission reduction. An investor examines the monetary value of the project and considers policy schemes including CfD as a source of revenue. The next sections first examines the social desirability of the three systems from the policymaker's perspective, followed by the economic studies from the investor's perspective.

### 5.2.1. Policymaker's perspective (considering environmental externalities)

Environmental externalities refer to the “economic concept of uncompensated environmental effects of production and consumption that affect consumer utility and enterprise cost outside the market mechanism” [73, p. 1]. Carbon pricing is designed to capture the external costs of carbon emissions. A carbon price is a cost applied to carbon pollution, to encourage carbon pollution sources to reduce the amount of greenhouse gases they emit into the atmosphere [70].

Generators burning natural gas are the most common fossil fuel plant to produce electricity in the UK. The avoided cost of carbon emission is contributed by displacing natural gas with wind power, which is by far the largest form of renewable energy in the UK. In this scenario, we consider the wind energy will be exported to the grid. To examine the social benefits, the avoided cost of carbon emission is a virtual revenue source and is calculated with Equation (6).

$$\begin{aligned} \text{Avoided cost of carbon emission} \left[ \frac{\pounds}{\text{MWh}} \right] = & \\ \text{Cost of carbon emission} \left[ \frac{\pounds}{\text{tCO}_2} \right] & \quad (6) \\ * \text{Carbon emission intensity} \left[ \frac{\text{tCO}_2}{\text{MWh}} \right] & \end{aligned}$$

The cost of carbon emission and its related intensity can be found in Table 7. Subsequently, the revenue from reducing the CO<sub>2</sub> emission is calculated with Equation (7).

$$\begin{aligned} \text{Revenue from wholesale electricity sold [M}\pounds] = & \\ \left( \text{Avoided cost of carbon emission} \left[ \frac{\pounds}{\text{MWh}} \right] \right. & \\ \left. + \text{Average wholesale market price} \left[ \frac{\pounds}{\text{MWh}} \right] \right) & \quad (7) \\ \text{Electricity sold [MWh]} & \end{aligned}$$

Table 9 presents the economic and financial results for the three systems considering environmental externalities and, therefore, excluding revenues from CfD. The LCOE for wind-only is the lowest and is a reasonable value as examined in Ref. [74]. This implies that 1) the results of the model are realistic as it is aligned with the literature and 2) introducing energy storage to the wind power system increases the system's LCOE. This result is consistent with the literature (and industrial practice), for instance, as discussed by Milis et al. [75] and Zhang and Tang [76]. Energy storage is costly and, with these market conditions, generation alone without energy storage is the most profitable. With energy storage, there are energy losses due to the round-trip efficiency which contributes to the loss of revenue [31,77]. The LCOE for GIES is higher than non-GIES. This is due to a lower efficiency (i.e. energy output) for thermal energy storage, although the capital cost is lower. In this scenario, the wind-only system is the most profitable investment compared to GIES and non-GIES. Wind-only has the shortest debt duration and a positive NPV to equity holders. From the financial perspective, the investment return for GIES is higher than non-GIES with an NPV to equity holders' difference of 61 M€ (see Table 10).

**Table 9**

Economic and financial results for the three systems considering environmental externalities.

	Scenarios		
	GIES	Non-GIES	Wind-only
LCOE [€/kWh]	0.074	0.085	0.055
NPV to the firm [M€]	226	139	325
IRR to the firm [%]	11	8	15
NPV to equity holders [M€]	161	100	242
IRR to the equity holders [%]	14	11	19
Debt duration [yr]	12	14	9
Max. exposition firm [M€]	-181	-213	-127
Total exposition firm [M€]	-1195	-1692	-648
Max. exposition equity [M€]	-55	-64	-39
Total exposition equity [M€]	-644	-917	-325

**Table 10**

Economic and financial results for the three systems considering CfD.

	Scenarios		
	GIES	Non-GIES	Wind-only
LCOE [€/kWh]	0.074	0.085	0.055
NPV to the firm [M€]	179	91	263
IRR to the firm [%]	10	7	15
NPV to equity holders [M€]	128	64	198
IRR to the equity holders [%]	13	10	20
Debt duration [yr]	11	13	8
Max. exposition firm [M€]	-181	-213	-127
Total exposition firm [M€]	-1131	-1590	-609
Max. exposition equity [M€]	-55	-64	-39
Total exposition equity [M€]	-599	-847	-299

The “value at risk” is reduced with a smaller “maximum and total exposition for the firm and equity”. Due to costs and revenue, wind-only has the least maximum and total exposition for both equity and firm. Non-GIES has a larger maximum and total exposition than GIES; this is contributed by the high capital cost of batteries.

### 5.2.2. Investor's perspective

The investor's perspective considers CfD as a revenue source. Different to the policymaker's perspective, the results present in Table 9 are obtained by replacing the average wholesale market price and the avoided cost of carbon emission with the revenue from the CfD scheme. Also, under this scenario, wind-only is the most economic and profitable option. The NPV and IRR to equity holders are lower than from the policymaker's perspective. This is due to the duration of the CfD scheme (15 years) whereas the avoided cost of carbon emission lasts for the system's lifetime. The debt duration is shorter for the case with CfD. The higher revenue stream (CfD strike price > wholesale market price + avoided cost of carbon emission) will reduce the interest incurred and allow for repaying the debt earlier. This is evident that the total exposition firm and equity are less for the case with CfD.

In summary, the wind-only system has the least financial risk, higher financial returns, and minimal cost. This is consistent with the “real world” situation where the vast majority of wind farms do not have energy storage. The three systems provide significant positive economic results and social desirability. The avoided cost of carbon emission promotes the implicit assumption of the long-term continuity of the CfD scheme.

The remaining analyses consider the investment appraisal from the investor's perspective and examine the input uncertainties.

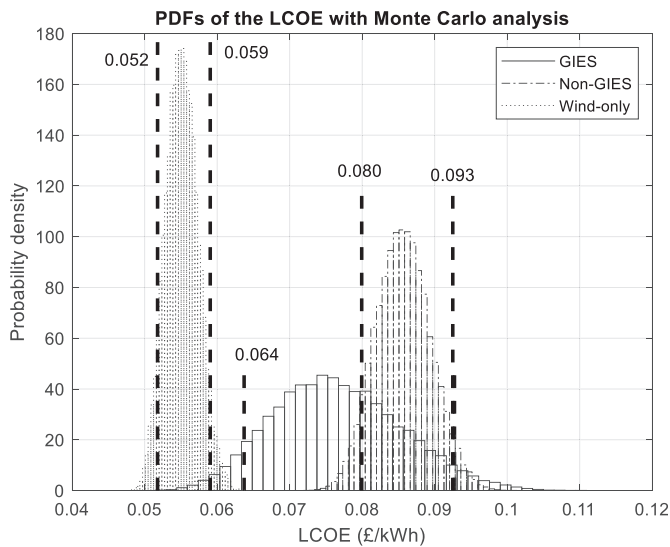

Fig. 4. PDFs of the LCOE with Monte Carlo analysis.

### 5.3. Risk analysis

The risk analysis gives Probability Distribution Functions (PDFs) for the NPV, LCOE, and IRR. This is particularly useful when there are relevant uncertainties. The risk analysis is conducted with a Monte Carlo analysis with random sampling based on the probability distribution defined for each input. The Monte Carlo stopping criteria is based on the convergence requirement, with a convergence tolerance at 1% and a confidence level of 95%.

Being a novel system, the technical, economic, and financing uncertainties are higher for GIES. Consequently, there is a wider LCOE uncertainty in Fig. 4 for GIES as it is currently in the study and feasibility stage, whereas non-GIES, being in bid/tender stage, have more cost certainty. Similar to the results from the deterministic analysis, the value and standard deviation of LCOE for wind-only are the lowest as the wind system is mature.

Fig. 5 presents the PDFs of the IRR. As the IRR is the discount rate when the NPV of the cash flow is equal to zero, a negative IRR implies that the initial investment is greater than the discounted cumulated cash flow for the operations.

IRR is a relative measure. For sense-making, it is necessary to refer to relevant values. For energy infrastructures, the European Commission Benchmark suggests a social discount rate (i.e. the WACC for reflecting the social view on how potential costs and benefits can be valued against present ones) of 5% [78]. The International Renewable Energy Agency mentioned that the WACC for renewable power generation for “Organization for Economic Cooperation and Development” countries and China to be at 7.5% [74]. Grant Thornton [79] reports the WACC to be at 8% for onshore wind. Cavazzi and Dutton [80] set the WACC for offshore wind energy to be at 10%.

The IRR for wind-only is the highest compared to GIES and non-GIES. This is due to the attractive revenue sources, especially the CfD. The IRRs are in the region of the WACCs, as discussed by various governments, industries, and academic institutions.

Fig. 6 presents the PDFs of the NPV to equity. For wind-only, the NPV is always in the positive region. This is confirmed by the popularity of wind-only investments in the last decade. As supported by the deterministic analysis, the variance is higher for GIES as there is a high variance for the system’s cost. The mean NPV for non-GIES is lower than GIES but with less variance. The probabilities for the NPV to be greater than zero for GIES and non-GIES are

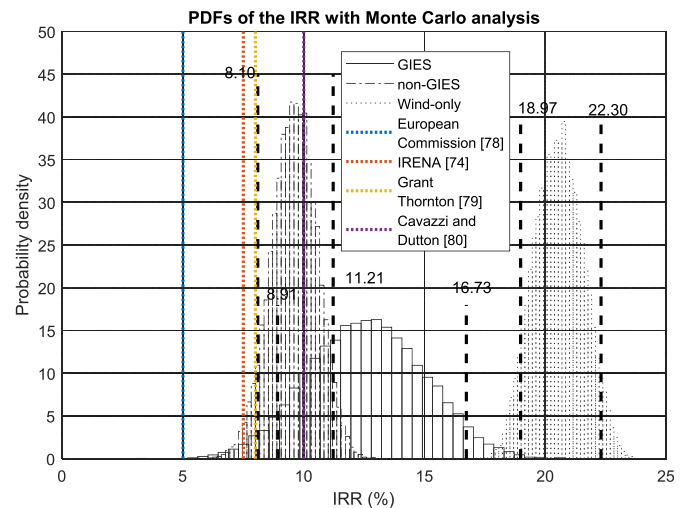

Fig. 5. PDFs of the IRR with Monte Carlo analysis.

100% and 99.8%, respectively, implying both investments are viable.

In summary, the investment in a wind farm alone is the most profitable and least risky. This is consistent with the plethora of this kind of system developed all over the world. Energy storage presents more risks and less returns than a wind farm.

### 5.4. Sensitivity analysis

This section identifies the most critical inputs affecting the NPV to equity and the LCOE. One input (e.g. capital cost) is varied by setting the value to the lower or upper limit and keeping the other factors to the base value. Fig. 7 and Fig. 8 present the results. Due to the limited space, the y-axis gives the index, and Tables 4–7 give the names of the inputs.

Fig. 7 shows the LCOE variation with different input variations. The LCOE variation for GIES is wider than non-GIES and wind-only due to the higher technical, economic, and financing uncertainties.

The most influential factors for GIES are the specific generator overnight cost and specific Balance of System for generator cost. The wind power generator cost is more prominent than the pumped-heat energy storage in Wind-TP. The low transmission

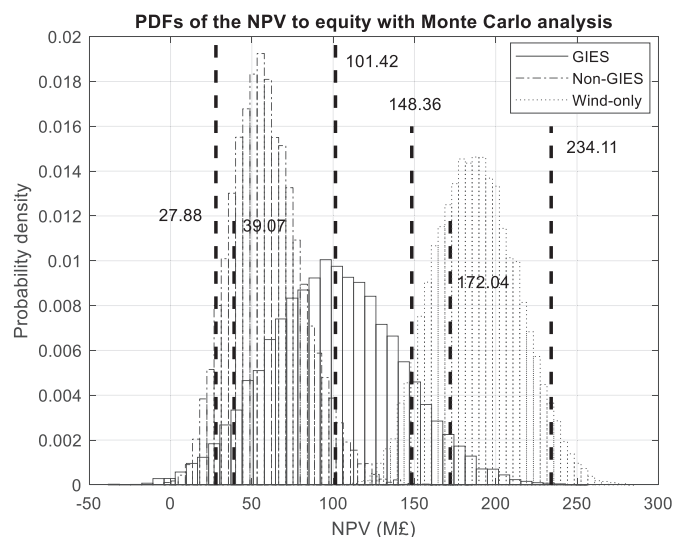

Fig. 6. PDFs of the NPV to equity with Monte Carlo analysis.

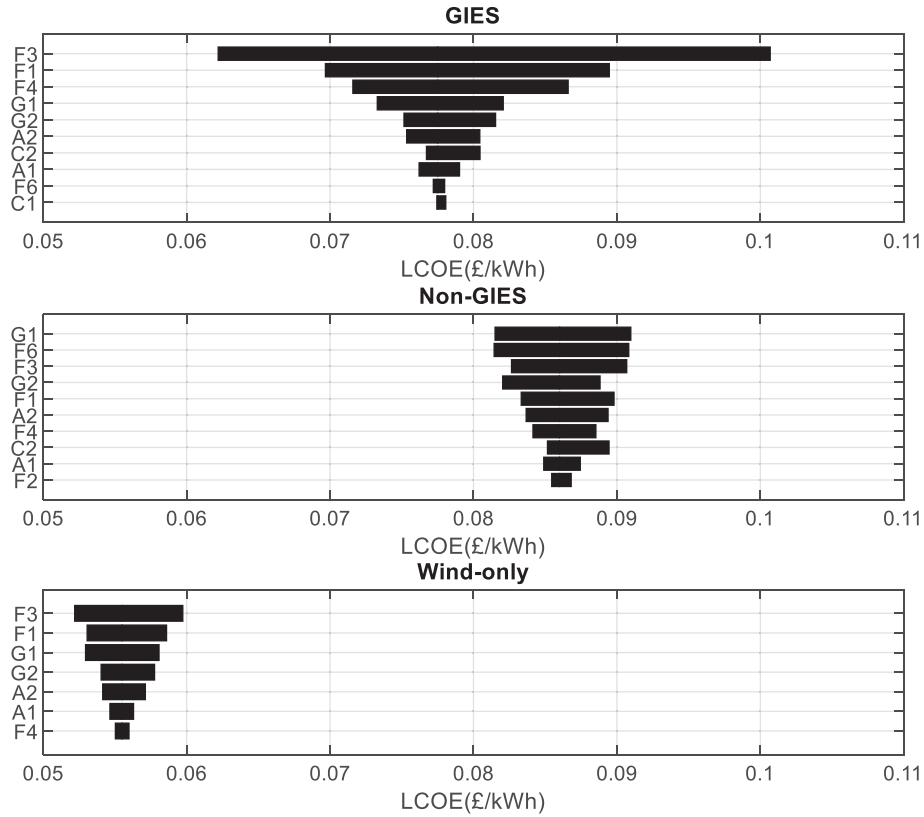

Fig. 7. Most influential inputs on the LCOE.

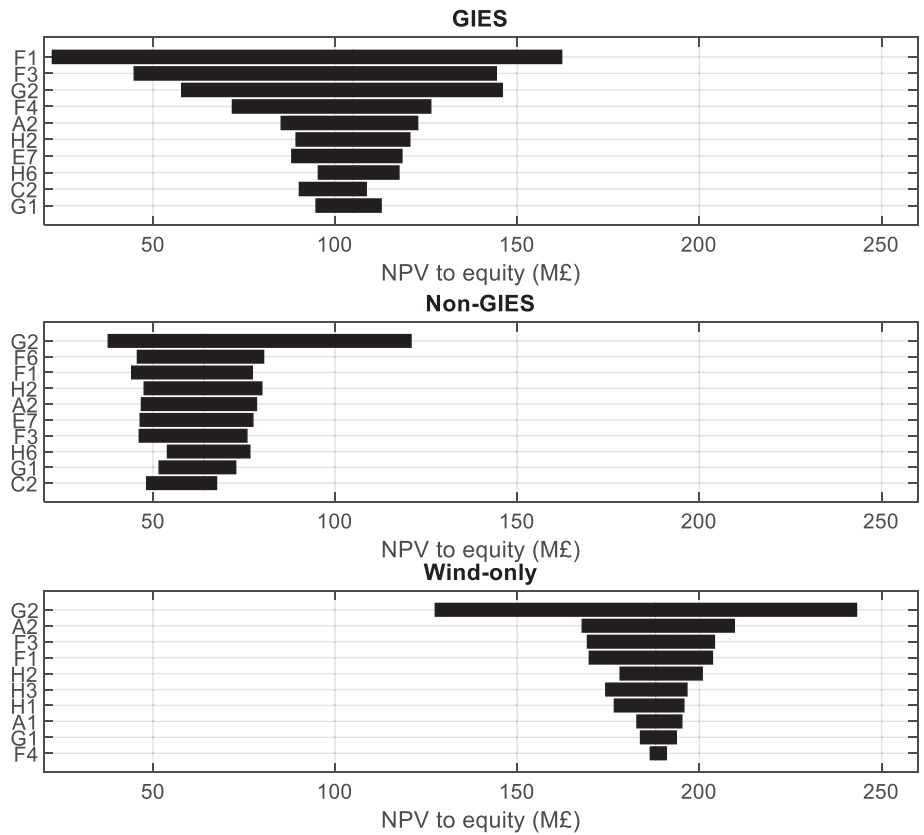

Fig. 8. Most influential inputs on the NPV to equity.

efficiency is also important for GIES as the energy losses can increase the LCOE. For non-GIES, the operating lifetime is one of the most important factors considering the LCOE. This is due to the relatively short lifespan for batteries. With a relatively high capital cost, similarly, the specific energy storage overnight cost is one of the most influential inputs for non-GIES. As discussed in Ref. [34,81], reducing the capital cost for batteries is important to make energy systems economical. For wind-only, the specific generator overnight cost, O&M cost, and cost of debt are the major factors affecting the LCOE. These inputs are reasonable as a wind farm is a capital-intensive investment.

Fig. 8 presents the most influential inputs on the NPV to equity for the three technologies. For GIES, similar to the findings from the economic aspect, the specific generator overnight cost and the O&M cost are the most influential factors of the NPV to equity. The wholesale market price, specific energy storage overnight cost, cost of equity, and transmission efficiency are the most influential inputs for non-GIES. For wind-only, the cost of equity is the most influential factor of the NPV to equity. The lifetime of the system is also a major factor along with the cost aspects (i.e. the specific generator overnight cost and O&M cost) and outweighs the revenue in importance.

In summary, based on the results from the risk analysis, the wind-only system is, again, more financially and economically attractive than GIES and non-GIES. Non-GIES generally use energy storage systems with high capital costs and short lifetimes. The transmission and storage efficiencies for GIES are relatively low. Considering the revenue, the CfD price is relatively high and accounts for more than other revenue sources such as STOR and Fast Reserve. The variance for the NPV to equity is greater for GIES as there is a larger input uncertainty. Data unavailability can increase variance as there is less information regarding the input [82].

## 6. Conclusions

There is a need for an increasing amount of non-dispatchable sources of electricity from low carbon power generators to support a low carbon economy. This increase causes several power grid issues related to stability and balancing energy supplies and demands. More energy storage capacity is needed to alleviate these issues by providing additional grid flexibility and resilience. The current “business as usual” or common form of storing electricity is by batteries (i.e. non-GIES). Although batteries such as Lithium-ion have high efficiency rates and response times, they suffer from relatively short lifespans and high capital costs. Moreover, batteries have an environmental impact both during construction and dismantling. A new class of energy storage system, known as GIES, stores energy during the transformation process from the primary energy form and electricity without using batteries. The energy is stored in the primary energy form.

This paper develops, applies, and tests a financial DCF model to examine the economic and financing prospects of GIES and non-GIES. The GIES system consists of pumped-heat energy storage connected to the wind turbine with a compressor. The non-GIES system consists of a wind turbine with a synchronized electrical generator, connected to a lithium-ion battery.

The novelties of this work are on the comprehensive state-of-the-art DCF model for GIES and non-GIES and the application in wind power generation. Unlike previous studies, this work simultaneously performs the economic and financial appraisal for the two most common forms of grid energy storage technologies with low carbon power generation. The model presented in this paper takes technological, economic, and financial uncertainties into account. There is a need for researchers to appreciate the strengths and acknowledge the weaknesses of GIES and non-GIES when

pairing energy storage with power generation. Concerning this study, there is a need for additional grid services data availability and transparency to minimize the variance in the DCF analysis.

Based on a UK case study with wind power, the economic and financial findings for GIES and non-GIES are summarized as the following:

- Under the current technical, economic, and financing environment, wind-only system without energy storage is the most economic and profitable investment. This is due to the avoidance of energy storage costs, energy losses due to round-trip efficiency, and receiving CfD payments. The present work shows that energy storage is, from the economic and financial perspective, not the best investment. However, energy storage is capable to deliver greater system values that cannot be reaped from low-carbon power generators. For example, there is a need to evaluate the technical and social benefits provided by energy storage during high-impact and low-probability power system events, i.e. power system resilience that causes cascading outages and blackouts. Blackouts would be probable if large-scale intermittent generations are not properly addressed, due to power imbalance which triggers system voltage and frequency violations.
- The economic and financial performance for GIES and non-GIES are comparable. The Monte Carlo analysis shows that the LCOE values for GIES and non-GIES are 0.05 £/kWh - 0.12 £/kWh and 0.07 £/kWh - 0.11 £/kWh, respectively, for a 100 MW wind power generator and 100 MWh energy storage. The IRR values for GIES and non-GIES are 2%–22% and 5%–14%, respectively. However, both systems require subsidies for grid energy storage to be economically and financially competitive as wind-only.

From an economic and financial perspective, this work has shown that GIES is a feasible method to store large scales of grid energy. Considering energy policy, there is a need for enhanced planning mechanisms for co-locating low-carbon power generation with energy storage systems; governments need to examine the type and amount of optimal incentives for low-carbon power generation and not forestall the need for storage. Specifically, current energy policies in the UK do not include energy storage in CfD allocations.

Additionally, there is a need for a holistic assessment of power system flexibility with GIES. The social benefit of co-locating systems needs to be examined in multi-dimensions, including economics, research and development priority (including extra funding for novel energy storage technologies), and current energy policy schemes. Future work includes examining the energy policies for energy storage and the financial performance of GIES concerning the CfD scheme, including examining other social benefits in the cost-benefit analysis, e.g. security of supply and grid stability. Furthermore, future research includes a real options analysis to determine real options (e.g. option to defer and option to build) for maximizing the profitability for both technologies. Having identified the key factors/inputs in contributing to the GIES and non-GIES costs, the contractual models could be proposed to minimize the investment risks and costs. Other types of electricity generation methods (e.g. solar and hydropower) for GIES will also be considered.

## Credit

Chun Sing Lai, Conceptualization, Methodology, Software, Investigation, Data curation, Formal analysis, Writing- original draft preparation, Writing-reviewing and editing. Giorgio Locatelli, Conceptualization, Methodology, Validation, Writing- original draft

preparation, Writing-reviewing and editing, Resources, Project administration, Supervision, Funding acquisition.

### Declaration of competing interest

The authors declare that they have no known competing financial interests or personal relationships that could have appeared to influence the work reported in this paper.

### Acknowledgements

This work is sponsored by the EPSRC grant “GIES: Generation Integrated Energy Storage: A Paradigm Shift” (EP/P022049/1). The authors express their gratitude to Mr Benito Mignacca for proof-reading the paper and providing insightful comments.

### Appendix A. Description of systems

#### 1. Wind-TP (GIES) system [5].

Fig. A.1 presents the novel Wind-TP system. The system consists of a wind power generator and pumped-heat energy storage. The synchronous generator produces electrical power from mechanical power derived from the slowly-rotating shaft of a large wind turbine rotor via the high-pressure gas circulation running in a closed circuit. In the basic operating mode, power is injected into the gas circuit through specialized low-speed nearly-adiabatic compress-

expander. The temperature variations make the compressor to draw greater work than the expander delivers. The system can recover energy from energy storage by including additional heat to the gas following the compression process and by adding coolth to the gas following the expansion. The expander gives greater power than the compressor draws. Wind-TP operates in five different operating modes as follows:

- Mode A: Direct power transmission from the primary compressor to the expander
- Mode B: Transmission from the primary compressor to expander with a proportion of energy flowing into energy storage
- Mode C: Transmission from the primary compressor to expander with a proportion of energy flowing out of energy storage
- Mode D: Power insertion with secondary compressor towards expander with a proportion of energy flowing into energy storage
- Mode E: Power insertion with secondary compressor towards expander with a proportion of energy flowing out of energy storage

For operating modes D and E only, the system works as independent energy storage that draws electricity from the grid and supplies electricity to the grid, respectively.

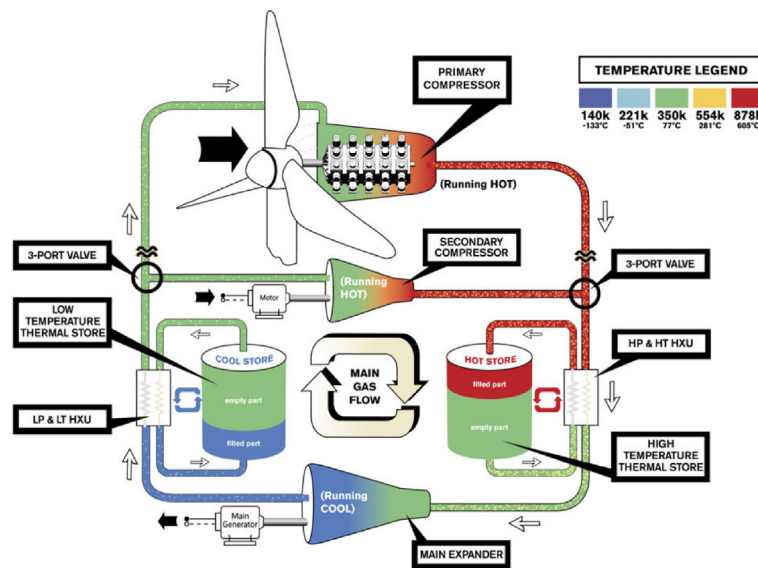

Fig. A.1. Wind-TP (GIES) system.

sors with very high isentropic efficiency. The power is extracted with an expander that is also nearly-adiabatic with great isentropic efficiency. In other operating modes, the variation in gas temperature following adiabatic compression/expansion allows the power transmission to store or recover energy from storage. For an ideal gas, the power extracted from an adiabatic compressor is proportional to the intake volume flow rate. The power released by an adiabatic expander is proportional to its intake volume flow rate. In a steady-state condition, the mass flow rate of gas around a closed circuit is constant at all points in the circuit. The intake volume flow rates are proportional to temperatures. The system can store energy by cooling the gas after compression (i.e. storing the heat) following by removing and storing coolth (coldness) from the gas after the

#### 2. Wind turbine with battery storage system (non-GIES) [6,83].

Fig. A.2 presents the wind turbine system coupled with a battery system [4,5]. The wind turns the blades, which spins the shaft of a generator to create electricity via electromagnetic induction. As the wind turbine system generates alternative current power, the bi-directional inverter is used to convert the alternating current to direct current, and vice versa during charging. A bidirectional inverter is a power electronic device that regulates and monitors the flow of power between a direct current bus and an alternating current grid and to restrict the voltage expanse at the former to only a certain permissible range of voltages. A bi-directional inverter does not only perform the direct current to alternating

current conversion but also performs the conversion of alternating current power to direct current power.

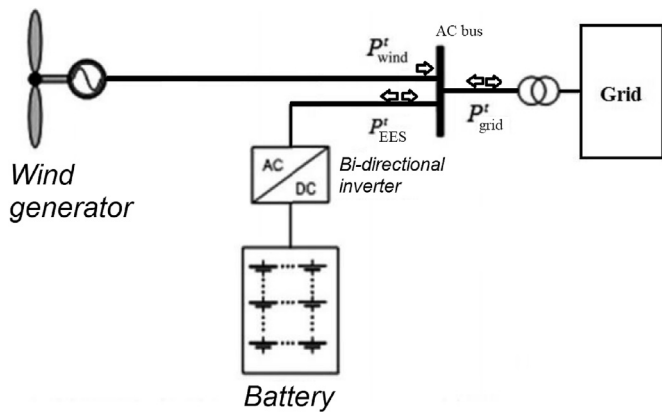

**Fig. A.2.** Wind turbine with a battery storage system (non-GIES).  $P$ ,  $t$ , AC, DC, and EES denote power (kW), time (hour), alternating current, direct current, and electrical energy storage, respectively.

## References

- [1] Lebedeva NP, Boon-Brett L. Considerations on the chemical toxicity of contemporary Li-ion battery electrolytes and their components. *J Electrochem Soc* 2016;163(6):A821–30.
- [2] Nitta N, Wu F, Lee JT, Yushin G. Li-ion battery materials: present and future. *Mater Today* 2015;18(5):252–64.
- [3] Garvey SD, et al. On generation-integrated energy storage. *Energy Pol* 2015;86:544–51.
- [4] WindTP," [Online]. Available: <http://www.wind-tp.com>. (visited on 23<sup>rd</sup> June 2020).
- [5] Garvey SD, et al. Analysis of a wind turbine power transmission system with intrinsic energy storage capability. *Wind Eng* 2015;39(2):149–73.
- [6] Xia S, Chan K, Luo X, Bu S, Ding Z, Zhou B. Optimal sizing of energy storage system and its cost-benefit analysis for power grid planning with intermittent wind generation. *Renew Energy* 2018;122:472–86.
- [7] Affonso CM, Kezunovic M. Technical and economic impact of PV-BESS charging station on transformer life: a case study. *IEEE Transactions on Smart Grid* 2018;10(4):4683–92.
- [8] Cucchiella F, D'Adamo I, Gastaldi M. The economic feasibility of residential energy storage combined with PV panels: the role of subsidies in Italy. *Energies* 2017;10(9):1434.
- [9] Casati E, Casella F, Colonna P. Design of CSP plants with optimally operated thermal storage. *Sol Energy* 2015;116:371–87.
- [10] Chen R, Rao Z, Liao S. Determination of key parameters for sizing the heliostat field and thermal energy storage in solar tower power plants. *Energy Convers Manag* 2018;177:385–94.
- [11] Wu Y-T, Li Y, Ren N, Zhi R-P, Ma C-F. Experimental study on the thermal stability of a new molten salt with low melting point for thermal energy storage applications. *Sol Energy Mater Sol Cell* 2018;176:181–9.
- [12] Zhao B-c, Cheng M-s, Liu C, Dai Z-m. Conceptual design and preliminary performance analysis of a hybrid nuclear-solar power system with molten-salt packed-bed thermal energy storage for on-demand power supply. *Energy Convers Manag* 2018;166:174–86.
- [13] Bayon A, et al. Techno-economic assessment of solid-gas thermochemical energy storage systems for solar thermal power applications. *Energy* 2018;149:473–84.
- [14] Dutta P. High temperature solar receiver and thermal storage systems. *Appl Therm Eng* 2017;124:624–32.
- [15] Aydin D, Casey SP, Riffat S. The latest advancements on thermochemical heat storage systems. *Renew Sustain Energy Rev* 2015;41:356–67.
- [16] Benato A, Stoppato A. Pumped thermal electricity storage: a technology overview. *Thermal Science and Engineering Progress* 2018;6:301–15.
- [17] Benato A. Performance and cost evaluation of an innovative pumped thermal electricity storage power system. *Energy* 2017;138:419–36.
- [18] Smallbone A, Jülch V, Wardle R, Roskilly AP. Levelised cost of storage for pumped heat energy storage in comparison with other energy storage technologies. *Energy Convers Manag* 2017;152:221–8.
- [19] Davenne T, Garvey S, Cardenas B, Simpson M. The cold store for a pumped thermal energy storage system. *Journal of Energy Storage* 2017;14:295–310.
- [20] Energy storage: Tracking clean energy progress," International Energy Agency (IEA). [Online]. Available: <https://www.iea.org/tcep/energyintegration/energystorage/>. (visited on 23<sup>rd</sup> June 2020).
- [21] Lai CS, Jia Y, Lai LL, Xu Z, McCulloch MD, Wong KP. A comprehensive review on large-scale photovoltaic system with applications of electrical energy storage. *Renew Sustain Energy Rev* 2017;78:439–51.
- [22] Amirante R, Cassone E, Distaso E, Tamburrano P. Overview on recent developments in energy storage: mechanical, electrochemical and hydrogen technologies. *Energy Convers Manag* 2017;132:372–87.
- [23] Lai CS, Locatelli G, Pimm A, Li X, Lai LL. Levelized cost of electricity considering electrochemical energy storage cycle-life degradations. *Energy Procedia* 2019;158:3308–13.
- [24] Lai CS, et al. Levelized cost of electricity for photovoltaic/biogas power plant hybrid system with electrical energy storage degradation costs. *Energy Convers Manag* 2017;153:34–47.
- [25] Gong K, et al. A zinc-iron redox-flow battery under \$100 per kWh of system capital cost. *Energy Environ Sci* 2015;8(10):2941–5.
- [26] Sanz L, Lloyd D, Magdalena E, Palma J, Kontturi K. Description and performance of a novel aqueous all-copper redox flow battery. *J Power Sources* 2014;268:121–8.
- [27] Tohidi Y, Gibescu M. Stochastic optimisation for investment analysis of flow battery storage systems. *IET Renew Power Gener* 2018;13(4):555–62.
- [28] Mejía-Giraldo D, Velásquez-Gomez G, Muñoz-Galeano N, Cano-Quintero JB, Lemos-Cano S. A BESS sizing strategy for primary frequency regulation support of solar photovoltaic plants. *Energies* 2019;12(2):317.
- [29] Jones C, Peshev V, Gilbert P, Mander S. Battery storage for post-incentive PV uptake? A financial and life cycle carbon assessment of a non-domestic building. *J Clean Prod* 2017;167:447–58.
- [30] Locatelli G, Invernizzi DC, Mancini M. Investment and risk appraisal in energy storage systems: a real options approach. *Energy* 2016;104:114–31.
- [31] Lai CS, Locatelli G, Pimm A, Tao Y, Li X, Lai LL. A financial model for lithium-ion storage in a photovoltaic and biogas energy system. *Appl Energy* 2019;251:113179.
- [32] Sainati T, Locatelli G, Smith N, Brookes N, Olver G. Types and functions of special purpose vehicles in infrastructure megaprojects. *Int J Proj Manag* 2020;38(5):243–55.
- [33] Lai CS, McCulloch MD. Sizing of stand-alone solar PV and storage system with anaerobic digestion biogas power plants. *IEEE Trans Ind Electron* 2017;64(3):2112–21.
- [34] Lai CS, McCulloch MD. Levelized cost of electricity for solar photovoltaic and electrical energy storage. *Appl Energy* 2017;190:191–203.
- [35] Levelized cost and levelized avoided cost of new generation resources in the annual energy outlook. International Energy Agency (IEA); 2019. Feb. 2019. [Online]. Available: <https://www.eia.gov/outlooks/aeo/pdf/electricity-generation.pdf> (visited on 23<sup>rd</sup> June 2020).
- [36] Section 6 - Renewables," National statistics, Energy trends: renewables, Department for Business, Energy & Industrial Strategy, U.K. [Online]. Available: [https://assets.publishing.service.gov.uk/government/uploads/system/uploads/attachment\\_data/file/789370/Renewables\\_March\\_2019.pdf](https://assets.publishing.service.gov.uk/government/uploads/system/uploads/attachment_data/file/789370/Renewables_March_2019.pdf). (visited on 25<sup>th</sup> June 2020).
- [37] Li X, Chalvatzis K, Stephanides P. Innovative energy islands: life-cycle cost-benefit analysis for battery energy storage. *Sustainability* 2018;10(10):3371.
- [38] Electricity storage and renewables: costs and markets to 2030. International Renewable Energy Agency; 2017 [Online]. Available: [https://www.irena.org/-/media/Files/IRENA/Agency/Publication/2017/Oct/IRENA\\_Electricity\\_Storage\\_Costs\\_2017.pdf](https://www.irena.org/-/media/Files/IRENA/Agency/Publication/2017/Oct/IRENA_Electricity_Storage_Costs_2017.pdf) (visited on 25<sup>th</sup> June 2020).
- [39] "Balance-of-system equipment required for renewable energy systems," Energy Saver, energy.gov [Online]. Available: <https://www.energy.gov/energysaver/balance-system-equipment-required-renewable-energy-systems>. (visited on 25<sup>th</sup> June 2020).
- [40] Dobre D. Capital cost estimating - owner's costs and EPC contract. *Learn Cost Estimating* 2017 [Online]. Available: <https://www.learncoestimate.com/capital-cost-estimating-owners-costs/> (visited on 25<sup>th</sup> June 2020).
- [41] Cost and performance characteristics of new generating technologies, annual energy outlook. U.S. Energy Information Administration; 2019 (EIA), Jan. 2019. [Online]. Available: [https://www.eia.gov/outlooks/aeo/assumptions/pdf/table\\_8.2.pdf](https://www.eia.gov/outlooks/aeo/assumptions/pdf/table_8.2.pdf) (visited on 25<sup>th</sup> June 2020).
- [42] Renewable power generation costs in 2018. International Renewable Energy Agency; June 2019. [Online]. Available: <https://www.irena.org/publications/2019/May/Renewable-power-generation-costs-in-2018> (visited on 25<sup>th</sup> June 2020).
- [43] Ren J, Ren X. Sustainability ranking of energy storage technologies under uncertainties. *J Clean Prod* 2018;170:1387–98.
- [44] Obi M, Jensen S, Ferris JB, Bass RB. Calculation of levelized costs of electricity for various electrical energy storage systems. *Renew Sustain Energy Rev* 2017;67:908–20.
- [45] Luo X, Wang J, Dooner M, Clarke J. Overview of current development in electrical energy storage technologies and the application potential in power system operation. *Appl Energy* 2015;137:511–36.
- [46] Zakeri B, Syri S. Electrical energy storage systems: a comparative life cycle cost analysis. *Renew Sustain Energy Rev* 2015;42:569–96.
- [47] Pumped heat electrical storage," European Association for Storage of Energy. [Online]. Available: [http://ease-storage.eu/wp-content/uploads/2016/07/EASE\\_TD\\_Mechanical\\_PHEs.pdf](http://ease-storage.eu/wp-content/uploads/2016/07/EASE_TD_Mechanical_PHEs.pdf). (visited on 25<sup>th</sup> June 2020).
- [48] Working Paper, no. 2019-06 Lutsey N, Nicholas M. Update on electric vehicle costs in the United States through 2030. The International Council on Clean Transportation; 2019 [Online]. Available: <https://theicct.org/publications/update-US-2030-electric-vehicle-cost> (visited on 26<sup>th</sup> June 2020).
- [49] Policy paper contracts for difference. Department for Business, Energy & Industrial Strategy; Jan. 2019 [Online]. Available: <https://www.gov.uk/government/publications/contracts-for-difference/contract-for-difference> (visited on 25<sup>th</sup> June 2020).

- [50] Electricity market reform: contracts for difference. UK: GOV; Feb 2017 [Online]. Available: <https://www.gov.uk/government/collections/electricity-market-reform-contracts-for-difference> (visited on 25<sup>th</sup> June 2020).
- [51] The CFD scheme," Low Carbon Contracts Company, Electricity Settlements Company. [Online]. Available: <https://www.lowcarboncontracts.uk/the-cfd-scheme>. (visited on 25<sup>th</sup> June 2020).
- [52] "Third part and industry charges," Npower Limited. [Online]. Available: <https://www.npower.com/business-solutions/your-account/billing/charges/>. (visited on 25<sup>th</sup> June 2020).
- [53] Download current and historical CFD Register data," Low Carbon Contract Company, Electricity Settlements Company. [Online]. Available: <https://www.lowcarboncontracts.uk/download-current-and-historical-cfd-register-data>. (visited on 25<sup>th</sup> June 2020).
- [54] N2EX day ahead auction prices: Feb. 2019 - March 2019," NORDPOOL, [Online]. Available: <https://www.nordpoolgroup.com/Market-data1/GB/Auction-prices/UK/Hourly/?view=table>. (visited on 25<sup>th</sup> June 2020).
- [55] Short Term Operating Reserve (STOR)," National Grid ESO, [Online]. Available: <https://www.nationalgrideso.com/balancing-services/reserve-services/short-term-operating-reserve-stor>. (visited on 25<sup>th</sup> June 2020).
- [56] Short Term Operating Reserve annual market report 2016/2017," National Grid ESO, [Online]. Available: <https://www.nationalgrideso.com/document/103336/download>. (visited on 25<sup>th</sup> June 2020).
- [57] STOR market information report: Tender Round 25," National Grid ESO, [Online]. Available: [https://www.nationalgrideso.com/sites/eso/files/documents/STOR%20Market%20Information%20Report%20for%20TR25\\_v2.pdf](https://www.nationalgrideso.com/sites/eso/files/documents/STOR%20Market%20Information%20Report%20for%20TR25_v2.pdf). (visited on 25<sup>th</sup> June 2020).
- [58] "Fast Reserve," National Grid ESO, [Online]. Available: <https://www.nationalgrideso.com/balancing-services/reserve-services/fast-reserve>. (visited on 25<sup>th</sup> June 2020).
- [59] Firm Fast Reserve post assessment tender report - March 2019," National Grid ESO, [Online]. Available: <https://www.nationalgrideso.com/document/139336/download>. (visited on 25<sup>th</sup> June 2020).
- [60] "Department of Energy (DOE) global energy storage database," Office of Electricity Delivery & Energy Reliability, Sandia National Laboratories, [Online]. Available: <https://www.energystorageexchange.org/projects>. (visited on 25<sup>th</sup> June 2020).
- [61] Kilkki O, Alahäivälä A, Seilonen I. Optimized control of price-based demand response with electric storage space heating. *IEEE Transactions on Industrial Informatics* 2015;11(1):281–8.
- [62] Kumar R. 6 - discounted cash flow valuation models. In: *Valuation R Kumar*, editor. San Diego: Academic Press; 2016. p. 145–85.
- [63] Dysert L, Bowman L, Bredehoeft P, Melamed D, Pickett T, Plumery R. Cost estimate classification system - as applied in engineering, procurement, and construction for the process industries. I. March 2016 [Online]. Available: [https://web.aacei.org/docs/default-source/toc/toc\\_18r-97.pdf?sfvrsn=4](https://web.aacei.org/docs/default-source/toc/toc_18r-97.pdf?sfvrsn=4) (visited on 25<sup>th</sup> June 2020).
- [64] Pumped heat electrical storage: mechanical energy storage," European Association for Storage of Energy, [Online]. Available: [http://ease-storage.eu/wp-content/uploads/2016/07/EASE\\_TD\\_Mechanical\\_PHEs.pdf](http://ease-storage.eu/wp-content/uploads/2016/07/EASE_TD_Mechanical_PHEs.pdf). (visited on 25<sup>th</sup> June 2020).
- [65] Jaiswal A. Lithium-ion battery based renewable energy solution for off-grid electricity: a techno-economic analysis. *Renew Sustain Energy Rev* 2017;72: 922–34.
- [66] Barré O, Napame B. Concentrated windings in compact permanent magnet synchronous generators: managing efficiency. *Machines* 2016;4(1):2.
- [67] Inflation calculator," Bank of England. [Online]. Available: <https://www.bankofengland.co.uk/monetary-policy/inflation/inflation-calculator>. (visited on 25<sup>th</sup> June 2020).
- [68] Noothout P, Jager Dd, Tesnière L, Rooijen Sv, Karypidis N. DiaCore: the impact of risks in renewable energy investments and the role of smart policies. Co-funded by the Intelligent Energy Europe Programme of the European Union Feb. 2016 [Online]. Available: <http://diacore.eu/images/files2/WP3-Final%20Report/diacore-2016-impact-of-risk-in-res-investments.pdf> (visited on 25<sup>th</sup> June 2020).
- [69] Electricity generation costs. Department for Business, Energy & Industrial Strategy Nov. 2016 [Online]. Available: [https://assets.publishing.service.gov.uk/government/uploads/system/uploads/attachment\\_data/file/566567/BEIS\\_Electricity\\_Generation\\_Cost\\_Report.pdf](https://assets.publishing.service.gov.uk/government/uploads/system/uploads/attachment_data/file/566567/BEIS_Electricity_Generation_Cost_Report.pdf).
- [70] UK Hirst D. Carbon Price Floor (CPF) and the price support mechanism. House of Commons Library Jan. 2018 [Online]. Available: <https://commonslibrary.parliament.uk/research-briefings/sn05927/> (visited on 25<sup>th</sup> June 2020).
- [71] 2019 government Greenhouse gas conversion factors for company reporting. UK: Department of Business, Energy & Industrial Strategy; Aug. 2019 [Online]. Available: [https://assets.publishing.service.gov.uk/government/uploads/system/uploads/attachment\\_data/file/829336/2019\\_Green-house-gas-reporting-methodology.pdf](https://assets.publishing.service.gov.uk/government/uploads/system/uploads/attachment_data/file/829336/2019_Green-house-gas-reporting-methodology.pdf) (visited on 25<sup>th</sup> June 2020).
- [72] Sarbu I, Sebarchievi C. A comprehensive review of thermal energy storage. *Sustainability* 2018;10(1).
- [73] Environmental externalities, glossary of statistical terms. Organisation for Economic Co-operation and Development March 2003 [Online]. Available: <https://stats.oecd.org/glossary/detail.asp?ID=824> (visited on 25<sup>th</sup> June 2020).
- [74] Renewable power generation costs in 2017. International Renewable Energy Agency; 2018 [Online]. Available: [https://www.irena.org/-/media/Files/IRENA/Agency/Publication/2018/Jan/IRENA\\_2017\\_Power\\_Costs\\_2018.pdf](https://www.irena.org/-/media/Files/IRENA/Agency/Publication/2018/Jan/IRENA_2017_Power_Costs_2018.pdf) (visited on 25<sup>th</sup> June 2020).
- [75] Milis K, Peremans H, Van Passel S. Steering the adoption of battery storage through electricity tariff design. *Renew Sustain Energy Rev* 2018;98:125–39.
- [76] Zhang S, Tang Y. Optimal schedule of grid-connected residential PV generation systems with battery storages under time-of-use and step tariffs. *Journal of Energy Storage* 2019;23:175–82.
- [77] Shahzad MK, Zahid A, ur Rashid T, Rehan MA, Ali M, Ahmad M. Techno-economic feasibility analysis of a solar-biomass off grid system for the electrification of remote rural areas in Pakistan using HOMER software. *Renew Energy* 2017;106:264–73.
- [78] Guide to cost-benefit analysis of investment projects. European Commission Dec. 2014 [Online]. Available: [https://ec.europa.eu/inea/sites/inea/files/cba\\_guide\\_cohesion\\_policy.pdf](https://ec.europa.eu/inea/sites/inea/files/cba_guide_cohesion_policy.pdf).
- [79] Renewable energy discount survey results - 2018. Grant Thornton Jan. 2019 [Online]. Available: <https://www.grantthornton.co.uk/globalassets/1.-member-firms/united-kingdom/pdf/documents/renewable-energy-discount-rate-survey-results-2018.pdf>.
- [80] Cavazzi S, Dutton A. An Offshore Wind Energy Geographic Information System (OWE-GIS) for assessment of the UK's offshore wind energy potential. *Renew Energy* 2016;87:212–28.
- [81] Wood DL, Li J, Daniel C. Prospects for reducing the processing cost of lithium ion batteries. *J Power Sources* 2015;275:234–42.
- [82] Lai CS, et al. A robust correlation analysis framework for imbalanced and dichotomous data with uncertainty. *Inf Sci* 2019;470:58–77.
- [83] Jabir M, Azil Illias H, Raza S, Mokhlis H. Intermittent smoothing approaches for wind power output: a review. *Energies* 2017;10(10):1572.