

**Optimisation of a Water Company's Waste  
Pumping Asset Base with a Focus on Energy  
Reduction**

**A thesis submitted to Brunel University London  
for the degree of Doctor of Philosophy**

**Alex Gray**

**2022**

***College of Engineering, Design and Physical  
Sciences Brunel University London***

## Abstract

Water companies use a significant quantity of electricity for the operation of their clean and wastewater assets. Rising energy prices have led to higher energy bills within the water companies, which has increased operating costs. Thus, improvements in demand side energy management are needed to increase efficiency and reduce costs, which forms the premise for this research project.

Thames Water Utilities Ltd has identified that improvements in demand side energy management is required and is currently researching various methods to reduce energy consumption. One initiative included the upgrade of a variety of site telemetry assets. By deploying these new telemetry assets, Thames Water Utilities Ltd are more able to liberate the asset data and as such, be able to make informed decisions on how better to control and optimise the target sites, which is where this research project has seen further opportunities. This enhanced telemetry and SCADA infrastructure will enable successful research to further develop an intelligent integrated system that tackles pump scheduling and process control with the emphasis on energy management.

The use of modern techniques, such as artificial intelligence, to optimise the network operation is gradually gaining traction. The balance between implementing new technology (with the benefits it may bring) and reluctance to change from the incumbent operating model will always provide challenges in the technology adoption agenda.

The main work of this research project included the physical surveying of a wastewater hydraulic catchment, inclusive of all wet well dimensions, lidar overlays, and pump electrical power characteristics. These survey results were then able to be programmed by the research into the company's hydraulic model to enable a higher degree of accuracy in the modelling, as well as enabling electrical power as a measurable output. From here, the model was then able to be optimised, focussing on electrical energy as an output variable for reduction.

The research concluded that electrical energy consumption over time can be reduced using the aforementioned strategies and as such recommends further work to move from the model environment to physical architecture. It does so with the key message that risk tolerances on water levels must be pre-agreed with hydraulic specialists prior to deployment.

## Acknowledgements

I would like to express the sincerest appreciation and thanks to my supervisors, Dr Ioana Pisica, Professor Gareth Taylor, David Walters and Rachel Cunningham, for all their valuable support and guidance during my research project. The four aforementioned people have made themselves available to me during this eight-year part-time PhD journey, which has had many ups and downs, twists and turns, and I can without question credit them all for why this research has been possible.

Unconditional thanks, gratitude and appreciation to my wife for all her sacrifices, love, support, perseverance and motivation. Also, my two children who missed out on some time with me whilst I studied. I would not have kept going without them.

My parents and sister who have been part of my entire journey, through thick and thin, from the start.

Two key people in my initial decision to start this project, Dennis Fitzpatrick and Nick Mills, thank you for the belief.

Special thanks go to Pascal Lang, William Neale, Geoff Brown, Alan Jeffery and Magdalena Kedzia who, along with David and Rachel, formed part of great steering group. They all showed great patience in me, bringing me up to speed with an incredibly powerful piece of software and for allowing me to borrow a license key for so long.

To Leo Kiernan, a simple conversation with me in the Island Road library meant more than you can possibly imagine and was probably the defining point in me carrying on. Thank you.

To all my work colleagues, past and present, who have helped me along the way, whether that was help with surveying or just giving me a motivational kick to keep going, I've needed plenty of those.

Finally, to all my friends and those who put their faith in me.

Futurum nostrum a nobis scriptum

**Contents**

**Abstract .....i**

**Acknowledgements ..... ii**

**List of Figures .....vi**

**List of Tables..... viii**

**Nomenclature.....ix**

**Definitions and Important Terms .....xi**

**List of Publications ..... xii**

**Introduction ..... 1**

    1.1 *Energy Management in Water* .....2

        1.1.1 Electricity costs.....3

        1.1.2 Regulatory compliance .....3

        1.1.3 Carbon emissions.....3

    1.2 *Governance*.....4

    1.3 *Aim and objectives*.....4

        1.3.1 Research aim.....4

        1.3.2 The Objectives and Scope of the Research .....5

    1.4 *Significance and novelty of the research* .....6

    1.5 *Structure of the thesis* .....7

    1.6 *Summary*.....7

**Electrical Energy and Control Within the Water Industry .....9**

    2.1 *The Energy Consumption Challenge* .....9

    2.2 *Control and Automation* .....10

    2.3 *The Approach to Energy Improvements* .....12

    2.4 *Active System Control*.....13

    2.5 *Innovative Optimisation Strategies – a literature review* .....15

        2.5.1 Fuzzy Systems for Optimisation.....16

        2.5.2 Artificial Neural Networks for Optimisation .....19

        2.5.3 Optimisation using the Tynemarch Systems MISER-PSL .....22

        2.5.4 EPANET .....25

        2.5.5 Ant Colony Optimisation.....29

        2.5.6 Optimisation success within a high demand water pumping system .....34

    2.6 *Consideration of Additional Influencing Factors* .....39

        2.6.1 Data for modelling .....39

        2.6.2 Enhanced Pump Station Controller.....40

        2.6.3 Networks and Hydraulic Capacity .....42

        2.6.4 Balancing Services.....42

        2.6.5 TRIAD Event Handling .....44

        2.6.6 Ethical Considerations .....45

        2.6.7 Risk.....48

2.7	<i>Discussion</i> .....	49
2.8	<i>Summary</i> .....	50
<b>Energy Submetering Within a Typical Water Company</b> .....		<b>52</b>
3.1	<i>Introduction</i> .....	52
3.2	<i>Electrical Asset Obsolescence</i> .....	56
3.2.1	High and Medium Voltage Feeders.....	56
3.2.2	Pre-existing discrete connection LV power meter.....	57
3.2.3	Pre-existing Fieldbus connection LV power meter.....	57
3.2.4	Installation of a new power monitoring system within an electrical asset.....	58
3.3	<i>Power Monitoring</i> .....	59
3.4	<i>Data Architecture</i> .....	61
3.4.1	The Purdue Model.....	61
3.4.2	A Water Company’s Data Architecture.....	63
3.4.3	Data acquisition.....	64
3.4.4	SCADA.....	66
3.5	<i>The Benefits of Power Monitoring</i> .....	66
3.6	<i>Summary</i> .....	67
<b>Standardised SCADA Templating</b> .....		<b>69</b>
4.1	<i>Introduction</i> .....	69
4.2	<i>Legacy SCADA Architecture</i> .....	71
4.3	<i>Revised SCADA Architecture</i> .....	75
4.3.1	Computing Resource Architecture.....	79
4.3.2	Application Resource Architecture.....	81
4.3.3	System Security.....	81
4.4	<i>Standardised SCADA Platform</i> .....	82
4.4.1	Symbols.....	82
4.4.2	Dynamic Symbols.....	83
4.4.3	Colouring the process.....	84
4.4.4	Object Templates.....	85
4.4.5	Asset Tagging.....	86
4.5	<i>Human Factors</i> .....	89
4.5.1	System Access.....	90
4.5.2	Adoption of revised Tagging Concerns.....	91
4.5.3	Adoption of overall system concerns.....	93
4.6	<i>Summary</i> .....	94
<b>Catchment Selection and Model Reconstruction</b> .....		<b>95</b>
5.1	<i>Selecting a Catchment</i> .....	95
5.2	<i>Use of Clustering to Assist Identification</i> .....	96
5.3	<i>The Bordon Wastewater Catchment</i> .....	101
5.3.1	GIS Validation.....	104
5.4	<i>Model Validation</i> .....	107
5.4.1	Conversion to metres above ordnance datum.....	107
5.4.2	Lidar overlay and Rising Main Construction.....	110
5.4.3	Modelling Pump Curves within the Hydraulic Model.....	112

5.4.4	Calculating Electrical Energy within the Hydraulic Model .....	113
5.5	Summary .....	119
<b>Optimisation of a Wastewater Catchment .....</b>		<b>121</b>
6.1	<i>The Design Space</i> .....	121
6.2	<i>Problem formulation</i> .....	122
6.3	<i>Choice of strategy</i> .....	124
6.4	<i>Computational Setup</i> .....	126
6.5	<i>Optimisation Environment Workflow</i> .....	128
6.6	<i>Design of Experiments</i> .....	130
6.6.1	Pseudo Random .....	131
6.6.2	Sobol.....	133
6.6.3	Uniform Latin Hypercube.....	134
6.6.4	Summary.....	136
6.7	<i>Application of Multi-Strategy Optimiser</i> .....	140
6.7.1	PilOPT™ Solver .....	141
6.8	<i>Local Optimisation</i> .....	142
6.8.1	Gradient Descent .....	143
6.8.2	Newton-Raphson .....	144
6.8.3	Levenberg-Marquardt .....	145
6.9	<i>Additional Global Strategy Test</i> .....	151
6.10	<i>Final Savings</i> .....	151
<b>Conclusions and Recommendations.....</b>		<b>153</b>
7.1	<i>Research aims and objective achievements</i> .....	153
7.2	<i>Conclusions</i> .....	154
7.2.1	Control Room Strategy .....	154
7.2.2	Catchment selection.....	155
7.2.3	Model Validation .....	156
7.2.4	Wastewater Catchment Optimisation.....	157
7.3	<i>Contribution to knowledge</i> .....	158
7.4	<i>Limitations and suggestions for future research</i> .....	160
7.4.1	Software and Hardware Availability.....	160
7.4.2	Optimisation Algorithm Deployment .....	161
7.4.3	The Objective.....	165
7.5	Summary .....	165
<b>References .....</b>		<b>167</b>

## List of Figures

Figure 1-1 Basic Wet Well Configuration, from [3].....	2
Figure 2-1 Membership function for the chosen variables adapted from Kissi, Ramdani [36] .....	16
Figure 2-2 Membership function for the chosen variables adapted from [42] .....	18
Figure 2-3 Box and whisker plot output for flooding prediction [43].....	21
Figure 2-4 Hydrograph for flooding prediction [43] .....	21
Figure 2-5 Box and whisker plot output for flooding prediction [43].....	22
Figure 2-6 Anglian Water and Tynemarch – Demand Correlation 1 [2] .....	24
Figure 2-7 Anglian Water and Tynemarch – Demand Correlation 2 [2] .....	24
Figure 2-8 EPANET Case Study Schematic Network [51] .....	27
Figure 2-9 Travelling Sales Man Example [1].....	30
Figure 2-10 Example system curve from frictionally dominated system [63].....	36
Figure 2-11 Example system curve from static dominated system [63] .....	37
Figure 2-12 Lots Road Storm Sewage Pumping Station [75].....	46
Figure 2-13 Lots Road Storm Sewage Pumping Station [76].....	47
Figure 3-1 An example of an HV / LV Bus Coupling [87].....	54
Figure 3-2 HV Feeder and Instrumentation .....	56
Figure 3-3 Existing Analogue Power Meter .....	57
Figure 3-4 Existing Fieldbus Power Meter .....	58
Figure 3-5 Unbalanced Load 3-Phase 4-Wire Connection .....	60
Figure 3-6 Unbalanced Load 3-Phase 3-Wire Connection .....	60
Figure 3-7 Balanced Load 3-Phase 3 Connection.....	61
Figure 3-8 Graphical overview of Theodore J. Williams Purdue model [96].....	62
Figure 3-9 Energy data flow architecture .....	64
Figure 4-1 Typical Sewage Treatment Process Block Diagram [97] .....	72
Figure 4-2 Large Clean Water Process Block Diagram [97].....	73
Figure 4-3 Interconnectivity of Operational Data Systems [97] .....	78
Figure 4-4 Small System Computational Architecture [97] .....	79
Figure 4-5 Medium System Computational Architecture [97] .....	80
Figure 4-6 Large System Computational Architecture [97].....	80
Figure 4-7 Examples of legacy pump symbols [97] .....	83
Figure 4-8 Examples of legacy screen symbols [97] .....	84
Figure 4-9 Example of new pump and blower symbols [97] .....	84
Figure 5-2 Cluster silhouette values .....	99
Figure 5-1 Latitude/Longitude cluster data on the optimised pump stations using K-Means .....	99
Figure 5-3 Bordon map with population statistics [131] .....	101
Figure 5-4 Bordon catchment before GIS validation.....	105
Figure 5-5 Bordon catchment after GIS validation.....	106
Figure 5-6 Example wet well from photo taken during surveys .....	108
Figure 5-7 Cross sectional view of typical UK SPS [132] .....	109
Figure 5-8 Cross section of a pump station and lidar overlay.....	111
Figure 5-9 Example Site Drive Pump Nameplate .....	112
Figure 6-1 Example of single peak design space .....	125
Figure 6-2 Example of multi-peak design space.....	126
Figure 6-3 Optimisation workflow as assembled within the modeFRONTIER™ graphical user interface	129
Figure 6-4 Random scatter matrix, clear lack of uniform distribution within the design space. ....	132
Figure 6-5 Sobol scatter matrix, better uniformity when compared to random scatter .....	134
Figure 6-6 Uniform Latin hypercube scatter matrix, some discrete areas of limited distribution. ....	136
Figure 6-8 Analysis of Sobol Grouping for First 84 DOE Selection .....	137
Figure 6-9 Analysis of Reduced Factorial Grouping for First 84 DOE Selection .....	137
Figure 6-10 Analysis of Random Grouping for First 84 DOE Selection.....	137
Figure 6-7 Analysis of 2-Layer Full Factorial Grouping for First 84 DOE Selection .....	137
Figure 6-8 Analysis of Random Grouping for First 84 DOE Selection.....	137
Figure 6-11 Analysis of Uniform Latin Hypercube Grouping for First 84 DOE Selection .....	138
Figure 6-12 Optimisation Software Capped Full Factorial Designs .....	139

Figure 6-13 Example Inverse Peak..... 143  
Figure 6-14 Final results plot feasible designs per strategy, taken from modeFRONTIER™ results..... 148  
Figure 6-15 Final results plot feasible and unfeasible designs, taken from modeFRONTIER™ results .. 149  
Figure 6-16 Final Result Chart from Raw Data – Plotted by author from results ..... 150  
Figure 7-1 Sensitivity analysis for flood volume..... 163  
Figure 7-2 Sensitivity analysis for pump power ..... 164



## List of Tables

Table 2-1 Energy Consumption for the 12 months ended 31st March 2021 .....	9
Table 2-2 Case Study Observed Results taken from (Shao et al., 2019).....	27
Table 2-3 Case Study Observed Results taken from (Shao et al., 2019).....	28
Table 2-4 STOR - Technical requirements (National Grid, 2016).....	43
Table 3-1 Rockwell PLC Scaling Example.....	65
Table 4-1 Example Asset Standard Colours for Process Streams .....	85
Table 5-1 Bordon wastewater pumping station list .....	102
Table 5-2 Example wet-well chamber converted to mAOD .....	110
Table 5-3 Typical Pump Efficiency Values (Karassik et al., 2008) .....	116
Table 6-1 Sample Extract from Model CSV Export.....	128
Table 6-2 Feasible PilOPT™ Results .....	141
Table 7-1 Sensitivity analysis from initial ULH84 .....	161

## Nomenclature

ACO	Ant Colony Optimisation
AD	Anaerobic Digestion
ANN	Artificial Neural Networks
AOT	ArchestrA Object Toolkit
API	Application Programming Interface
ASC	Active System Control
ASM	Active System Management
AV	Antivirus
CAPEX	Capital Expenditure
CHP	Combined Heating and Power
CSO	Combined Sewage Overflows
DC	Domain Controller
DNO	Distribution Network Operator
DNP3	Distributed Network Protocol Version 3
DOE	Design of Experiments
DSL	Digital Subscriber Lines
EA	Environmental Agency
EPSM	Enhanced Pumping Station Management
FIS	Fuzzy Inference System
FLOC	Functional Location Code
GA	Genetic Algorithm
GIS	Geographic Information System
GR or GRNode	Galaxy Repository (Wonderware ArchestrA central configuration area)
GUI	Graphical User Interface
GWh	Gigawatt Hour
HR	Human Resources
I/O	Inputs / Outputs
ICCP	Inter-Control Centre Protocol
iDRAC	iDRAC = Integrated Dell Remote Access
IPR	Intellectual Property Rights
KPI	Key Performance Indicator
LAN	Local Area Network
LWT	London Water Treatment (Thames Water Utilities Ltd Database)
mAOD	Metres Above Ordnance Datum
MEICA	Mechanical, Electrical, Instrumentation, Control and Automation
MET Office	Meteorological Office
MW	Megawatt
NETSO	National Electricity Transmission System Operator
OLE	Object Linking and Embedding for Process Control (OPC)
OPC	Open Platform Communications
OPEX	Operational Expenditure

OPF	Optimal Power Flow
ORPD	Optimal Reactive Power Dispatch
OS	Operating System
P&ID	Piping and Instrumentation Diagram
PA	Programmable Automation
PBD	Process Block Diagram
PE	Population Equivalent
PLC	Programmable Logic Controller
PSTN	Public Switched Telephone Network
PV	Photovoltaic
PWT	Provinces Water Treatment (Thames Water Utilities Ltd Database)
RAM	Random Access Memory
RDP	Remote Desktop Protocol
RDS	Remote Desktop Session
RGF	Rapid Gravity Filters
ROC	Renewable Obligation Certificate
RODC	Read Only Domain Controller
ROI	Return on Investment
RSM	Response Surface Methodology
RTC	Real Time Control
RTU	Remote Telemetry Unit
SAS	Surplus Activated Sludge
SCADA	Supervisory Control and Data Acquisition
SLA	Service Level Agreement
SNMP	Simple Network Management Protocol
STOR	Short Term Operating Reserve
STW	Sewage Treatment Works
TEP	Telemetry Enhancement Package
THP	Thermal Hydrolysis Plant
TNUoS	Transmission Network Use of System
TS	Terminal Server
UKWIR	UK Water Industry Research
V-CPU	Virtual Central Processing Units
VH	Virtual Host
VM	Virtual Machine
VSD	Variable Speed Drive
WSUS	Windows Server Update Services
WTW	Water Treatment Works
WWT	Wastewater Treatment (Thames Water Utilities Ltd database)

## Definitions and Important Terms

Historian	A SCADA server that is used to store historical data from time series signals. E.g., flow, pressure, level. Sometimes referred to as the Tier 1 historian.
Tier 2 Corporate Historian	An enterprise level IT server that comprises a secondary database and which ingests the historical data initially presented at the SCADA historian.
AMP – Asset Investment Period	The regulated capital investment cycle that all water companies must operate under. This is governed by the economic regulator Ofwat and determines how much investment can be applied for and what companies can charge customers.

## List of Publications

### Journals

A. D. L. Gray, I. Pisica, G. A. Taylor and L. Whitehurst, "A Standardised Modular Approach for Site SCADA Applications Within a Water Utility," in IEEE Access, vol. 5, pp. 17177-17187, 2017, doi: 10.1109/ACCESS.2017.2654685.

### Conferences

A. D. Gray, I. Pisica, G. Taylor and E. Katsou, "Optimising the use of electrical energy within the waste water industry through improved utilization of process control and automation," 2015 50th International Universities Power Engineering Conference (UPEC), 2015, pp. 1-6, doi: 10.1109/UPEC.2015.7339883.

A. D. L. Gray, I. Pisica, G. A. Taylor and L. Whitehurst, "Exploiting granular electrical energy data and the challenges a utility company faces with an ageing asset base," 2017 52nd International Universities Power Engineering Conference (UPEC), 2017, pp. 1-6, doi: 10.1109/UPEC.2017.8231900.

# Chapter 1

## Introduction

Active system control, also known as real-time control and more recently, active system management, is a form of control strategy that, if exploited effectively, can yield better electrical energy efficiencies when tackling the water-energy nexus. An example of this application and energy saving would be within the control and operation of a water company's wastewater network, in particular, the electrical pumps that distribute the wastewater around the piped system. Although the concept from which these control strategies derive is not new, its adoption and application within the water industry is.

A wastewater system is controlled in 'real time' when process variables (levels, flows, energy) are monitored and at the same time, used to operate manipulated variables (actuators, pumps and valves) during the process sequence. For example, a water pump is controlled using a pressure set setpoint. The device to be controlled (the pump) has a variable speed control parameter which regulates the electrical motor's revolutions per minute (rpm). The variable being controlled (the pressure) is measured using a transducer physically connected to a pipe. A device that connects between pressure input and pump speed output is configured to use the input. Based on another variable, a desired user setpoint, control the pump speed to achieve the desired output.

The very nature of this real-time control has been prevalent within wastewater treatment plants for many years, with programmable logic controllers (PLCs) being used to automate the different process streams. By contrast, the wastewater networks and sewage pumping stations (SPS) serving these treatment plants do not generally comprise PLC control. Pumps are controlled locally at the SPS using discrete hardwired signal controls from ultrasonic level systems.

Figure 1-1 shows the basic architecture of a sewage wet well and pumping system. These wet wells are located across urban and rural areas and differ in size and complexity, which is generally proportional to the number of customers each station serves. The pumps are driven by electrical motors, which can range from very small (1.5kW) to very large (>1MW); however, the most common units generally range from 1.5kW to 50kW.

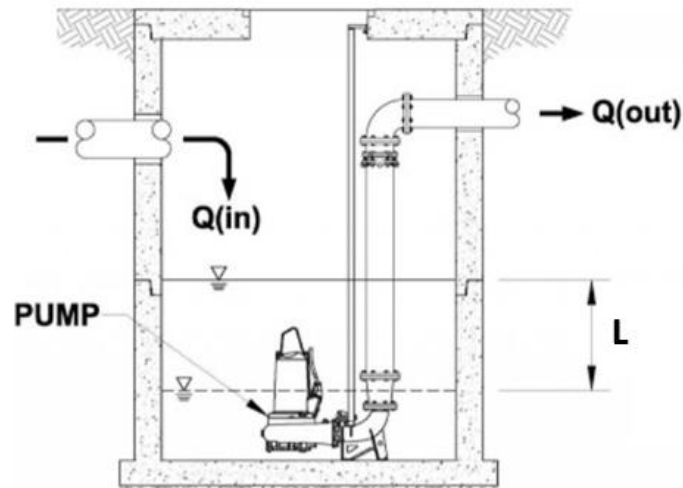

Figure 1-1 Basic Wet Well Configuration, from [3]

Where:

1.  $Q(\text{in})$  = Flow entering the well
2.  $Q(\text{out})$  = Pumped flow leaving the well
3.  $L$  = Level (the upper line is the start pump level and the lower line the stop pump level)

Intelligent devices have only recently been available / affordable for the deployment across SPSs that enable a more granular (per pump) approach to energy monitoring and control via an integrated telemetry and SCADA platform. Furthermore, the change in communications type; legacy public switched telephone network (PSTN) dial-up to an always connected digital service are only recently adopted developments in remote monitoring technology.

### **1.1 Energy Management in Water**

Research data from European countries (Germany and Spain) show that the electrical energy demand for wastewater treatment accounts for about 1% of the total energy consumption for that country [4]. Further research in [5] suggests that in the U.S. electricity consumption in wastewater treatment plants can account for up to 8% of the total electrical energy consumption. Although not from the UK, these figures represent one way, by analogy, of indicating the electrical energy consumption of the UK's wastewater pumping system.

There are several factors that make technological changes to the wastewater pumped network, and in particular those that deliver energy savings, of interest to water companies.

### *1.1.1 Electricity costs*

The combined energy usage for a UK water company's waste pumping and treatment equates to approximately 41% of total energy usage, with treatment using 30% and pumping using 11% [6]. From further discussions with other industry professionals, the research concludes that a 10% saving on the contribution from pumping alone would equate to a capital saving of approx. £1.3m per annum.

### *1.1.2 Regulatory compliance*

With stricter regulatory compliances from The UK Water Services Regulation Authority (Ofwat) and with a far more customer-focused business model [7], the waste networks and their incumbent control strategies require a revised model in the way the companies operate them [8]. Where the current operating model uses direct physical variables to form its control sequence (well level rises, pumps switch on), there is an increasing need to consider more in terms of the holistic inputs that feed in and out of the model; rainfall, triad sequences, upstream / downstream flow profiles and primarily the interconnection between all SPS's as a collective system.

### *1.1.3 Carbon emissions*

Data presented in [9] states a carbon impact of 0.27442 kgCO<sub>2</sub>e / kWh consumed in the UK (inclusive of grid losses). When considering a UK water company consumes 1.35TWh, of which 1TWh is consumed directly from the grid [10], this equates to an annual 274.5 kilotons of carbon. When coupled with a commitment to reduce CO<sub>2</sub> emissions by 80% by 2050 (1990 baseline) through the Climate Change Act [11] this only serves to increase focus on the reduction of electrical energy consumption through multiple strategic objectives, of which demand response is one.

The main focus of this research is to investigate the current electrical energy demand of a wastewater catchment, with a view that the overall system (the catchment) can be considered as an integrated process. From here, the research aims to reduce the overall energy expenditure by optimising the controlling parameters of the subject catchment.



## **1.2 Governance**

This PhD project was carried out at Brunel University London with a sponsorship by Thames Water Utilities Ltd as a part-time programme. The research was carried out by the author at both Brunel University London and a mixture of Thames Water Utilities Ltd operational sites to ensure the full coverage of research facilities and supervision.

## **1.3 Aim and objectives**

### *1.3.1 Research aim*

The research proposes that; by investigating the behaviours of a wastewater catchment, using offline hydraulic simulation, and by considering the sewer network as a single process, the existing telemetry structure across a water company's sites could be further developed and optimised. This would then look to achieve a flexible asset base that further adapts to external influences dynamically with substantial financial and environmental benefits.

This research aims to present an optimised wastewater catchment, using energy reduction as the primary target objective variable. It will achieve this by physically surveying a wastewater hydraulic catchment, inclusive of all wet well dimensions, lidar overlays, and pump electrical power characteristics. Optimisation will come from using electrical energy consumption from pumping systems as the primary variable for control and, as long as no environmental breaches (pollution, spills etc.) occur, will look to reduce this consumption by employing natural capacity within the wastewater network and therefore reducing the frequency of pumping operations.

The use of supervisory control and data acquisition (SCADA) systems will form the principal mechanism for deploying any new control strategies that the research identifies. Therefore, a critical review of these systems and their modular application is also undertaken as part of the research.

### 1.3.2 *The Objectives and Scope of the Research*

**Objective 1:** Review of the utilisation of a common object template library developed by a water company for modernisation by standardising the approach to SCADA systems. A further review of the impact of change on a water company's control room.

The scope for achieving objective one investigates the application of a newly deployed standard object template and how this provides modular building blocks for asset configuration and visual interfaces. Further investigation also explores an understanding of human factors associated with change (and the resistance towards it) within control rooms across multiple demographics. For the primary objective of deploying new control strategies within an incumbent operating model, these factors must be considered.

**Objective 2:** Identify a wastewater catchment that can be hydraulically modelled and optimised in an offline environment, and which is suitable for the application of future 'physical' trials as a result of a positive outcome.

The scope required to meet objective two will include a review of a water company's entire waste pumping station estate and will build an understanding of the telemetry outstation systems across this geographic landscape. The review of the telemetry connectivity and asset type, including whether existing remote-control functionality is available, is to be performed in order to further understand any future deployment constraints and required investment to remediate.

**Objective 3:** Validate the chosen wastewater catchments hydraulic model with the real-world system. Where there are any gaps in the data, the catchment will be surveyed in order to update these.

To tackle objective three, the research scope will inspect an existing hydraulic software model and look to validate this model against the real-world physical system. For any deployment of a control strategy to be adopted by a water company's operational team, significant evidence through trials must be presented. This is so that confidence in its application does not lead to unwanted outcomes, such as pollution and spills.

**Objective 4:** Automate an optimisation sequence that will use the updated hydraulic model and perform iterative model runs with a focus on reducing the electrical energy expenditure of the system under inspection.

To achieve objective four, the research scope will include building upon the validation of the hydraulic software model and then further explore, through optimisation, how the system's electrical energy consumption can be reduced. The assumption employed here is that a reduction in wastewater pump run times will lead to a reduction in electrical energy consumption.

#### **1.4 Significance and novelty of the research**

This research provides information on some of the current issues with energy expenditure in the control and distribution of UK wastewater networks. This will substantiate water companies' inefficiency of the incumbent operating models and enable them to explore remodelling the systems as a collective process rather than a series of individual sites that do not consider their upstream / downstream counterparts. The research is focussing on the waste water catchments only at this time as, in the opinion of the author through the limited evidence within the literature, these areas have a gap in their current understanding. They are also large consumers of electrical energy and hence, qualify as a very suitable study case.

Further, this research will use clustering techniques to identify suitable wastewater catchments based on prior telemetry system upgrades, enabling the application of any 'real world' deployment. From this, the research will align the software model with the real-world system through a series of surveys and parametric data conversions such that the model is no longer built from assumed data and uses the 'as installed' data from the hydraulic systems as well as the pump assets.

From a review of the current literature, it is in the authors opinion that the novelty of this work comes from the alignment of the real-world parameters within the hydraulic model, such that it fully reflects the physical world it represents. In addition, the use of pump head / discharge data to generate electrical power as an output has not been seen to date within the current literature.

Finally, the research will use a series of software optimisation techniques that, through an application programming interface (API), will seek to reduce energy consumption within the target wastewater catchment, something not yet presented within the literature to date. The outcome will be used to present a confident theory that enables a proof of concept to be deployed in the real world. Further, the successful application of using API's to interconnect hydraulic modelling systems to third party optimisation packages will provide a framework for a scalable architecture that is not purely limited

to wastewater catchments. The learnings and results will be applicable to clean water hydraulic systems as well as the treatment and production of waste and water facilities respectively.

### **1.5 Structure of the thesis**

The contents of this thesis are structured as follows. Chapter 2 discusses a review of strategy and enabling projects used to date within the water industry to leverage higher granularity electrical energy data. Chapter 3 provides a critical analysis of the use of common object templating within a water company's SCADA estate. Chapter 4 details the critical review of the literature corresponding to the optimisation challenge. Chapter 5 presents the researchers approach to identify a suitable waste-water network for study using K-Means clustering and presents how the identified waste network was surveyed, and the hydraulic model improved to determine electrical energy reporting. Chapter 6 introduces the optimisation techniques and presents the resulting energy reduction output. Finally, Chapter 7 concludes the research contributions and discusses deploying a more intelligent control strategy to reduce electrical energy across a water company's estate.

### **1.6 Summary**

This research focuses on the issues related to energy expenditure in the control and distribution of wastewater networks in the UK. It aims to highlight the inefficiencies of current operating models used by water companies and proposes a collective approach to remodelling these systems, considering both upstream and downstream counterparts. The research primarily focuses on wastewater catchments, as there is limited understanding in this area, and these catchments are significant consumers of electrical energy, making them suitable for study.

The research intends to use clustering techniques to identify suitable wastewater catchments based on prior telemetry system upgrades. By aligning the software model with real-world systems through surveys and data conversions, the researchers aim to ensure that the model is built using actual data from the hydraulic systems and pump assets, rather than assumed data. This alignment of real-world parameters within the hydraulic model is considered novel, as is the use of pump head and discharge data to generate electrical power as an output.

The research also plans to employ software optimisation techniques, utilising an application programming interface (API), to reduce energy consumption within the

target wastewater catchment. This approach, not yet explored in the literature, aims to present a proof of concept that can be implemented in the real world. Additionally, the successful integration of hydraulic modelling systems with third-party optimisation packages through APIs will establish a scalable architecture applicable not only to wastewater catchments but also to clean water hydraulic systems and waste and water treatment facilities.

In summary, this research aims to address energy inefficiencies in UK wastewater networks by proposing collective system remodelling, utilising real-world data in hydraulic models, and applying software optimisation techniques through API integration. The results and learnings from this research are expected to have implications beyond wastewater systems and can be applied to other hydraulic systems as well.

# Chapter 2

## Electrical Energy and Control Within the Water Industry

Water companies use a significant quantity of electricity for the operation of their clean and wastewater assets. Rising energy prices have led to higher energy bills within the water companies, which has increased operating costs. Customers and stakeholders have an increased awareness of the environmental cost and carbon footprint associated with electrical generation, which is an added driver for water companies to become more sustainable and reduce consumption. Improvements in demand side energy management are therefore, needed to increase efficiency and reduce costs.

### 2.1 The Energy Consumption Challenge

There are increasing moral and financial obligations upon all energy users to maintain alignment with the UK government's Net Zero 2030 strategy [12], and factors from the current energy trilemma [13], to ensure as rapid a move to a greener approach as possible. Within a water company, this challenge will be significantly impactful from the operation and ownership of the install base as this area comprises a large number of electrically demanding loads. Thus, reducing the company's carbon footprint and operating costs will need to employ some relatively aggressive reduction challenges.

This has inevitably led to an increased emphasis on the implementation of demand side energy management. For example, Thames Water Utilities Ltd currently consumes 1.5TWh of electrical energy per annum [14], which is listed as the single largest operational cost after salaries.

The current research focuses on the wastewater systems within a UK company. A breakdown of the energy consumption for these systems from [14] is shown below.

**Table 2-1 Energy Consumption for the 12 months ended 31st March 2021**

<b>Area</b>	<b>MWh</b>
Energy consumption–sewage collection	122,386.559
Energy consumption–sewage treatment	663,172.244
<b>Total</b>	<b>785,558.803</b>

Renewables play a large part in achieving key performance indicators (KPI's) and currently Thames Water Utilities Ltd reports an approximate renewable energy capability of 476GWh, generating 311GWh of electrical energy and using some of this by feeding it back into the processes associated with water treatment and distribution.

What's not used is exported to the national grid, which alleviates demands from other users [14].

Where renewables are a proven source of carbon-friendly energy production, there has, more recently, been an increase in focus on addressing the balance. As the population continues to grow, so will the demands for services and thus the energy required. It is widely accepted that the inevitable need for more energy to support these services is an obvious fact (and that renewable should be the no.1 option for increasing output). However, the idea of simply generating more to meet rising demands should be revised. There should be additional focus on how the current demand can also be reduced without impacting the services and, ultimately, the customer [15-17].

## **2.2 Control and Automation**

SCADA is a technology that enables users with the ability to log data from a variety of remote units as well as execute control commands to them. It reduces the risk of an operator needing to be constantly present or regularly attend site locations when the system operates normally. It includes, but is not limited to: the operator interface and application data manipulation [18].

Due to distributed nature of a water company's physical asset base, the use of automation and the remote nature of the control it brings means it is an area of significant importance as it forms the full automation layer of all processes associated with water and wastewater collection, treatment, and transportation.

The most important objectives surrounding the implementation of a water company's human machine interface systems are the optimisation strategies with regard to the automation of the plant process, which is required to maintain quality and reduce losses [19, 20]. The introduction of automation has, over time, reduced the levels of manual operation from across the asset workflow. Moreover, the conversion to automated processes has enabled quality and quantity data to be processed and monitored more accurately [21].

With the increase in processing power available and new Telemetry, PLC and SCADA products offering better integration techniques, including near real-time control, there still remains a slow adoption of the standard building blocks used in automation. For the majority, feed-back control is still the norm. However, there is a growing interest in a newer form of control system that offers feed-forward control.

In feed-forward, control action is planned entirely in advance of its execution. With feedback, the control action depends entirely on incoming sensory information [22]. In a feed-forward system, the control variable adjustment (an example might include the starting or stopping of a pump) is not error-based. Instead, it is based on the knowledge extracted from the process in the form of mathematical models and knowledge about, or measurements of, the process disturbances [23].

If the pumping station example shown in Figure 1-1 of this research is considered, then the application of feedback control forms the everyday business-as-usual strategy. This comprises a level controller that measures the level in the well, executes a pump start command, and at the point the level reaches the lower bound (the feedback), the pump stops. Feed-forward control might look at the data from external influences and variables such as,

- incoming weather patterns (a deluge or prolonged dry spell),
- other wet wells connected to the network and their levels,
- the receiving sewage treatment works and its current incoming flow rates,
- peak demand and initiatives from an energy supplier to reduce energy.

From here, a broader, more holistic approach to control execution could be applied. By investigating, and where not detrimental to the core operation on the removal of wastewater, the implementation of control strategies that consider these external influences, could yield benefits in the form of efficiencies and cost reduction.

This form of control will inevitably become a more pressing need within the industry due to the ever-increasing pressure on energy efficiency targets. However, before any changes to an incumbent operating model are made, confidence must be built within the operational asset owners in the safety of its implementation. Any benefits returned from reduced energy consumption will be lost quickly if the new control created an operational issue that led to an event, such as pollution or failed customer service.

The need for knowing the state of a wastewater catchment in real time may not have been evident in the past, as the sewer systems were less visible (only very basic telemetry data existed). Also, the level of ambition in terms of system performance was not as highly pressured as it is today. Until now, the technology in terms of computational power and online data acquisition has been inadequate [24].



This chapter will present a critical review of the literature regarding the optimisation and reduction of energy on assets within the water industry. It will further illustrate the ongoing energy initiatives within the water industry and explore current system control developments.

### **2.3 The Approach to Energy Improvements**

From a Thames Water Utilities Ltd annual performance report [14], Sarah Bentley (CEO) stated that; *“after a hugely difficult year for our world, Thames Water Utilities Ltd have the opportunity to rebuild it in a green and sustainable way, and this year COP26 gives the world the chance to set the right ambitions for our planet. Thames Water Utilities Ltd.’s renewable energy generation is often seen as a nice to have, but working together with the Government, our stakeholders, regulators, and supply chain, we can be an important part of energy transition in the UK.”*

Some of the renewable initiatives that have successfully contributed to a yearly output of 311GWh of renewable electrical energy include:

- The installation of an additional 990kW of photovoltaic (PV) solar energy generation across ten operational treatment plants.
- Queen Elizabeth II Reservoir Solar Project - In March 2016, Lightsource Renewable Energy successfully completed and connected Europe’s largest floating solar farm, installing 6.3MW on the Queen Elizabeth II Reservoir near London [25].
- A project involving the installation of a small (11.5kW) hydroelectric turbine at Oxford sewage treatment outfall.
- Further investment of £250m in renewable energy from sewage sludge; installation of thermal hydrolysis process (THP) plants, that condition sludge prior to digestion which accelerates the digestion process, reduces hydraulic retention times and extracts more biogas, which in turn is used to generate more electricity.
- Scientists from Thames Water Utilities Ltd, in partnership with the University of Surrey, have perfected the art of transforming sewage into green electricity at peak times, including additional advances in research that led to improved efficiencies in the process of anaerobic digestion (AD) [26, 27]

As with any new scheme, such as the ones listed above, there will always be the need for significant capital expenditure (Capex), this will offset any return on investment

(ROI), and although the evidence suggests increased savings in the future, the stakeholders will have an expenditure threshold that cannot be breached.

Along with renewables, there is an intensified focus on the 'optimisation' of the existing asset base.

These schemes will sometimes require more effort in gaining approval compared to the traditional renewal schemes, as with all innovative projects, higher levels of risk vs any guaranteed payback. However, with the increased volatility of the energy markets, cost-benefit analysis demands that these innovations can no longer be ignored. Some of the ongoing 'asset optimisation' projects within Thames Water Utilities Ltd include:

- The installation of circa 400 electrical energy meters (energy meters fitted further down the process distribution system to provide more granular data on individual electrical assets). These provide enhanced visualisation of the site demands and have to date enabled further optimisation of site performances; this has reduced local demand by 6.5GWh [28]. The research has undertaken a critical analysis of this strategy which is presented in detail in Chapter 3 of this thesis.
- The optimisation of 10 large strategic pumping systems, increasing the use of gravity and reducing / optimising water pressure, reducing the demand by 5.8 GWh
- The optimisation of 8 sewage aeration treatment systems, improving their controls; thus, achieving a total power reduction of 3.7 GWh.”

## **2.4 Active System Control**

Active system control (ASC), also known within the industry as real-time control (RTC) and more recently, active system management (ASM), is a new form of control technology within the wastewater networks. However, the concept from which this is derived is not new. A wastewater catchment is controlled in 'real time' if process variables are monitored within the system and, (almost) at the same time, used to operate actuators during the process flow [29]. This control philosophy has been prevalent within the treatment process plants for wastewater systems for many years. However, only until very recently have the wastewater catchments and their associated below-ground assets started to gain traction in interest surrounding their control as an overall interconnected system. Whilst the above-ground treatment plants have moved

steadily forward with the developing technologies, the wastewater networks were not usually considered until there was an event, such as a burst or pollution event.

Almost all sewerage systems within the UK have little or no dynamic control of the flow through them, and no facilities for warning of service failure before it has impacted customers or the environment [30]. With stricter regulatory compliances from The Water Services Regulation Authority (OFWAT), and a far more customer-focused business model, the waste networks and their control strategies will need an increase in focus as to how the company operates them.

The regulations governing the UK water companies' performance are becoming increasingly more demanding across several target areas, including consented discharge and energy usage. These stricter rules are increasing the driver for adopting a more proactive management of the wastewater catchment and their networks. These will also consider the following:

- Regulation is moving away from an output focussed system where companies are monitored on what they do, to an outcome focussed system where they are monitored on what they achieve.
- Customer satisfaction is now a key measurement of company performance and is used to provide a financial incentives to companies [30].

For ASC to be utilised effectively the control systems require data in the form of inputs and outputs (I/O). Input data comes from sensors within the field, updating the status of the plant / networks. This will include well levels, and pump statuses (including running, availability and failed conditions). Forecast weather data from the MET Office may also be a form of sensory input data that a new feed-forward control system needs to process. Outputs come in the form of control execution commands. At a basic level, these might include start / stop to pump commands or open / close / trim valves commands. At a more holistic level, a control output might be the decision to place a wastewater catchment into an alternate control profile that enables additional capacity within the network by pumping down beyond the normal level.

Until recently, the data were very low resolution, with the telemetry systems used for collection utilising older, physical computer resources. Recent developments within the virtualisation of computing technology and an increase in the availability of more powerful processors have liberated a more flexible approach to managing the telemetry systems. Benefits of creating virtual machines include better exploitation of

powerful resources and the isolation of applications to prevent cross-corruption and improve security [31].

Improving the quality of the performance data gives rise to an understanding of multiple metrics and allows companies to develop reliable models that address application needs. One of these applications includes targeting the points in which energy inefficiencies exist. Thames Water Utilities Ltd have identified this need for data improvement and, since 2010, have been actively engaged in investment to upgrade their operational technology systems, including SCADA platforms (explored in detail in Chapter 4) and the field-based remote telemetry units (RTU). This has led to the replacement of multiple sewage pumping station RTU outstations. These outstations provide greater data efficacy via increased data capture and improved communications protocols using always-connected digital subscriber lines (DSL), as opposed to public switched telephone networks (PSTN). This effectively enables the company to collect data in near real-time. It also enables an option for secure remote control from the regional telemetry (also referred to as the Master-Station or Top-End). This enhanced modern telemetry infrastructure will assist in the deployment following a successful outcome of the research presented.

## ***2.5 Innovative Optimisation Strategies – a literature review***

ASC can be utilised through a range of methodologies and designs. Some will use very basic binary control strategies, to a slightly more advanced control using integer / floating point data types including proportional, integral and derivative (PID) controllers. At the other end of the complexity spectrum, artificial intelligence (AI), a complex information structure system with multi-level system attributes is now a widely available option for controlling a process and offers the means for systems to learn and thus, react dynamically to non-linear stochastic process variables [32]. When considering a wastewater sewer catchment in its mathematically modelled form (and considering that, at present any future rainfall data is not a variable integrated within the incumbent control algorithms), this presents a multi-dimensional design space in which the behaviour of the input variables creates a dynamic non-linear stochastic process.

As the water companies increase their data posture with increasing volume, velocity and variety, 'big data' becomes an integral part of the digital operation. Big data are very large complex data sets, especially when taken from newer sources. These data sets are so voluminous that traditional processing software can no longer manage them. However, there are now the tools that allow these massive volumes of data to

be used to solve business optimisation problems. The advances in big data implementation using sensors, networks and machine learning with the data related to environment, aid water system control prediction models [33].

### 2.5.1 Fuzzy Systems for Optimisation

Fuzzy systems are constructed on linguistic, imprecise methods to describe complex systems [34]. Input variables, such as wet well level, are split into sets; these sets can overlap. The sets form a membership function, with each of these functions imitating a linguistic approach used to describe an everyday condition (e.g., wet well high, low, normal). The rule set is then based on logical reasoning, which employs linguistic rules such as IF statements ( i.e., IF <Variable equals> THEN <Start Control>) [35].

An example of membership functions and their overlap is show in Figure 2-1.

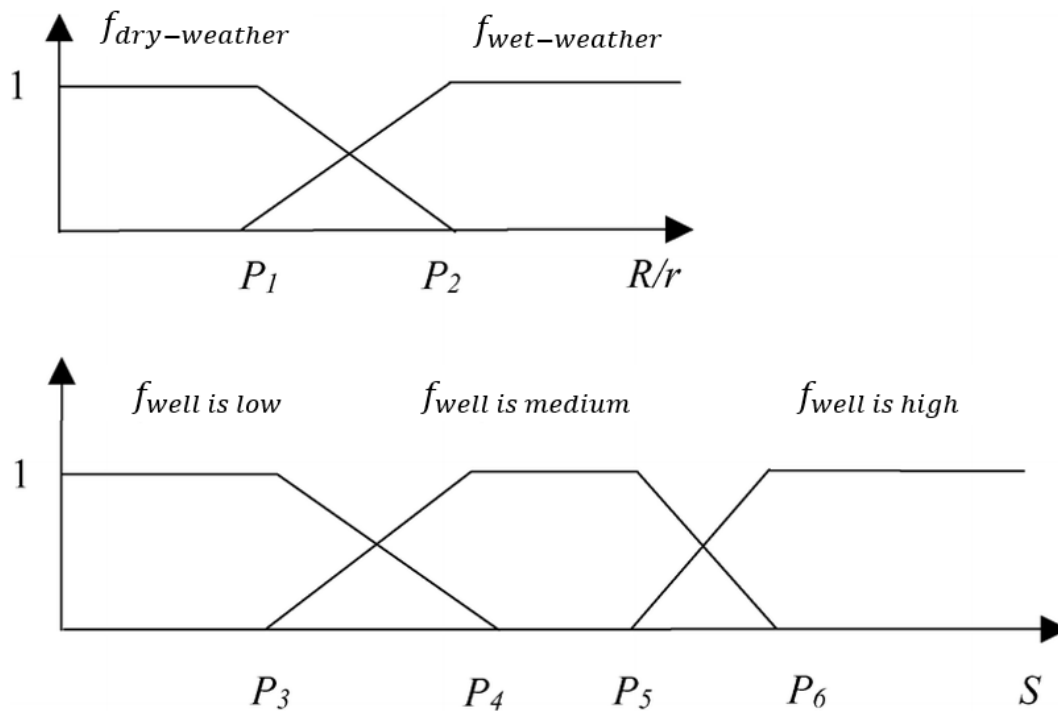

**Figure 2-1 Membership function for the chosen variables adapted from Kissi, Ramdani [36]**

As it can be seen, there are two variables under inspection.

- Is the function 'dry-weather' or 'wet-weather'
- Is the function wet well 'low', 'medium' or 'high'

From here, example fuzzy rules ( $Fuzzy - Rule_n$ ) can be set.

*Fuzzy – Rule<sub>1</sub>*: If weather is dry and wet well is low then optimised pumping ok

*Fuzzy – Rule<sub>2</sub>*: If weather is dry and wet well is high then optimised pumping not ok

*Fuzzy – Rule<sub>3</sub>*: If weather is wet and wet well is high then optimised pumping not ok

The limit values in a standard Fuzzy arrangement, and denoted by  $P_n$ , are identified by discussions with experts [36].

Arslan and Kaya [35] describe that on its own, a Fuzzy system needs input from experts to be able to create the shape of any particular membership function, as it will usually require knowledge of the target application. These membership functions are most often assumed to be linear and triangular in shape. Therefore, the sets that describe various application factors, their importance and any deterministic issues are the parameters that define the triangles. Parameters are usually formed via a control engineer's experience.

To overcome the need for an expert and the required investment / time this might require, the employment of a genetic algorithm (GA) can be adopted. Following a review of [37-39], the research can present an understanding of GA's as techniques for random search and which have been successful in solving problems across a variety of engineering challenges. Further research completed by Karr [40] found that a GA could be employed to determine the membership functions in designing a fuzzy controller.

The development of an autonomous fuzzy logic controller for the deployment within a wastewater catchment was undertaken in a collaboration between Anglian Water and the University of Sheffield.

Ostojin, Mounce [41] presented real-time field validation of a previously AI-based sewer pump control system, which included energy tariffs (current at the time of writing) and pump efficiencies. The fuzzy membership functions were predetermined in shape and number, with their positions optimised via genetic algorithms, thus eliminating the need for expert intervention in an off-line learning environment.

In a separate report by Ostojin, Mounce [42], the study took the existing sewage pumping station wet well level and via an analogue to digital converter, inputted it to a fuzzy inference system (FIS). The FIS then presented an output in the form of a pump start / stop signal.

Figure 2-2 was constructed from research data taken from the trials performed by Ostojin, Mounce [42]. From the data review and the conclusions presented, the fuzzy logic controller appears to have reduced the total running time for both pumps and therefore has further reduced the operational costs.

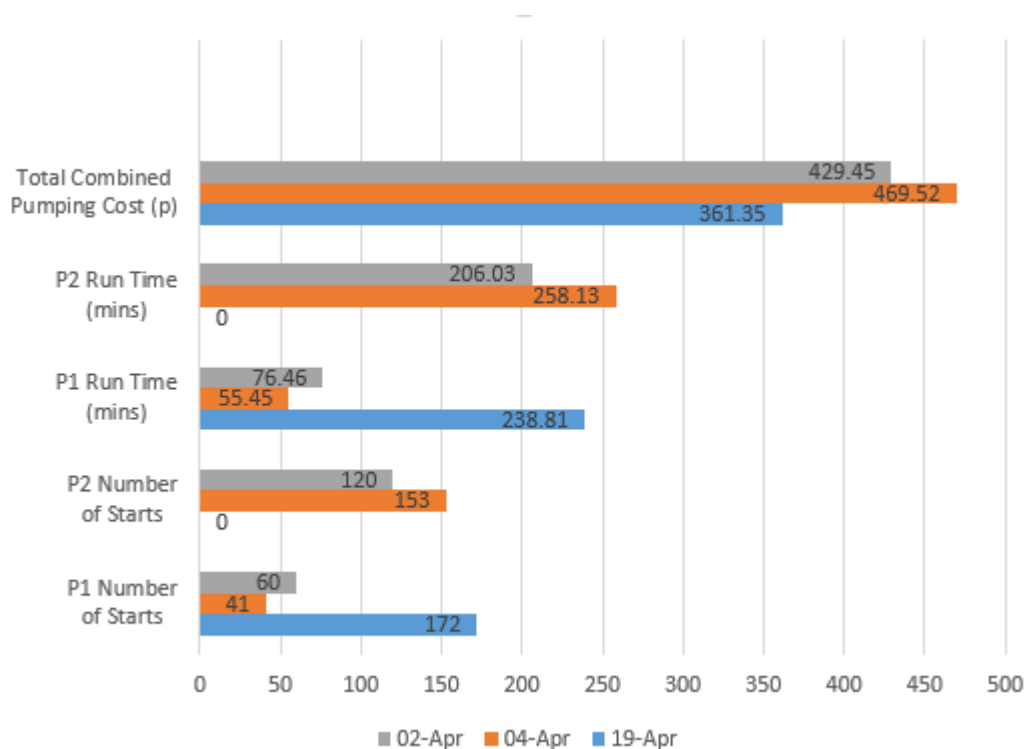

**Figure 2-2 Membership function for the chosen variables adapted from [42]**

A further observation of the current research finds that from the above data the fuzzy system apparently favoured pump 1 for all operational duties. This will inevitably increase the number of start / stop operations for this device, which is not the best use of pumping resources as it will ultimately lead to only one pump unit performing all duty switching. This is likely to seriously reduce the unit's intended operational user life. Further, although the secondary pump may not be operated as frequently, this too can create issues as degradation of the unit through lack of exercise, which leads to seizures becoming a more likely concern. With a large rainfall run-off event, the system could be exposed to potential pollution events.

In the author's opinion, this trial was limited by the fact that it only covered two-days' operation, which does not capture the full spectrum of possible operational patterns and transients. It also did not focus on the overall catchment as an interconnected system and only took the data from a single pumping station. It was, however, of particular interest as it focused on the energy output of the pumps and proved that

through the use of optimisation strategies and techniques, energy consumption could be reduced within a wastewater pumping system.

### *2.5.2 Artificial Neural Networks for Optimisation*

Within many of the leading UK water utility companies, hydraulic modelling software is employed for simulations of real-world scenarios. One such package is the Innovyze product Infoworks™ CS. Artificial neural networks (ANNs) have been trialled within wastewater catchments with some success, as discussed in a collection of UK Water Industry Research (UKWIR) papers. [30, 43-46].

One of the primary drivers for employing ANNs within the water industry comes from the significant potential reduction in overheads (computational, time and cost) that a standard hydraulic model requires. This is based on the fact that these models are complete software replicas of an entire physical water system (e.g., an interconnected sewer system and all pumping station assets) and therefore, require significant levels of time and effort for construction and ongoing maintenance, as the physical systems continue to change as a result of expansion.

Each replica model needs to be constructed as accurately as possible, inclusive of all pipes, nodes, pumps, dimensions, design constants and so forth. Subsequently, they will always require regular maintenance and updates. For example, a catchment that was built five years ago may not be current to today's actual sewer loading due to developments and additional connections to the trunk mains.

What the ANN has been suggested to offer is the omission of all these construction and maintenance overheads. By considering that hydraulic models are used to forecast events based on rainfall data provided by the Meteorological Office (MET Office) radar (which is a form of data input) and then predict when and where a flood event may occur (a form of data output), then the suggestion is made that the complex hydraulic model could be simplified and considered as a transfer function [44].

There are challenges in that the transfer function would not be a simple deterministic algorithm, the inputs it receives are stochastic in nature, and there are multiple outputs, each with varying degrees of magnitude. As a result, this will require a more advanced computational method [30].

As per the aforementioned collection of UKWIR projects, which trialled various techniques of ANN application as a way to predict events without the use of large



hydraulic models, the individual projects all had varying angles of exploration. The project authored by Smith [43] focused on three catchments, the largest of which was London's Crossness catchment. The Crossness catchment drains a region of South London at a capacity of 9m<sup>3</sup>/s and delivers it to the Crossness wastewater treatment facility located in the borough of Bexley Heath. The modelling was split into two stages:

- Stage 1: Run the ANN model 16 times using a flood estimation handbook (FEH) comprising synthetic design rainfall.
- Stage 2: Take historical spatial rainfall data provided by Thames Water Utilities Ltd and iterate the model 50 times with a varying degree in the data.

Rules were determined for which data sets would be used for training the ANN model and which would be used for testing.

The data was collected and analysed using the Nash Sutcliffe Efficiency Coefficient (NSEC). NSEC has received considerable attention in hydraulic modelling and is a dimensionless evaluation index. The NSEC tends to reflect the characteristics of wet periods or flood seasons sensitively and although certain limitations exist, it is still considered to be the best objective function and is widely used in the calibration and verification of different hydrological models [47]. The NSECs were plotted on box and whisker charts and target hydrographs.

Figure 2-3 and Figure 2-4 are from one of the poorer ANN predictions. As is shown in the NSEC plot in Figure 2-3, the 2nd and 3rd quartiles spread almost evenly across zero. For the prediction to be considered a success, the box plot would need to be nearer the 0.85 area, with nothing below 0.5.

Figure 2-4 shows that although the time in which the ANN predicted the flood occurrence was very accurate when correlated against the data, the issue came with the prediction of flood volume and the location (the manhole) where the event occurred.

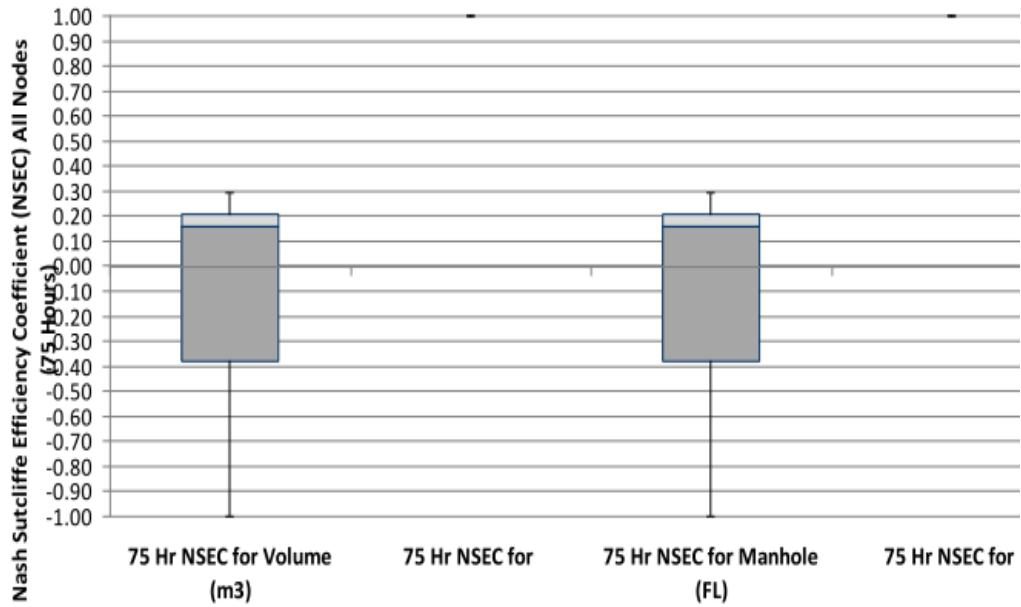

Figure 2-3 Box and whisker plot output for flooding prediction [43]

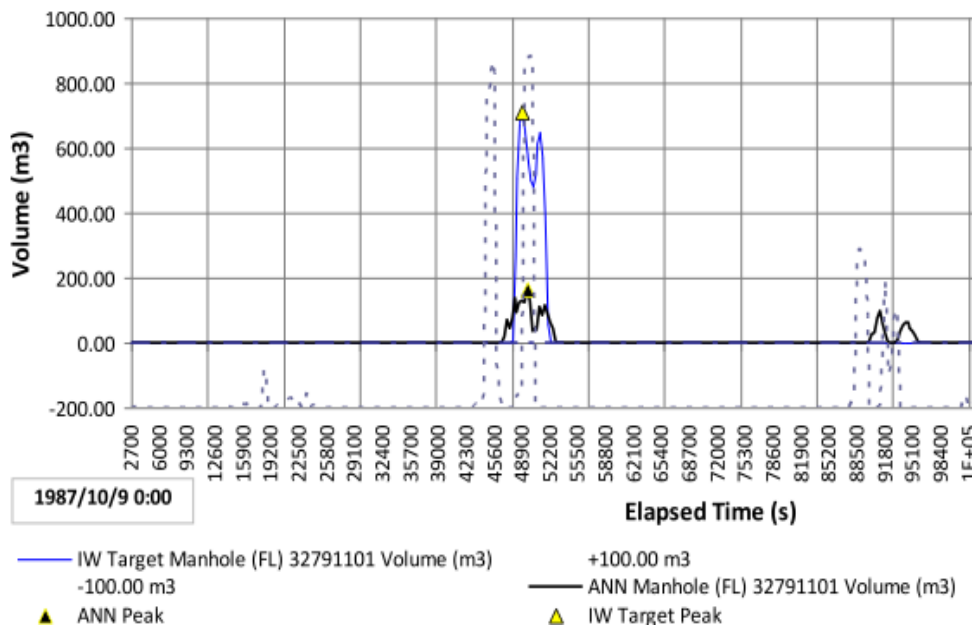
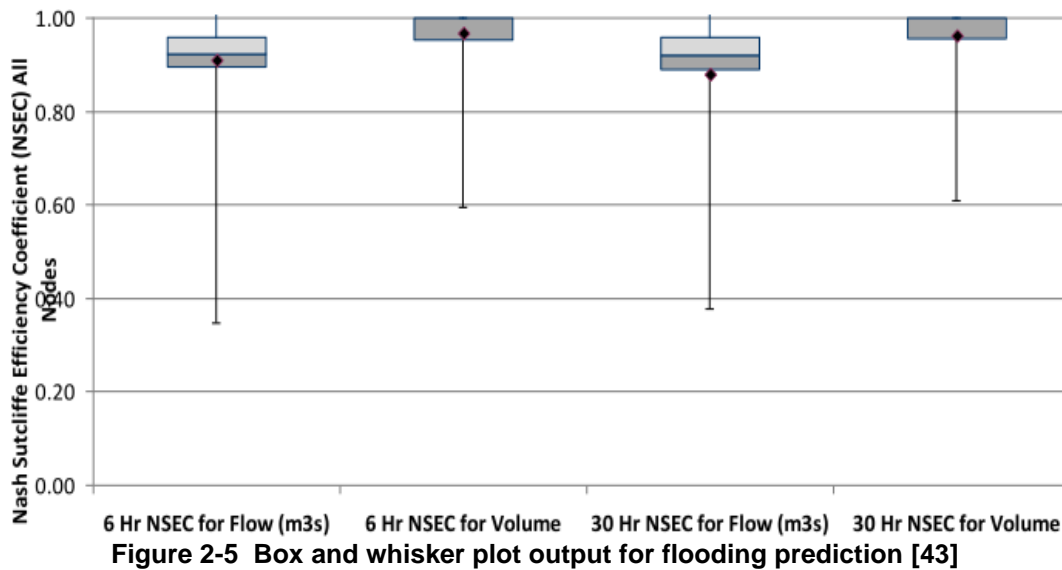

Figure 2-4 Hydrograph for flooding prediction [43]

Figure 2-5 is from one of the better ANN predictions; the NSEC box and whisker plot shows the 2nd and 3rd quartile packed tightly together and all well above 0.8.



The conclusions found by Smith [43] reported, but were not limited to, the following:

The size of the Crossness catchment, including the input data of 23 rain-gauges within the model, led to a relatively ambitious step, which further resulted in some very poor predictions. If the scope had been revised and the ANN was applied to smaller catchments, or if the Crossness catchment was split into smaller sub-catchments, then the results could have been closer in predictions that correlated with the hydraulic model. The positive result from the ANN was the time prediction, with almost all event runs predicting the time in which the event occurred.

The current research concludes that there are other potential benefits when using ANN models in sewerage management. These include potential reduction in pumping costs, better operation of wastewater treatment and further identification of incipient blockages in the sewerage system (although these were not demonstrated in the UKWIR project).

### 2.5.3 Optimisation using the Tynemarch Systems MISER-PSL

Tynemarch Systems are a UK-based company that deliver software modelling packages. One of which is MISER-PSL, which routinely derives demand forecasts, pump and valve schedules and optimal reservoir profiles. It does this by utilising a connection to a water company's telemetry platform to obtain live data.

From review of the research to date on MISER-PSL, it is understood that the focus is primarily on clean water applications only. However, based upon the characteristics associated with a piped and pumped network, it has been reviewed by the author as a potential option for the application of wastewater optimisation.

MISER-PSL looks at demand modelling by cross correlating pump flow / power values against current tariffs. Pump Scheduling is achieved by an optimisation process that is autonomous in the priming of the current historical abstraction license usage, most frequent current conditions and the consumer demands forecast [48].

[48] advise that demand forecasting models can be configured for each demand zone to predict short-term demand based on live telemetry data. This is typically for a 24 to 48-hour forecast horizon, but potentially up to 7 days ahead in order, for example, to take advantage of weekday / weekend variations in electricity tariffs or for outage planning in the forthcoming week. This technology, therefore, has the potential to be utilised in modelling the hydraulic behaviours of waste networks and provide schedules so that the optimisation of the pumping systems is achieved. Anglian Water have since completed a study on the Tynemarch MISER product based on the offerings as follows:

- Reduced operational expenditure (Opex) via a reduction of energy consumption, 5-10% per annum [2].
- Provision of valuable decision-support tooling for use within a water control room.
- Proactive demand forecasting.
- Identification of operational responses to unplanned outages.

From a review of the report presented by [2], the research discusses the following summary. The Anglian and MISER trial was deployed across two phases. The first phase saw the MISER system access an offline model only. As a result of being offline, there was additional effort required to keep the system up to date with pump scheduling; this was required twice a day. Phase two saw the Anglian Water operations control room fully adopt the MISER system. This took a semi-automated feed direct from the telemetry system. In turn, it then generated revised pump schedules, which were manually applied by operations. Accuracies were evaluated by comparing the MISER forecasted demand versus the actual data recorded in the telemetry system. Figure 2-6 shows a highly accurate forecast trend when compared to the actual data taken from the telemetry system



**Figure 2-6 Anglian Water and Tynemarch – Demand Correlation 1 [2]**

However, Figure 2-7 **Error! Reference source not found.** shows areas where the predictions do not match the actual demand with any degree of accuracy.

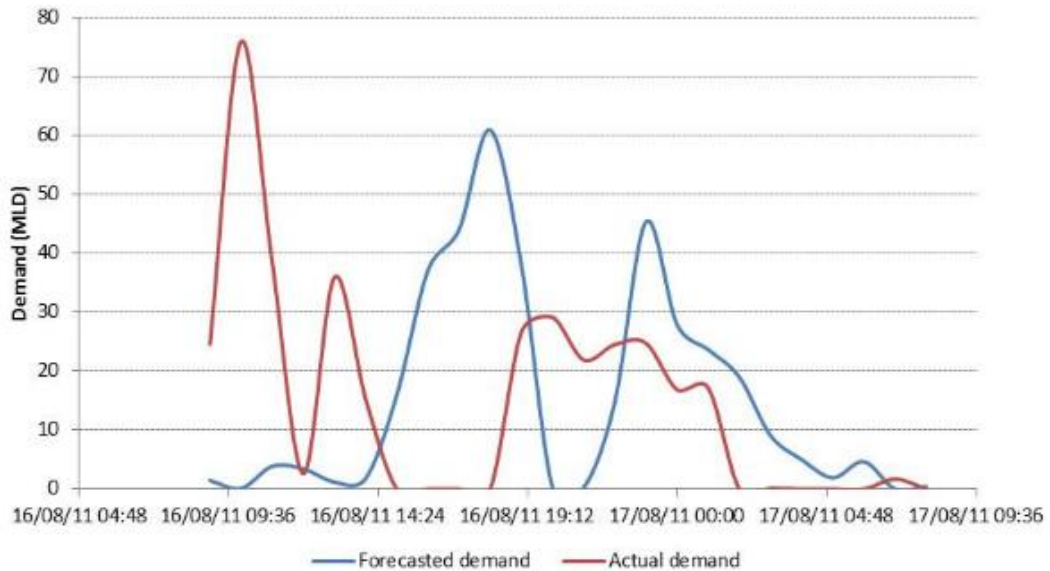

**Figure 2-7 Anglian Water and Tynemarch – Demand Correlation 2 [2]**

The report's conclusions stated that the forecast demand data was found to be highly area specific, with some areas demonstrating extremely high correlation coefficients (in the range of 0.97) but some showing very poor correlation. The larger deviations were noted across areas with greater unpredictability of water abstraction and those at the boundary of the model rather than within the design space of the model.

The original interest from the current research and this system was that there did not appear to be a direct link between the demand forecasting and the process automation systems; the control room were still required to implement the pump schedules manually. What this could have unlocked was a unique concept on the integration of the MISER system within the existing Thames Water Utilities Ltd telemetry infrastructure. The further intention is to autonomously set certain profile conditions for pump scheduling with a wastewater catchment. For example, when risk is minimal in low flow conditions, set pump start commands at higher levels and pump the well down further, thus reducing pump starts and prolonging asset life.

Due to the MISER system being applied on water systems only due to some large variances within the correlation coefficients, it was decided that this option would not be progressed; however, one of the fundamental learning outcomes was taken, and that was to ensure a full offline trial is completed on whatever the chosen optimisation strategy is before deployment to a production environment.

#### *2.5.4 EPANET*

The United States Environmental Protection Agency provides a software package called EPANET [49]. This is public-domain software that can be freely copied and distributed. Its primary purpose, much like the Tynemarch MISER system, is for the modelling of clean water distribution piping systems. EPANET performs an extended period simulation of the water movement and quality behaviour within pressurised piped networks. These networks are built with pipes, nodes (junctions), pumps, valves, and storage tanks or reservoirs. EPANET can be utilised to assemble representative networks that track the following:

- Flow of water in each pipe.
- Pressure at each node.
- Height of the water in each tank.

Although the EPANET system is primarily used for clean water distribution networks and focuses on pressurised networks, the C++ programming language is open source, therefore, users can modify the application to suit personal requirements. Thus, the application could be modified and manipulated to process data from wastewater systems, with an objective function targeting the reduction of electrical energy in the catchment. Further analysis of the offerings from the package by the [49] suggests that

it provides a fully equipped, extended-period hydraulic analysis package that, in turn, can:

- Simulate systems of any size.
- Compute friction head loss using the Hazen-Williams, the Darcy Weisbach, or the Chezy-Manning formula [50].
- Include minor head losses for bends, fittings, etc.
- Model constant or variable speed pumps.
- Compute pumping energy and cost.
- Model the movement of a non-reactive tracer material throughout the network over time.
- Track the percentage of flow from a given node reaching all other nodes over time.
- Employ global reaction rate coefficients that can be modified on a pipe-by-pipe basis.
- Allow for time-varying concentration or mass inputs at any location in the network.

A case study presented by the literature below is a hypothetical example taken from [50] and expanded upon by [51]. It comprises a very simple network with one supply reservoir, eight nodes (demand points) and ten interconnecting pipes, as shown in Figure 2-8.

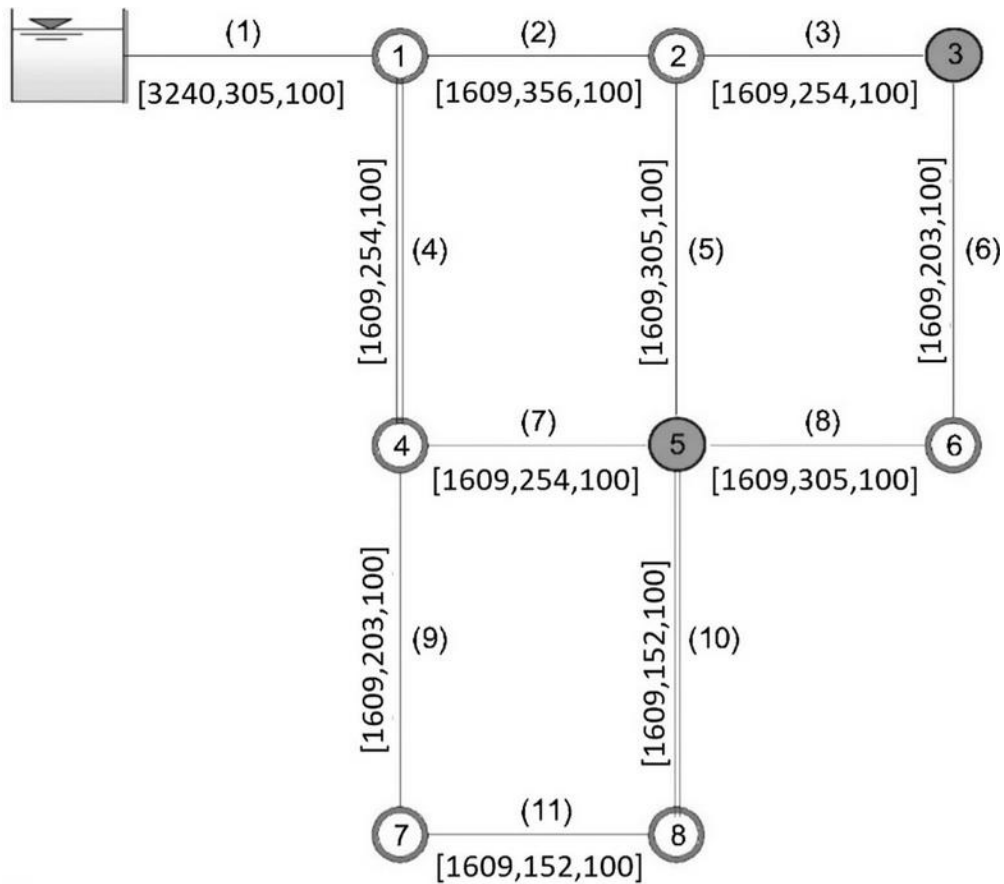

**Figure 2-8 EPANET Case Study Schematic Network [51]**

Key for Figure 2-8 above:

- ( ) Pipe numbering
- [length(m), diameter(mm), roughness]
- Circle = Node (if coloured grey, it is metered)
- Line = Pipe (if the line is doubled, it is metered)

As part of the modelling, pressure output is measured at two nodes and flow output is measured at two pipes. These are observed values and are assumed to have zero measurement error. The results are presented in Table 2-2.

**Table 2-2 Case Study Observed Results taken from [51]**

Sensor Location	Variable	Observed Value	PD 1	PD 2
Node 3	Pressure (m)	44.20	44.20	44.20
Node 5	Pressure (m)	44.10	44.10	44.10
Pipe 4	Flow (l/s)	20.81	20.32	20.32
Pipe 10	Flow (l/s)	4.35	4.35	4.35

The observed values were then combined with some previous water demands (PD1 and PD2 respectively) and used to estimate the current node demands. Both PD1 and



PD2 were randomly generated for the same total demand. The mean node demands for PD1 and PD2 are shown in Table 2-3.

**Table 2-3 Case Study Observed Results taken from [51]**

Node	PD1			PD2		
	Prior consumer demand (l/s)	Estimated consumer demand (l/s)	Deviation from prior consumer demand (%)	Prior consumer demand (l/s)	Estimated consumer demand (l/s)	Deviation from prior consumer demand (%)
1	9.46	10.22	8.03	8.83	9.96	12.80
2	9.46	9.51	0.53	10.09	9.95	1.39
3	6.31	6.18	2.06	6.94	6.16	11.24
4	9.46	9.24	2.33	8.83	8.76	0.79
5	12.62	12.89	2.14	13.25	13.38	0.98
6	9.46	8.90	5.92	8.83	8.38	5.10
7	6.94	6.21	10.52	6.94	6.78	2.31
8	6.31	6.36	0.79	5.68	6.10	7.39

[51] conclude that from the data presented, the deviations between observed value and estimated value offer a satisfactory minimal deviation and prove a stable calibration. One observation suggests that although the total water demand is the same, the designed PD1 and PD2 have different nodal demand allocations. The literature further suggests this could result from data issues within a few of the field measurements and thus calibration errors.

The current research has investigated the EPANET software package based on the flexibility it offers, along with the positive results yielded from the aforementioned case study. This could permit modifications that accurately model and control a wastewater catchment. Further, it could be integrated using an application programming interface (API) with direct links into a water company's SCADA system that subsequently executes control to the catchment.

At the time of writing, the research concludes that based upon the comments made by [51] regarding the importance of suitably calibrated field instrumentation, along with the fact that a UK wastewater catchment lacks instrumentation across the network when compared to a clean water system, then the use of EPANET would require a huge level of investment in order to provide the sensory field data to drive any satisfactory results.

The use of EPANET as an option for model optimisation and catchment control should not be discounted and should be used by future research and investment projects in

providing a positive benefits case for improved instrumentation across a wastewater catchment.

From a review of the EPANET research presented, the current research concludes on the importance of calibration from any incumbent instrumentation and reporting systems. Namely, in the case of wastewater systems, any telemetry data that exists and pertains to the state of the target catchment.

#### *2.5.5 Ant Colony Optimisation*

[52] describe Ant Colony Optimisation (ACO) as a meta-heuristic, which is a form of strategy that guides a search process. It is a problem-independent optimisation technique that has been successfully applied to several design problems.

The original concept behind ant colony optimisation was taken from the study of the foraging behaviour of live ants. While ants wander through unexplored areas, they choose their path randomly. Where available, they will also follow the paths marked by pheromones left by other ants, stochastically choosing with a higher probability those paths marked with a higher amount of pheromone [53]. The path chosen by an ant is further reinforced by its own pheromone trail as it walks along the path, further increasing the probability of other ants following the same path. Successive reinforcement of the pheromone trails results in a positive feedback mechanism [52].

These mechanisms have been mathematically modelled and applied to pump scheduling and optimisation processes within clean water systems. Some positive results have been achieved by Lopez-Ibanez, particularly in their models utilising the EPANET software packages. The research has further found that ACO is well represented in the literature regarding the tuning of Fuzzy controllers and has been well presented by [54-56], all offering good optimisation results. In addition, [57] used ACO to solve an optimisation problem on the sizing of pipes within a clean water distribution system, resulting in a cost reduction for asset (pipe) sizing.

The research finds limited literature on the use of ACO in wastewater optimisation applications. [53] present the use of ACO as a metaheuristic for solving a cost optimisation problem for stormwater system design. In this project, the delivery of a new stormwater catchment is tackled in the form of the travelling salesman problem, which is a typical example of how ACO can be used to solve design problems using metaheuristics and discussed by [1]. For example, a delivery truck starting at location

$p_1$  in Figure 2-9 must visit three locations to deliver a distinct piece of cargo at each location. The objective is to find a minimum time route [58].

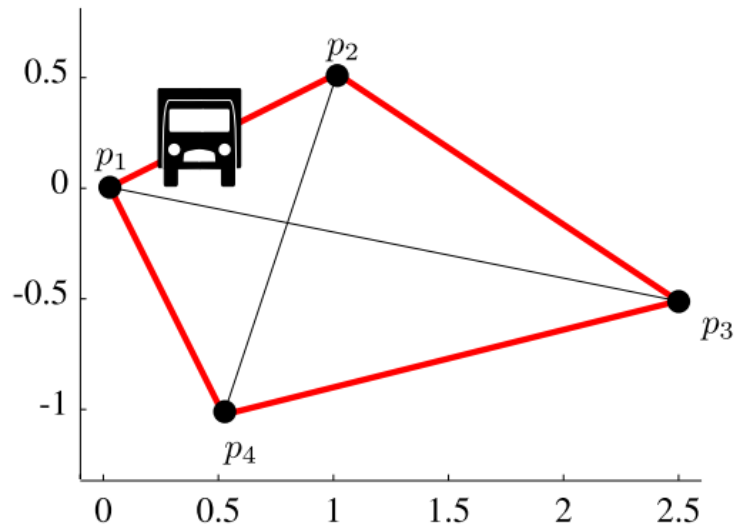

**Figure 2-9 Travelling Sales Man Example [1]**

The research by [53] concludes with a reduction in the required asset investment to solve the same volumetric output of the initial non-optimised system design.

#### **2.5.5.1 Theoretical ACO Application**

Considering the ACO modelling used for optimising the cost of asset installation, as presented by [57], the ‘virtual ant’ denoted by  $k$  will follow a pre-set number of pipeline options. It will do this one-by-one in search of the optimal pipeline. In this case, the optimal pipeline is the one that satisfies all constraints, such as flow and pressure limits but also meets the objective, which is to select the smallest diameter pipe and therefore reduce capital investment.

The search begins with each pipe being assigned a pheromone  $\tau$ . When the virtual ant is in the pipeline for review  $i$  it uses the pheromones to calculate the probability of selecting the optimal pipe diameter  $j$ .

$$P_{ij}^k = \frac{[\tau_{ij}]^\alpha [\eta_{ij}]^\beta}{\sum_{l \in N} [\tau_{il}]^\alpha [\eta_{il}]^\beta} \quad (2.1)$$

Where:

- $P_{ij}^k$  = the probability of selecting pipeline diameter  $j$  for the pipe in review  $i$
- $N$  = the range in value of available pipe diameters
- $\tau_{ij}$  = is the intensity of the pheromone trail between pipe  $i$  and diameter  $j$
- $\eta_{ij}$  = best fit of diameter  $j$  for pipe  $i$  based on constraints and target objective
- $\alpha$  = a parameter that regulates the influence of the pheromone  $\tau_{ij}$  (usually between 0 and 1)
- $\beta$  = a parameter that regulates the influence of the pheromone  $\eta_{ij}$  (usually between 0 and 1)

In order to prevent the virtual ant from tending to a local optimum prematurely a pheromone evaporation mechanism is set and denoted as.

$$\tau_{ij}(t+1) = \rho \cdot \tau_{ij}(t) + \Delta\tau_{ij} \quad (2.2)$$

Where: 
$$\Delta_{\tau_{ij}} = \sum_{k=1}^n \Delta\tau_{ij}^k \quad (2.3)$$

And 
$$\Delta\tau_{ij}^k = \frac{Q}{C^k} \quad (2.4)$$

- $\rho \in [0, 1]$  and is the evaporation factor and which regulates the reduction of the pheromone.
- $C^k$  represents the fitness function obtained by the solution of sizing the diameter to the pipe as established by the virtual ant.
- $Q$  is the increase in strength factor of the pheromone

By considering the above model, the application of ACO could be applied to the optimisation of a wastewater pumping system as follows:

The ‘virtual ant’ denoted by  $k$  will follow a pre-set number of pump starts within a wet-well. It will do this one-by-one in search of the optimal start level. In this case, the optimal start level is the one that satisfies the constraints of no pollutions within the catchment, or having the start level breach the physical dimensions of the well, but also meets the objective, which is to reduce energy by further reducing the amount of time a pump is running.

The search begins with each pump start level being assigned a pheromone  $\tau$ . When the virtual ant is in the wet-well for review  $W$  it uses the pheromones to calculate the probability of selecting the optimal start level  $S$ .

$$P_{ws}^k = \frac{[\tau_{ws}]^\alpha [\eta_{ws}]^\beta}{\sum_{l \in N} [\tau_{ws}]^\alpha [\eta_{ws}]^\beta} \quad (2.5)$$

Where:

- $P_{ws}^k$  = the probability of selecting the optimal start level  $S$  for the wet-well in review  $W$
- $N$  = the range in value of available pipe start levels
- $\tau_{ws}$  = is the intensity of the pheromone trail between wet-well  $W$  and start level  $S$
- $\eta_{ws}$  = best fit of start level  $S$  for wet-well  $W$  based on constraints and target objective
- $\alpha$  = a parameter that regulates the influence of the pheromone  $\tau_{ws}$  (usually between 0 and 1)
- $\beta$  = a parameter that regulates the influence of the pheromone  $\eta_{ws}$  (usually between 0 and 1)

In order to prevent the virtual ant from tending to a local optimum prematurely the pheromone evaporation mechanism will be set as before and denoted as.

$$\tau_{ws}(t + 1) = \rho \cdot \tau_{ws}(t) + \Delta\tau_{ws} \quad (2.6)$$

Where 
$$\Delta\tau_{ws} = \sum_{k=1}^n \Delta\tau_{ws}^k \quad (2.7)$$

And 
$$\Delta\tau_{ws}^k = \frac{Q}{C^k} \quad (2.8)$$

- $\rho \in [0, 1]$  = the evaporation factor, which regulates the reduction of the pheromone.
- $C^k$  represents the fitness function obtained by the solution of sizing the diameter to the pipe as established by the virtual ant.
- $Q$  is the increase in strength factor of the pheromone

The change in application of the ACO model, which looked to optimise upon a best fit function, in terms of level within a wet-well, and that drives the most efficient energy use, whilst not breaching any environmental constraints appears a feasible, yet unique, option for further exploration within the research.

Initially, the author considered the potential for amalgamation of an ACO algorithm within the Thames Water Utilities Ltd regional SCADA system, so that improved pump scheduling could be achieved autonomously. From a deeper review of the literature, it is further understood that ACO and potentially any other form of metaheuristic optimisation would not be an application that directly controls a pumped system in real-time. Moreover, it is concluded further that this strategy would be better suited to the hydraulic modelling software used for wastewater catchment simulation rather than a direct API to telemetry. Any positive results could then be taken and applied within the wastewater control system.

Further review of the literature concludes limited application of ACO for the real-time control of wastewater pumping systems but considers that by using metaheuristics and focusing on electrical energy as the objective function, there are potential options for the deployment and application within the modelling software.

### 2.5.6 *Optimisation success within a high demand water pumping system*

The research interviewed a project engineering team at the large Hampton clean water site in London. [59] gave an update on an optimisation project delivered by BGEN (previously Boulting), a mechanical, electrical, instrumentation control and automation (MEICA) company. The project delivered an intelligent 'Black Box' (a device a user sends inputs to and receives outputs from but does not know what is coded inside [60]) to run pump efficiency software within the incumbent control system.

This involved a system analysis which included pump efficiency monitoring through thermodynamic testing. This is described by [61] as a form of pump testing where only temperature rise, power consumption, and differential pressure need to be measured to find the efficiency of a pump. These measurements are typically made with insertion temperature probes and pressure probes fitted to tapping points on the pump's inlet and outlet.

The need for the project came from the fact that many of the installed pump systems within the company were running significantly below their best performance, as reported to the author by the project manager [59]. The methodology for achieving pump system optimisation and maximum savings, developed between BGEN and Thames Water Utilities Ltd, looked at analysing the system holistically, identifying clear kWh savings and returns on investment (ROI) rather than individual pumping components in isolation.

In order to understand the target system, including any associated inefficiencies, the additional variables were considered as part of the optimisation project.

- Where is the pump, pumping from and to?
- What parameters change during operation?
- Pipeline diameter and pipeline velocities
- Valve arrangement
- Static head variations
- Flow variations
- Reliability and failures
- Specific energy consumption
- Control system architecture and compatibility

The specific BGEN / Thames Water Utilities Ltd project reported favourable results, which were achieved on an interstage pump station. The individual pump discharge pressures were measured, along with the common manifold system pressure and flow. From these parameters, and with some modelling, BGEN developed an algorithm that is deployed within the process areas PLC. The algorithm, based on the target flow rate ensures that the optimum energy efficiency is achieved.

Details on the deployed algorithm are subject to intellectual property rights (IPR) and the author was not able to gain access to the raw code.

From a further non-invasive investigation, the methodology behind the software can be explained as such; there is an eight-pump, two-manifold (four pumps per manifold) system. The discharge of each of the pump sets is delivered to the ozone treatment plant on site. All eight pumps comprise a variable speed drive (VSD). Feedback from the pumps, in the form of floating-point variables, include speed, consumed power, discharge pressure, common manifold pressure and flow rate. These variables are plugged into the black box and are what allow the algorithm to deliver the target flow rate at the optimum energy efficiency.

The research considers it likely that this project has achieved energy efficiency savings by running pumps and, through use of the VSDs and other sensory information, ensured the pump and system curves intersect at the optimal point.

In a parallel pumping configuration, which the Hampton example describes, it is not typical to inspect pump and system curves individually on a per-pump basis. [62] describes the use of composite curves for the representation of the combined performance and resistance of pumps working in parallel. [63] adds that introducing multiple pumps with the intention of delivering more flow, does not always result in the desired net increase. Quite often, the system can approach the point of diminishing returns where more pumps do not generate a proportional flow output, with the overall kW/litre pumped ratio reducing.

Figure 2-10 shows an example of a system curve that is steep in nature.



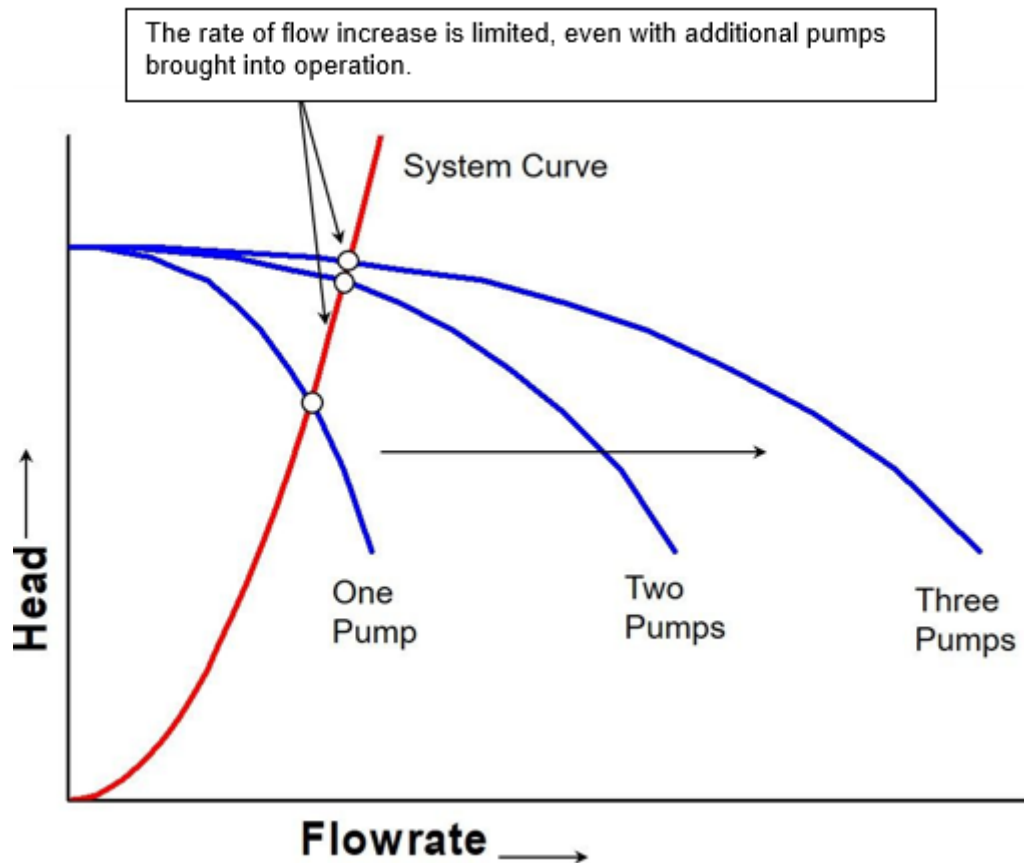

Figure 2-10 Example system curve from frictionally dominated system [63]

As can be seen, the intersect points from each pump suggest very little by way of additional flow output from the second and third pumps. [63] explains that this often is the result of a frictionally dominated system, which is when most of the significant system resistance a pump must work against is from friction within the piped system. Elevation changes are small in comparison when considering these types of system.

Figure 2-11 shows an example of a system curve that is much flatter.

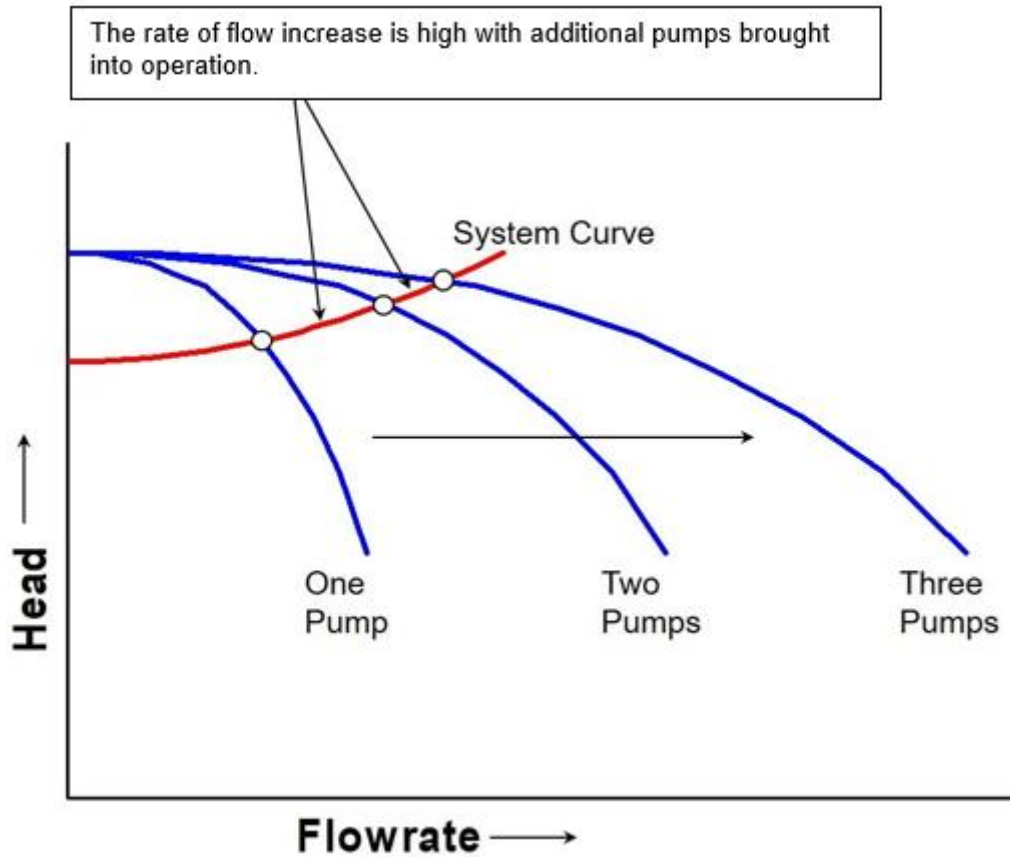

Figure 2-11 Example system curve from static dominated system [63]

With this example, the intersect points from each pump suggest a much higher flow output when bringing in the second and third pumps. Again [63] explains; this is synonymous with a system that is statically dominated and where the primary resistance a pump must overcome is elevation change.

From both examples, there is clear evidence that by bringing on additional pumps on their own, may not solve any additional flow demands. There are optimal points where both system curve and pump curve intersect. The introduction of VSDs give greater flexibility in terms of how a pump can be operated in the hunt for an optimal point on a head / discharge curve.

In contrast, some of the incumbent, legacy, pumping strategies within the company would include running a single-duty pump up to full speed until it could not satisfy the demand any further. At this point, a secondary pump would be called in to assist the duty pump, which would remain running at full speed. If there were more pumps, then the same logic would be applied for however many pumps in the array were required to meet the demand. As per the above, this is deemed an inefficient method, as energy is wasted in targeting the required flow.

By using VSDs and the variable control that integration with a PLC offers, there are options that would enable speed adjustments to be made on a per-pump basis, with the emphasis on ensuring each pump (whether alone or operating in parallel with others) stays close to the optimal point on its curve and the system curve respectively.

The research has concluded that the BGEN algorithm runs all the pumps at varying speeds to ensure the maximum output is achieved via the minimum input and, as such satisfies the energy curve. In addition, the research draws the following conclusions regarding the applicability of this approach when applied to a wastewater catchment.

- Constraints surrounding the use of black-box systems. Although advances in auxiliary technologies are proving that results are possible, the black-box solutions and their unknown complex transfer functions are harder to adopt within an operational production environment. When a black-box solution is deployed, it comes into a production environment with the operators and maintainers having no understanding of the internal workings or transfer functions that reside within. This, in turn impacts the teams, most notably when considering fault diagnosis, as they require a comprehensive understanding of the systems that control their assets, such that fault conditions can be easily diagnosed and the mean time to return to service is kept to an acceptable minimum.
- The aforementioned BGEN trial was conducted on a clean water site, which comprised additional sensor data, including flow, pressure and pump speeds. On these site architectures it is very common for process plant to be fitted with this additional sensory data. On small wastewater pumping stations, however, this is highly unlikely. Upon inspection of the Thames Water Utilities Ltd wastewater telemetry database, it was concluded that the majority (>90%) of pumping station sites comprised only one variable datapoint: the wet well level. From discussions with asset owners, there are very few sites that have a station output flow meter installed, and where one does exist this is usually on the common rising main and is not able to offer an accurate per-pump flow rate. Basic logic is available within some of the telemetry devices that calculate per pump flow based on the common output; however, as per the discussion above the surrounding pump and system curves, and the fact it is not as simple as direct addition, this would not be accurate enough to permit control loop feedback.

- The availability of variable speed controllers on a per-pump basis. This was true for the trial at Hampton and is a common scenario on large process plants; however, as per the instrumentation constraints noted above, the availability of VSDs installed on assets within wastewater pumping stations is not something that has been required historically.
- Frictionally dominated systems. When considering a wastewater pumping system, this usually comprises a long rising main that moves the wastewater over an area of higher ground. As the rising main is long in length, this suggests a frictionally dominated system curve, unlike the statically dominated system at Hampton. As such, the addition of extra pumps and their control may not yield an efficient return.
- When reviewing the Hampton optimisation project, to use its application for the purpose of the target research, a comparative review of a wastewater catchment architecture must consider the following. To match the application, the wastewater catchment must be considered as one collective process area, i.e., every interconnected pumping station forms part of the overall control system. As a result, for the purpose of balancing the system and pump curves, each and every site logic controller would need peer-to-peer control system integration. As the spatial distribution across a catchment can be in the order of several miles, and there are no dedicated local area network (LAN) links between the sites, reliance upon third-party communication providers' infrastructure would be required to integrate the systems. When further considering the availability required for control system networks, which on local site LAN links are in the order of 99.99%, and the commercial agreements that bind a water company with a communications provider, the service level agreement (SLA) needed would either:
  - most likely be unobtainable or,
  - be economically unviable for the return it offered from an optimised wastewater catchment.

## **2.6 Consideration of Additional Influencing Factors**

### *2.6.1 Data for modelling*

For modelling any required variables from the incumbent technology stack, the routes the data take from source to analysis comprise a mixture of old and new products. These technologies are installed sporadically and via many different delivery

mechanisms. As a result, a fully holistic end-to-end comprehension of the interfacing / configuration requirements is sometimes lacking.

Other issues include data access and bandwidth limitations. Before the optimisation of any target wastewater catchment can take place, an understanding of how to address these issues is required. Understanding this will assist the research in quantifying any additional capital investment needed to deliver a successful, fully productionised outcome.

Part of the research will investigate the data journey, with particular emphasis being placed on energy data from an existing telemetry system. Consideration for any new upgrade being delivered and how to improve the data journey will also be reviewed. Better data availability and quality will only help develop an improved model that reduces energy consumption within a wastewater network.

At the time of writing, Thames Water Utilities Ltd currently operate a regional SCADA system, to serve their operations control centre. This connects to and receives process data (in some cases, sends control commands) from the operational sites and their assets. These databases are deployed across three computational resource structures. Two provide clean water services, and the other provides the service for all wastewater assets and will be the only system the research considers.

The wastewater database captures and stores process data from the remote assets. The data are stored within local proprietary historian servers before being propagated onto auxiliary tier 2 historians. This spans the full wastewater asset landscape, from remote pumping stations that collect and distribute low levels of combined sewage overflow (CSO) to the largest treatment works such as Beckton sewage treatment works, which currently treats the wastewater of 3.5million people.

### *2.6.2 Enhanced Pump Station Controller*

The Multitrode Multismart, is a modern intelligent remote telemetry unit (RTU) that, in recent times, has been used to replace many of the previous legacy RTUs across the pumping station estate. It utilises the IEC 61131-3 open international standard for programmable logic controllers, which deals with basic software architecture and programming languages of the control software deployed within a PLC [64]. It defines three graphical and two textual programming language standards.

- Ladder, graphical

- Function block diagram (FBD), graphical
- Structured text (ST), textual
- Instruction list (IL), textual
- Sequential function chart (SFC), graphical.

Within the company's operation and maintenance resource pools for instrumentation, control and automation (ICA), the technicians are very familiar with this language standard. They are most conversant with the graphical ladder and function block languages.

The Multismart uses an IEC 61131-3 product called ISaGRAF. This enables programming for the unit's onsite computational control. ISaGRAF is a highly flexible platform that will integrate with C++ and, as such, could offer the research further integration options [65].

At the time of writing, the installations of the new Multitrode units have been split into two architectures.

- Enhanced Pumping Station Management (EPSM) sites.
- Telemetry Enhancement Package (TEP) sites.

As a result of the aforementioned research objectives, which intend to provide an optimisation that can be deployed into a production environment, much focus will be aimed primarily at sites already on an EPSM architecture. This is because the EPSM architectures have been installed with a broader scale of performance data, as well as the ability to control the pump start / stop levels from within the unit. Focussing on pre-existing EPSM sites should reduce any additional capital investment required for future rollout of a solution, as the sites are already equipped for remote control.

The deployment of TEP sites only focussed on plant critical data, with the ability to remotely reset the pump being the only control command installed. As a result, there is no scope for controlling the pump start / stop levels from a TEP at this stage. In addition, the data available for modelling at each of the EPSM sites includes, output flow, pump running electrical currents, supply voltage and frequency. It is hoped that this will enable energy analysis to further identify the optimum scheduling of the individual assets.

### *2.6.3 Networks and Hydraulic Capacity*

The networks and hydraulic modelling teams at Thames will play a pivotal role in the selection of the trial catchment. Once the sites with active EPSM RTUs have been determined and verified as good sources of data, then the research will target the networks and their associated hydraulic characteristics which the data represent.

The cross-modelling between the network characteristics and the data received back from the RTUs will assist in identifying areas of network capacity that can be exploited.

### *2.6.4 Balancing Services*

The National Grid Electricity Transmission (NGET), colloquially known as National Grid, state that electricity cannot yet be stored on a large scale, and so one of the key roles is to balance the demand and supply of electricity on a per second basis [66].

One initiative achieves this through the purchasing of balancing services. Typically, balancing services will include back-up generation and / or load reduction, offering further efficiencies and potential revenue streams for large industrial operators and their assets.

Short-term operating reserve (STOR) is an incentive scheme that appeals to large demand-side users, especially utilities. At the time of writing, the incentives for STOR operators were as those shown in Table 2-4.

**Table 2-4 STOR - Technical requirements [67]**

<b>Service Name</b>	<b>Min Service Size</b>	<b>Max Notice Period before service delivered</b>	<b>Time limits around service delivery</b>	<b>Typical Payment</b>
Short Term Operating Reserve (STOR)	3MW (Smaller sites can be aggregated into a 3MW load)	240min	Must be able to sustain delivery for minimum of 120min if required	£40,000 (per MW per year)
Fast Reserve	50MW	2min	Must be able to sustain delivery for minimum of 15min if required	£50,000 (per MW per year)
Frequency Response	3MW	<2sec	Able to sustain up to 30min if required	£56,000 (per MW per year)

Table 2-4 suggests that by operating in line with the STOR services, clear capital savings / profits can be achieved. Therefore, an increase in the visualisation and control of the company's wastewater pumping assets could further enable an increase in flexibility to meet these targets.

Thames Water Utilities Ltd are already active participants with a STOR balancing services programme; however, to date, it only currently targets the larger sites. A previous visualisation-enabling project included the integration of existing distribution network operator (DNO) energy meters into the regional database. The data were then utilised by both the company and National Grid in the STOR service program. Although the data from the meters were accurate, the existing telemetry assets in several cases were old and failed to deliver accurately (even when upgraded from legacy dial up PSTN to always connected DSL communications). This meant that the data in the regional system were inaccurate and had no resemblance to actual demand side operations on site.

The lessons learnt through the delivery of the old STOR service will be considered during the research focus on pumping station optimisation applications. Further research on energy monitoring and the challenges presented is discussed in Chapter 3.

As discussed previously, the new Multismart outstations permit the acquisition of more accurate real-time information, inclusive of pump energy. Using this information, and considering the research aims to deliver recommendations on real-time condition-based monitoring and response systems, the potential to further reduce demand side loading via the intelligent control of pumps may assist in further STOR service responses.



There are further factors to understand when considering a STOR service. To qualify, [66] state that a STOR unit must have the capability to:

- Offer a minimum of 3 MW of generation or steady demand reduction. This can be aggregated from more than one site
- Respond to an instruction within a maximum of 20 minutes
- Sustain the response for a minimum of two hours
- Respond again with a recovery period of not more than 1200 minutes

So far, the STOR service has seen the greatest involvement from the demand side. [68] state that as of December 2009, of the 2369MW contracted to provide STOR, the demand side provides 839MW (35%) from 89 sites. Of this 839MW, approximately 750MW is back-up generation, with the secondary STOR function being load reduction services.

Targeting load reduction services will provide further efficiency incentives that may be capitalised on. However, specific issues do pose environmental risks, such as the flexibility of the response to instruction. If the wastewater levels are high, for example, and the trigger is received, then the reaction will not ensue. The cost of pollutions far exceeds any remuneration gained from load shedding.

#### *2.6.5 TRIAD Event Handling*

The National Grid charges a Transmission Network Use of System (TNUoS) annual fee that funds the costs associated with maintaining and updating the grid. Demand-side consumers who receive pass-through charges, such as large utilities, pay their share based on consumption during Triads [69].

The Triads are the three half-hour settlement periods of highest demand on the UK electricity transmission system between November and February (inclusive) each year, separated by at least ten clear days. The National Grid uses the Triads to determine TNUoS demand charges for customers with half-hourly meters [70].

Triads are forecast, and information as to their intended time is usually given 24 hours before. This information is used by the utilities as a way of reducing their current demand or by ramping up their generation assets, CHPs, diesel generators etc. However, there is always scope for an improved response.

Data from [71] suggests that for a yearly 1,400GWh demand, with 1% Triad load reduction rate, will attract an annual saving of £56,506. Therefore, 10% attracts over half a million pounds saving and thus provides a significant case for exploration.

Although the individual loads of remote pumping stations do not amass a great deal singularly, the combined load, and hence combined load reduction made possible during Triads, could contribute significantly towards energy efficiency savings.

As the research matures, the offerings of Triads will be considered in the form of load reduction across a wastewater catchment.

#### *2.6.6 Ethical Considerations*

In recent years 'Industry 4.0' has been gaining traction amongst industrial operators alike. From the history and research presented by [72], a review of the journey through the four industrial revolutions is briefly summarised. The first, which took place around the end of the seventeenth century, was driven by the emergence of steam engines producing water forces and, thus, mechanisation. The second, which came almost a century later, saw the emergence of a new energy source, namely electricity, gas, and oil. This led to assembly lines and the advent of mass production. The third revolution saw the rise of electronics, telecommunications and computers with two major inventions, programmable logic controllers (PLCs) and robots, which helped give rise to an era of high-level automation [73]. The fourth and current industrial revolution, referred to as Industry 4.0, is a concept aimed at achieving integration between the physical and software parts of a process via networks and, where achieved used for prediction, control, maintenance, and integration of manufacturing processes [72].

[74] state that a survey of popular, technical and scholarly literature suggests that part of the future is already set. Autonomous artificial agents will populate the future.

Automation within any industry is widely welcomed as a way of reducing resource hours and risk, spent on undertaking manual tasks. This will always be welcomed by stakeholders, just as long as any capital expenditure payback can be quickly recovered by the forecast operational savings. However, when considering the automation of process and plant, there are considerations to be made regarding the people with whom the automation may eventually replace.

Plant operators play a pivotal role within the utilities sector. They are responsible for the day-to-day overseeing and operation of the treatment systems and are required for maintenance, including reactive and planned. The ongoing switch to process automation has inevitably seen a reduction in the human interaction that was once required. An early example would offer the progression of pump technology over history, originally actuated by gas or steam engines in some wastewater pumping stations, as shown in Figure 2-12.

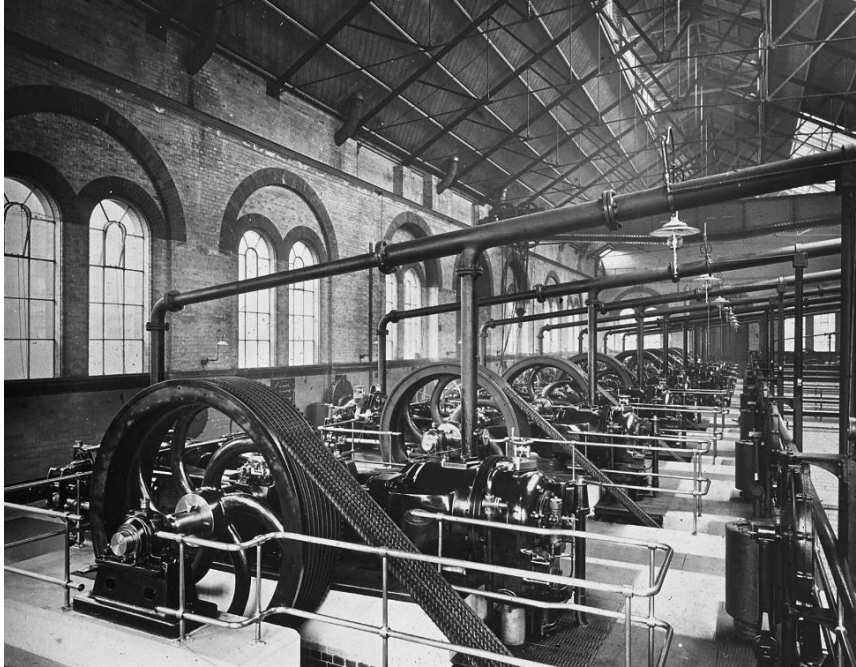

**Figure 2-12 Lots Road Storm Sewage Pumping Station [75]**

Moving away from steam engines, the same pumping station at Lots Road in Chelsea, London was updated in the early 1930s where the present diesel combustion engines, by Belliss & Morcom, were installed [76]. These are shown in Figure 2-13.



**Figure 2-13 Lots Road Storm Sewage Pumping Station [76]**

The previous gas or steam, and current diesel engine systems require dedicated operators to get the pump started and running into service. Although the diesel engines at Lots Road remain, the majority of all pumps across Thames Water Utilities Ltd.'s operation are now fully electrified and automated through control systems.

A further example: currently, most small sewage treatment facilities are now unmanned, with only failures in plant warranting the attendance of an operator. Improved telemetry systems allow the regional control centres to monitor all assets remotely and deploy operators only where required. This allows a scaled-down workforce and reduces investment in training requirements overall, saving the stakeholders revenue from operational expenditure.

However, it is worth noting a study carried out when automation was emerging within the manufacturing environment. Within research presented by [77] it is described that employment change due to automation will not be precipitous. Where it may depress the number of jobs available in physical operations, it should not necessarily cause significant unemployment. By eliminating specific tasks and by contributing to major changes in manufacturing processes and organisations automation should only displace jobs (where jobs are defined as sets of tasks performed by individuals working a standard number of hours).

Automation may reduce the number of operational tasks required by the operations associated. However, automation may only displace operational tasks into alternative requirements. For example, there may be additional resource requirements for software and ICA staff in maintaining the automation layer.

A study by [78] suggests that the human being is moving back into the loop. The study offers two primary drivers behind this hypothesis.

- Complex systems challenge modern societies with high expectations, especially when considering low-cost, safe and secure processes, which include sustainable use of human resources. Standardisation, as well as ethics, will ensure this requirement is fulfilled.
- The products and the services produced must comply with legal, regulatory and, not least, ethical rules and guidelines.

In some of the most recent studies, [79] offer a view on the introduction of 'Industry 5.0', which is based on the observation that the aforementioned Industry 4.0 focuses less on principles of social fairness and sustainability and more on digitalisation and AI-driven technologies being leveraged for increasing the efficiency and flexibility of industry.

The concept of Industry 5.0, therefore, provides an alternate view by highlighting the importance of research, development and innovation in support of the industry and its longer-term symbiosis with humanity [80].

In the view of the author, the introduction of a more intelligent control system that drives efficiency from a reduction of electrical energy within a wastewater catchment will have no negative ethical impact in terms of reduction of reliance upon humans and, thus, shall align with the intentions discussed in studies on Industry 5.0. The target company's pumping stations and their assets are already autonomous and do not require human intervention to execute their control.

If successful, the research will prove that through use of modern technologies, a more sustainable operating model could be achieved that further reduces the carbon footprint in delivering one of life's essential services. This will only serve as a positive ethical contribution.

#### 2.6.7 Risk

For any pilot project to get to trial, there are several operational risk assessments to be made. The alteration to any process may deliver positive results through a predicted reduction in energy consumption but will also include chemical, mechanical and environmental effects. These effects must be studied and understood so that any damaging risks are removed prior to delivery.

Within large treatment systems, there are strict Environmental Agency (EA) regulations on the utilities to keep within. For example, the final effluent that is discharged back into the water course must not contain ammonia or biochemical oxygen demand (BOD) above predefined levels. Breach of this will not only attract large penalties through the punishment mechanisms but will also see the harm caused to the surrounding ecosystem. Fish and other aquatic species could come to harm quickly from the dangerous levels from discharges outside permitted limits.

## **2.7 Discussion**

The new total expenditure model (TOTEX) adopted by OFWAT for the asset management period is an innovative approach that focuses on reducing the capital expenditure bias and employs whole-life costing for assets [81]. Previously, a problem statement would be produced with capital expenditure then released to develop a fit-and-forget type solution. The end result usually obscures focus from sustainability. The introduction of the TOTEX model has shifted the dial in terms of how water companies look to explore efficiencies across their existing asset base. This is a change from the previous approach that would quite often deploy more assets to meet the operational demands, challenges and efficiencies. Electrical energy consumption within the water utilities is an area under scrutiny and forms one of the major key performance indicators for the business moving forward into the new asset management period.

In the knowledge of the author, there is little research presented on the overall electrical energy optimisation across an entire wastewater catchment. Further, there is little application of these techniques on live systems. The research has discussed some applications of physical devices within SPSs [42], and these techniques have shown positive electrical energy returns. However, in the authors' opinion, they were not demonstrated over long enough periods to capture the changing seasonal / diurnal / nocturnal profiles. Further, the application used a black-box to control the site. Therefore, no understanding of the internal transfer function was available. This, in turn impacts operation and maintenance, most importantly when considering fault diagnosis. The installation also required significant electrical modifications in order to integrate.

In many cases, pump energy research and subsequent optimisation strategies focus on singular wells or receiving treatment works and do not consider the network as a collective process. By doing so will undoubtedly make the systems more complex and creates an open, non-linear dynamic system [82]. This has been considered as one of

the limiting factors to date in the current solution development for the control optimisation.

The current control of wastewater pumping systems today is limited. Each pumping station is its own insular asset with no consideration of the upstream or downstream assets it connects with. The sites are designed to maintain pre-defined conditions across a single variable only (the level in the well), with local controllers executing this task in isolation.

The current research to date has targeted a more holistic strategy that looks at optimisation and control across a wider area, with the intention of ensuring upstream and downstream effects at each site are all considered.

Part of the research will look at understanding the existing telemetry and energy monitoring assets, the new upgrades currently being delivered and how they are set to improve the data received. From here, the development of an improved efficiency model within the networks pumping shall be constructed and presented, where an offline trial on the modelling will be conducted and analysed.

The research expands upon the suitability of an existing SCADA infrastructure within a water company. Further, adopting a modular and standardised approach will improve the user experience and ultimately enable a more flexible operating platform that allows the integration of more intelligent control.

## **2.8 Summary**

Identifying a suitable wastewater catchment for the purpose of this research is a fundamental challenge presented. Once identified, the foundation for the entire project is realised. Analysis is key; it will require thorough examination and may require third-party specialist review in the form of consultation via contractors, as the proposals drafted on the data could potentially increase the risk to process should the data not be 100% accurate. For example, a flood risk may ensue if a proposal to reduce well pumping at specific time periods is approved on inaccurate data. Pollutions in the form of utility negligence leads to large fines from the EA and damages the company.

Successful investments in energy reduction methods will reduce the risk of exposure to volatile power prices and potentially return considerable savings by responding to markets as effective virtual generators. ASC research will focus on the exploitation of

sewer network capacity and the potential of reducing daily pumping and / or scheduling more efficiently so as to smooth the delivery and, thus the energy.



# Chapter 3

## Energy Submetering Within a Typical Water Company

This chapter presents the challenges and varied architectures within Thames Water Utilities Ltd.'s electrical distribution estate. It is a critical review following investment in a large capital programme deployed to obtain greater levels of asset power data. As well as the physical aspects of electrical system modifications, the research explores the data and their architecture across the end-to-end cycle (power meter to data historian).

### 3.1 Introduction

Electrical sub-metering is now key to energy monitoring within industrial and commercial premises, offering advantages in efficient building and asset-centric management [83]. For large consumers of electrical energy, it enables data for analysis across lower-level systems, which can further enable targeted energy reduction and reduce the capital energy spend [84]. By historicising this granular energy data through systems such as telemetry, and corporate tier 2 databases (examples including Microsoft SQL, Oracle DB etc.), will provide analysts the ability to trend over time patterns of electrical energy consumption with a higher resolution and thus provide insight in where a potentially poor performing asset exists. Further, this can initiate an operational reaction to either reduce the use of a particular asset through duty switching (switch to the backup device), or by completely replacing the problem device. When granular data are presented to an end user, it highlights areas of inefficient energy use and where to target for leveraging efficiency savings [84, 85].

Electrical infrastructure across the Thames Water Utilities Ltd estate varies greatly, with some distribution panels being up to 35-40 years old. Due to age and design, these panels do not comprise energy monitoring systems. In some systems, there are examples where a single current transformer (CT) has been installed on a single phase of the distribution feeder, which in turn supplies a reduced current input into an old analogue meter mounted locally on the asset. This is usually scaled on the secondary CT winding at a current range of 0-5Amps. Within more modern digital measurement systems 0-5A current loops cannot be connected directly to control and instrumentation (C&I) devices, e.g., programmable logic controllers (PLC); thus, the signal cannot be integrated within the telemetry system unless investment is used to install intermediary conversion devices. Conversely, the more recent electrical

distribution systems installed come pre-equipped with integrated intelligent power monitoring devices that utilise a variety of Fieldbus communication protocols (Profibus, Modbus, DeviceNet, Ethernet, etc.) and connect directly to the sites telemetry system via the PLC's and process control network.

Thames Water Utilities Ltd has over 4000 sites, including wastewater, clean water, environmental monitoring and corporate facilities. At each of these sites, the electrical energy is measured by Automatic Meter Reading (AMR) meters, which capture and trend how much electrical energy is being consumed. Each AMR meter produces half-hourly readings, which equate to approx. 68million datapoints per year, which in turn is used for billing and forecasting [86].

These AMR meters are, in most cases, installed as close to the point of common coupling (PCC) as possible, between the distribution network operator (DNO) connection and the customers (in this case Thames Water Utilities Ltd). For some of the larger industrial processes, AMR meters can be located in customer substations, which have high voltage incomers up to 33kV, the most common intake voltage being 11kV.

Across a selection of the largest sites, Thames Water Utilities Ltd own, operate and maintain the high voltage (HV) network. However, at these sites, the AMR meter will still only be in situ at the PCC, irrespective of its voltage rating. For the primary purpose of billing, this is deemed sufficient for energy capture of the respective site's half-hourly electrical energy consumption, which is logged and forwarded to the supplying network operator, as well as (in certain cases) Thames Water Utilities Ltd. The target energy data can be transmitted over a variety of transport layers (including PSTN, ADSL, RF, LoRaWAN etc.). In most cases, a digital pulse output from the AMR meter head is captured and transmitted to the supplier for billing purposes. The pulse is configured to defined unit measures of energy in kWh or MWh. Figure 3-1 is an extract from an HV / LV system schematic within a Thames Water Utilities Ltd process area. It gives a visual overview of the PCC from the DNO substation through to the customer assets, such as pumps and distribution boards. As can be noted from the diagram, there is only a single AMR meter, per HV incomer, at the PCC. This is denoted via the meter symbol at SG604 and SG609, respectively.

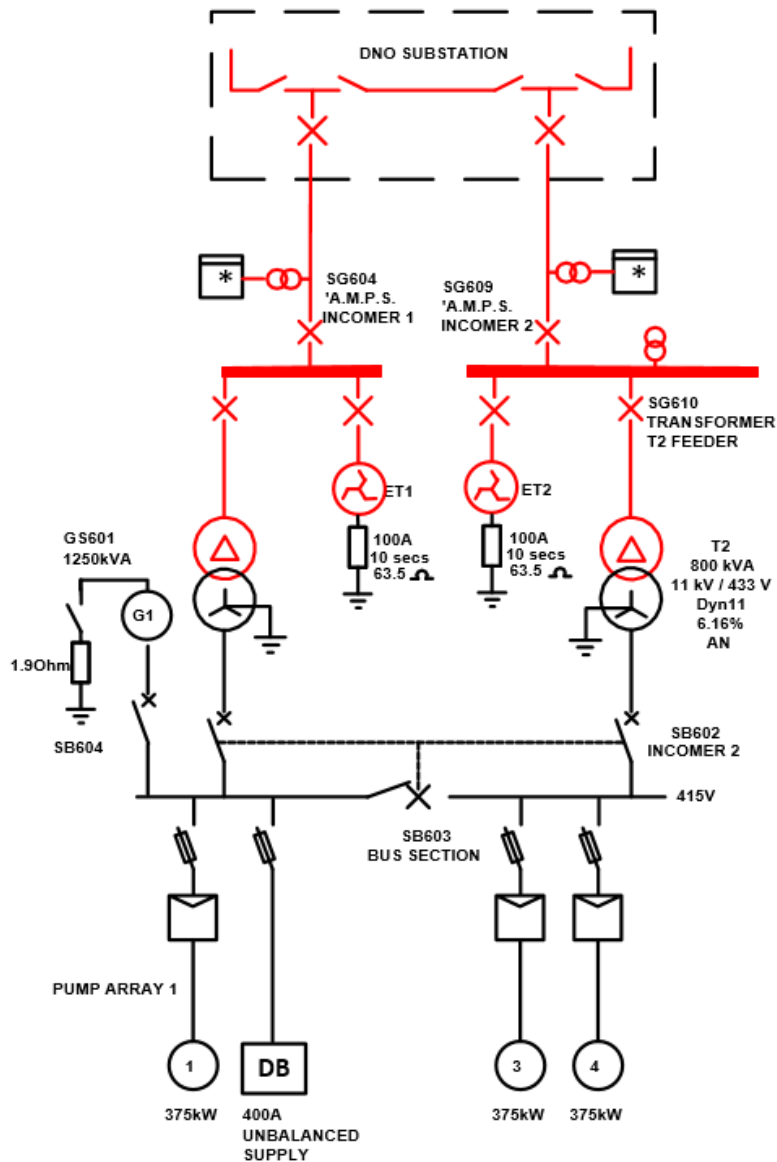

**Figure 3-1 An example of an HV / LV Bus Coupling [87]**

Ongoing energy price inflation, as well as an increase in the volatility of the market, means that for large customers of electrical energy, there is a need to be more in control of energy management, so that agreed levels of operational expenditure are not breached. Water companies have to abide by financial controls as stipulated by the regulator (OFWAT). Better control and management will also help in prolonging asset life cycles [7].

As well as the financial controls, there are further pressures set by the regulators (including corporate ethical considerations) on the reduction of carbon footprint that have exacerbated the required shift in response from UK industrial operators (including the water utilities).

Within the UK water utility Asset Management Periods (AMP's), which are five-yearly investment cycles, are determined by the economic regulator (OFWAT). The cycle starts with a price review in which the water company determines the next five year periods forecasted capital and operational expenditure (CAPEX and OPEX respectively), inclusive of customer billing rates [88]. These price reviews cap limits for the regulated companies in and dictate strategic output for capital investment. During Asset Management Period 5 (AMP-5), the period between 2010 and 2015, the price limits allowed a combined £22 billion of CAPEX across all water companies. Further to this, there was step change in the level of focus on renewable generation, with an additional combined target output of 300GWh across 12 UK water companies [89]. At the time OFWAT did not believe it necessary to put notified items or cost pass through mechanisms for future guarding against increases in energy costs because:

- 1) changes in energy prices are a risk that Retail Prices Index (RPI) indexation partly mitigates, and
- 2) the base operating expenditure figures they took forward from 2008-09 into price limits already included energy costs at a level deemed to be appropriate for many companies [89].

Thames Water Utilities Ltd, therefore, made an informed business decision to react and protect against the market volatility, by investing in an energy sub-metering programme that sought to glean a more granular energy data set from high impacting electrical assets. This included wastewater aeration blowers, large inter-site distribution pumps, ground water abstraction pumps, local power and lighting distribution boards, or any asset determined to be a large energy consumer and providing high potential for cost reduction through efficiency programmes. The electrical energy data were transmitted to the telemetry systems and tier 2 corporate historians, with the intention that inefficient devices could be flagged, removed from operation and / or upgraded with a replacement unit.

Across a water company's asset base there are significant challenges in cross-platform integration and the transfer of data between systems, with the physical limitations presented by the legacy distribution panels being more prevalent at the point of energy meter installation. However, once these limitations are overcome, and the energy signals are digitised and integrated within the local telemetry and SCADA systems, the challenge moves up the stack with configuration, offsite exportation, scaling and accuracy issues all forming problematic conditions that require resolution.

### 3.2 Electrical Asset Obsolescence

Upon initiation of the energy submetering project multiple electrical architectures needed to be investigated and understood before the deployment of any power monitoring equipment and data integration could begin. The systems were split into the following classes.

- High and medium voltage feeders
- Pre-existing discrete connection LV power meter
- Pre-existing fieldbus connection LV power meter
- Installation of new power monitoring system within an electrical asset

#### 3.2.1 High and Medium Voltage Feeders

The HV / MV systems comprised old power meters and / or needle meters on the panel fascia. These were supplied via current transformers (CTs) and voltage transformers (VTs). The meters had no usable outputs that could be integrated with the control system. Therefore, they required replacement. Figure 3-2 is a photo of an older HV section of a large distribution switchgear.

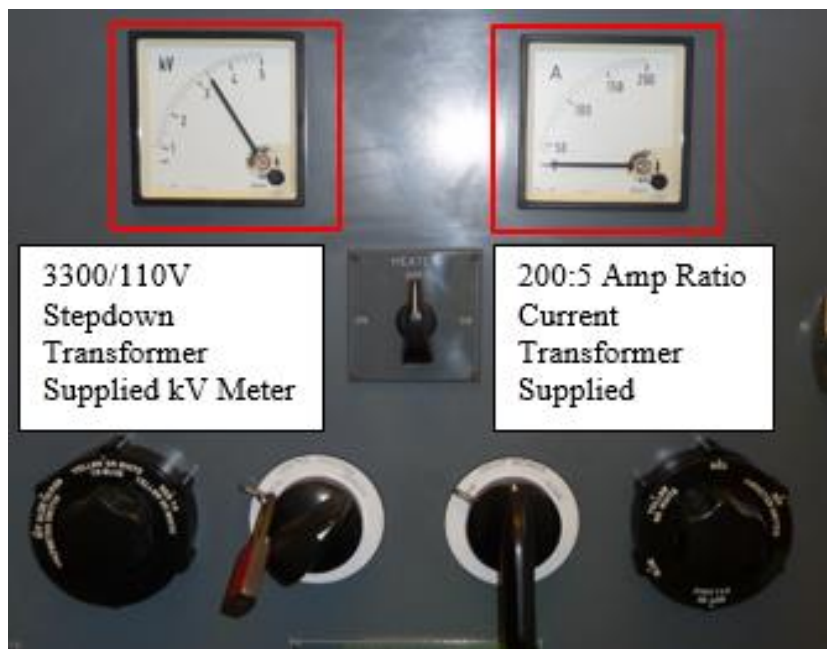

**Figure 3-2 HV Feeder and Instrumentation**

This feeder was the distribution, monitoring and protection system for a high-availability, super-critical water distribution pump. The criticality of the plant it supplied created additional complexity as, in order to perform isolation and install the new systems safely, meant shutdown times required planning well in advance (months in

some cases). Further, isolations were not to exceed 30mins in any one period. This introduced significant dependencies on the planning.

### 3.2.2 Pre-existing discrete connection LV power meter.

For the pre-existing discrete connection architecture, installation was less complex. This was due to the fact there was an existing meter in place and the engineers only needed to swap this for the newer variant. In a lot of these systems, the current transformers were pre-existing, and as the system voltage was LV, there was no requirement for an additional transformer to step down the voltage (i.e., the 400VAC was already available). With this architecture, a full electrical isolation was necessary when the electrical feeder was constructed with an interlocked switch disconnecter (a mechanism that prevents that door from being opened whilst energised) as per Figure 3-3. All plant and processes downstream of this isolation would, therefore, require removal from service, subsequently impacting the associated processes. Further, it was not always an option to take these systems out of service due to other limiting environmental factors, such as rainfall, consumer demand etc.

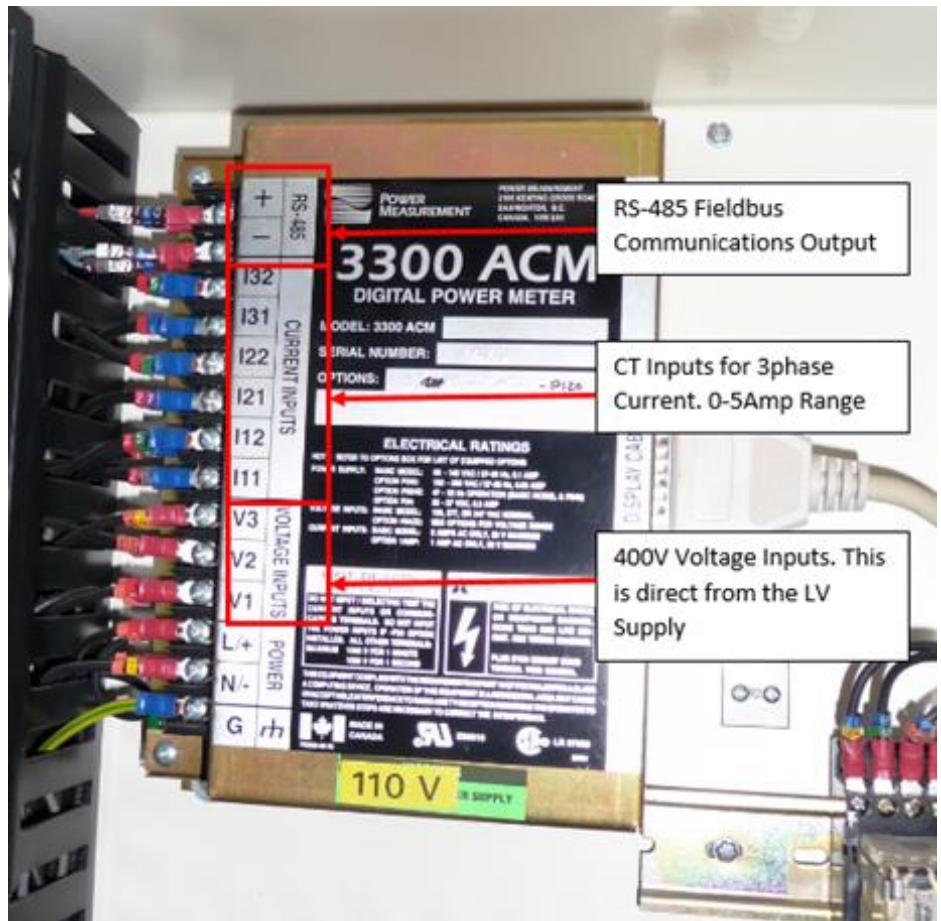

**Figure 3-3 Existing Analogue Power Meter**

### 3.2.3 Pre-existing Fieldbus connection LV power meter.

Across some of the more recently installed electrical systems, there were pre-existing power monitors that came with an optional Fieldbus connection, and this connection was available for integration onto the telemetry system via the process control network. In this instance, all that was necessary was for the power instrument's configuration /

reconfiguration and commissioning. In certain cases, including that of the unit shown in Figure 3-4, the older serial-bus RS-485 output would require legacy PLC communication modules that were not readily available and unsupported by the product vendor. Where a communications module in the PLC did exist, the configuration / reconfiguration and commissioning of the electrical energy signals was a relatively low impact task. However, due to the high cost of replacement units and the availability lead times in excess of 3 months, it was sometimes deemed more cost effective to replace the unit with a new sub-meter when the modules failed [8].



**Figure 3-4 Existing Fieldbus Power Meter**

**3.2.4 Installation of a new power monitoring system within an electrical asset.**

This approach was the most complex and costly installation type. It was not permitted on any HV or MV system due to an unacceptable balance of risk vs benefit. The full installation of all power monitoring equipment was required for any LV electrical system where no power monitoring existed. The largest risk from this was the current transformer installation. Many of the older distribution systems comprised open exposed solid copper busbar systems, which increased complexity due to the rigidity of the bars, and thus the retrofit of a current transformer was, in most cases, not

possible without wholesale reconfiguration. This, in turn meant longer isolation times on the target feeder. Operational restrictions would, in most cases, dictate that a return to service time of 15 minutes was in place, such that if the process environment changed and operations needed the device back in service, they could instruct this at any moment [8].

Although the option to use Hall-Effect transducers was a possibility, as by knowing the proportionality constant between the Hall voltage and the magnetic field strength the current flowing through the conductor can be calculated, it was not taken forward as under this piece of work due to cost, training and calibration concerns.

### **3.3 Power Monitoring**

The energy sub-meters chosen for the application required flexible connection configurations across varying architecture of LV systems. This included

- Non-balanced loads,
- Balanced loads,
- High Voltage systems with transformed voltage references and limited current transformer availability.

Conformance with the European Measuring Instruments Directive - MID 2004/22/EC [90] was also a requirement of the power monitor as strategically the energy data collected could be used for renewable obligation certification scheme (ROCS) for feed-in tariffs (FIT). If an energy meter conforms with MID, then, from the 30th October 2006, the UK government permitted it towards the use for any ROCS or FIT [91].

Across UK LV 400/230VAC systems, there will be a presence of current in the neutral conductor for any distribution board that incorporates building services and / or unbalanced loads. As such, any installed energy meter required the three Wattmeter method, and unbalanced 3 phase wiring configurations as per Figure 3-5 to ensure the greatest accuracy.



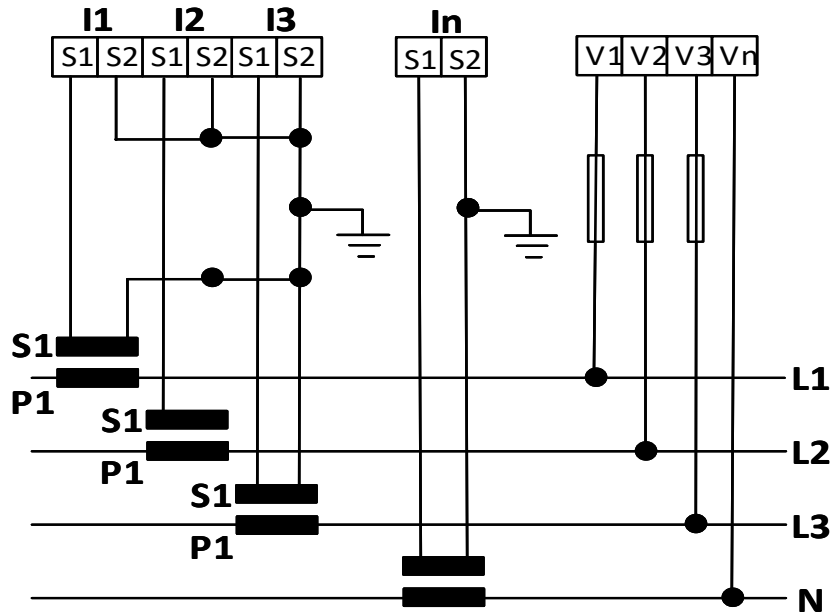

Figure 3-5 Unbalanced Load 3-Phase 4-Wire Connection

For a two Wattmeter configuration, Figure 3-6 provides the connection details for the measurement device.

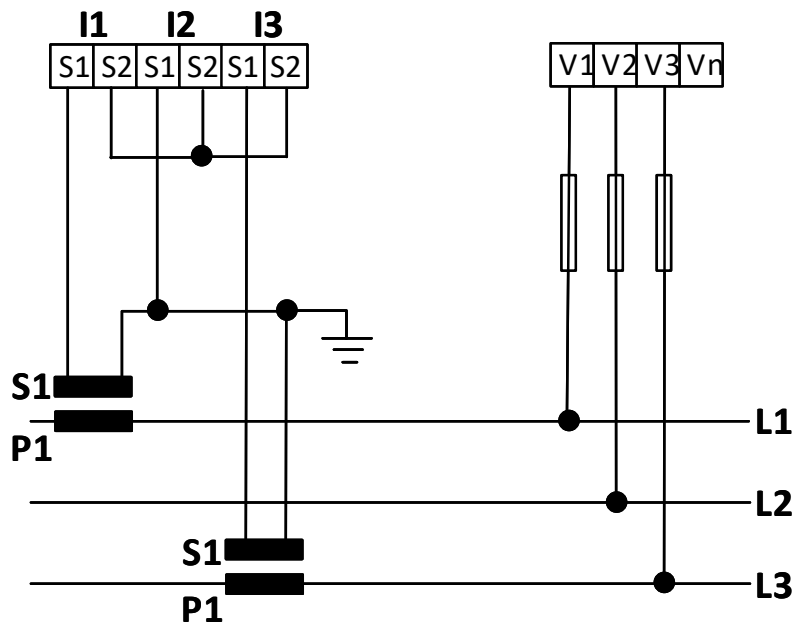

Figure 3-6 Unbalanced Load 3-Phase 3-Wire Connection

For full installations on any unbalanced load, the preference of installation was for the 4-wire, three Wattmeter configuration due to increased accuracy. This required the installation of four current transformers. Where current transformers were pre-existing on any 2 of the 3 phase lines, the 3-wire two Wattmeter configuration was utilised

based on Blondel's theorem. This calculated the 2nd and 3rd phase currents through vectorial summation but led to a 0.5% reduction in phase accuracy [92], which, based on risk and cost reduction, was an tolerable accuracy burden.

For the majority of electrical motors used to actuate pumps in wastewater systems, comprising a 3-phase balanced load, the most efficient way, in terms of risk and cost, to measure power was via a one Wattmeter method. This is shown in the schematic in Figure 3-7. As these motors are connected via a delta configuration (with no neutral conductor present), all phases must balance. Thus, there is no need for vectorial summation as all line currents are equal.

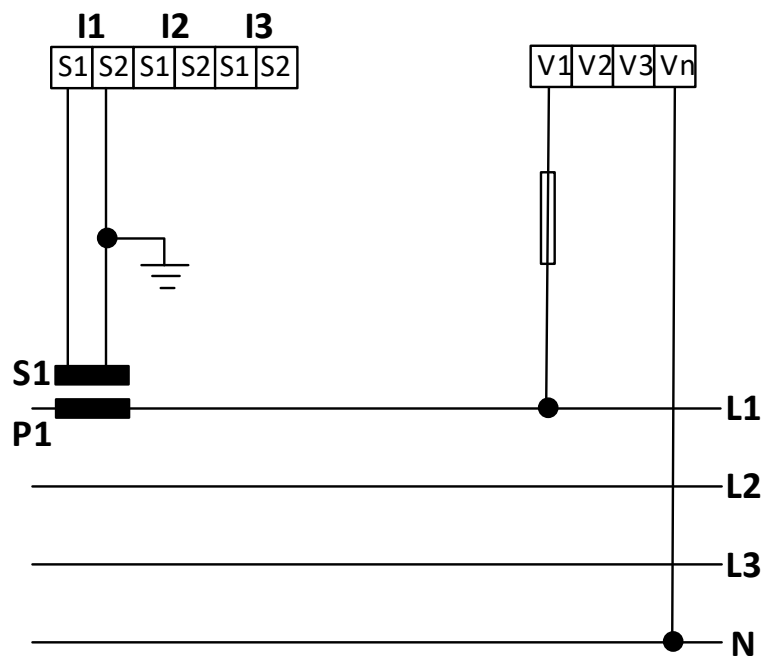

Figure 3-7 Balanced Load 3-Phase 3 Connection

### 3.4 Data Architecture

The connection of the power monitor to the corporate tier 2 historian completes the operational chain from substation to customer [93] and thus liberates the data.

#### 3.4.1 The Purdue Model

The Purdue model, formally the Purdue Enterprise Reference Architecture (PERA), is a structural model for industrial control system (ICS) security, concerning physical processes, sensors, supervisory controls, operations, and logistics [94]. It is used to provide an operational framework for which the differing levels of physical/logical architectures, and their handshakes, interact. It is widely adopted within the water

industry as the framework for constructing dataflows from sensor all the way to enterprise. It is a crucial enabler for this research project as the data will need to be conditioned to transact across this stack.

Developed in the 1990s by Theodore J. Williams and members of the Purdue University Consortium for computer integrated manufacturing, the Purdue Enterprise Reference Architecture (PERA) defines the different levels of critical infrastructure, of which a water company can be categorised as used in production lines and how to secure them [95]. The Purdue levels are shown in Figure 3-8.

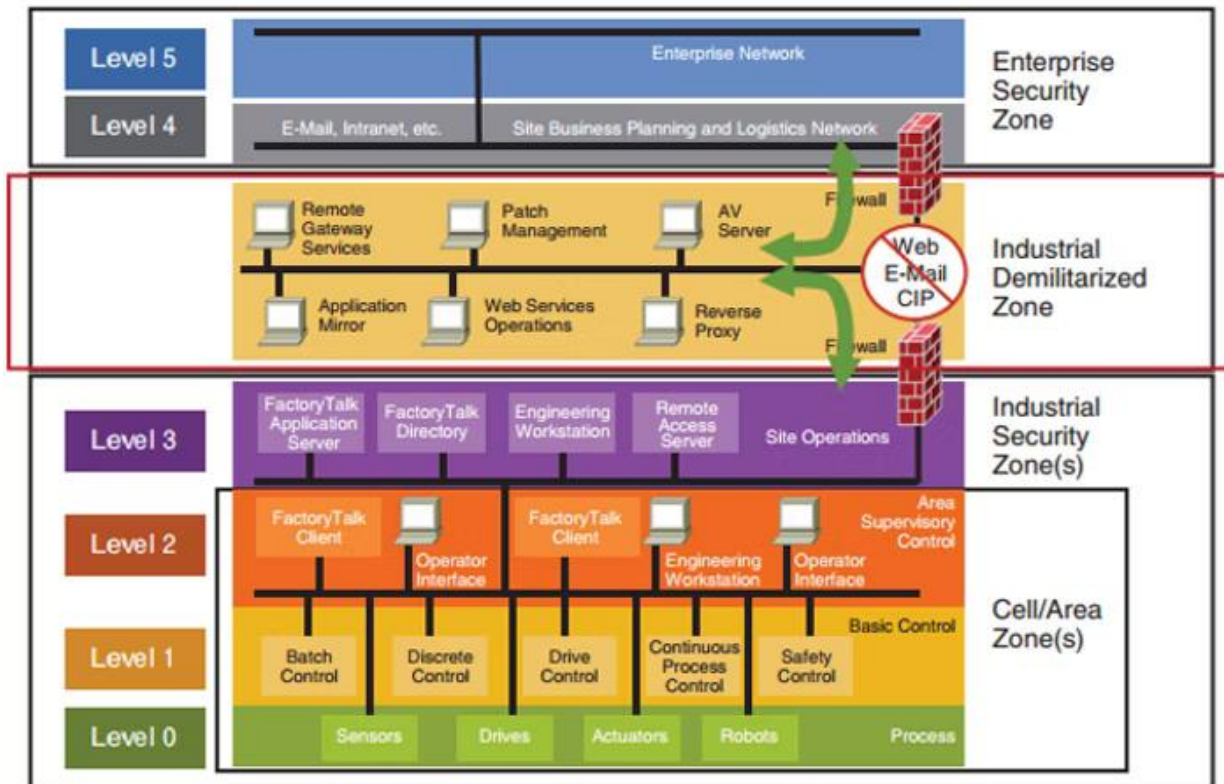

**Figure 3-8 Graphical overview of Theodore J. Williams Purdue model [96]**

- Level 0 – Physical devices within the application process. (Flowmeters, pumps, valves etc.)
- Level 1 – Intelligent devices that take sensory information from and send actuate instructions to level 0 devices. (An example could include a PLC that connects to a level instrument and pump. It then takes data on the water height in a well and, using some logical operator, executes a command to start the pump and thus lower the level in the well).
- Level 2 – Supervisory control and data acquisition – SCADA. This is used by humans to supervise, monitor, and control physical processes. It can manage

systems via long distances, where physical separation from the plant exists and where the programmable logic controllers (PLCs) are usually deployed within the plant.

- Level 3 – Industrial Security Zone. This is where the production workflow is managed on the manufacturing floor. Customised systems based on operating systems such as Windows are used to perform batch management, record data, and manage operations and plant performance. The systems at this level are called manufacturing execution systems or manufacturing operations management systems [95].
- Level 3.5 – Industrial Demilitarized Zone. An update to the original Purdue model based upon increasing cyber threat actors in industry, this level covers security systems, such as firewalls used to separate the Information Technology and Operational Technology (OT) domains. At this point, the IT and OT domains converge, thus increasing the attack surface for the physical assets within the OT system.
- Levels 4 & 5 – Enterprise Security Zone. This is the traditional IT zone for enterprise. This is the area where business-as-usual IT systems and applications are deployed, including email servers, enterprise resource planning (ERP) systems and corporate databases such as Oracle.

#### *3.4.2 A Water Company's Data Architecture*

As part of the Thames Water Utilities Ltd sub-metering capital programme, there were additional requirements to capture performance data from the site's process. This was done for both long-term and short-term frequencies. Based on control room operator demands for short-term frequencies, the data trends for the site assets performance were set to range between the current time, the previous hour and the previous ten days. This was agreed as the optimal range to augment a controller's ability to identify any potential short-term performance changes [8].

For long-term, the data were required to be presented at an external level to enable reporting and performance analysis by site managers and business users, including the carbon and energy analytical team. The long-term data were migrated from local site SCADA proprietary databases to the off-site tier 2 corporate historians.

For compliance, it was a mandatory requirement to ensure all data were date / time stamped with every recorded value. Further, the date / time stamp must be assigned at the point the data were acquired from the energy meter, not at the point the data were recorded in the historian. This requirement ensured protection against any potential latencies in data propagation throughout the stack. In order to ensure this compliance, the local site SCADA system was set as the time master, with all connected level zero and one node synchronising with it for their own times. Figure 3-9 is an overview of how the data are transferred across the architecture levels and Purdue model. The data originate from the individual process meters, in this case the energy meter, and finally end up at the external analysis tool. Each stage in the data journey is described below.

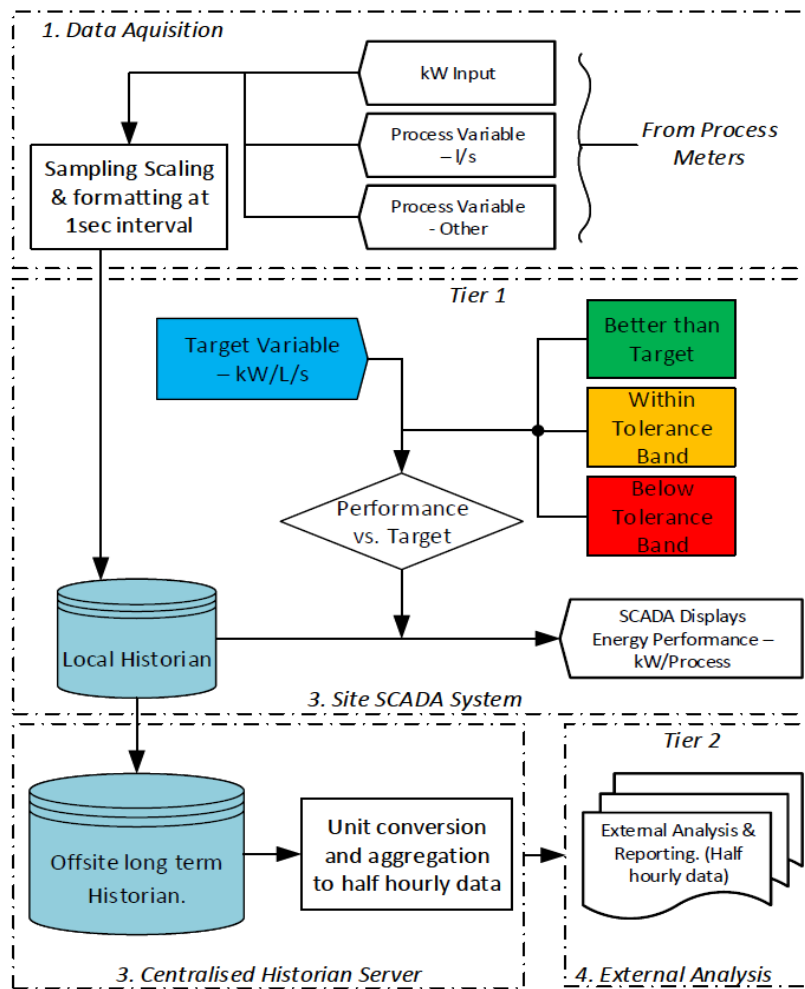

**Figure 3-9 Energy data flow architecture**

### 3.4.3 Data acquisition

The electrical energy meters were polled at an interval rate of once per second. The raw data inputs were presented in the form of electrically discrete 24VDC 4-20mA

current loop signals. These were then scaled within the local PLC to an engineering unit range. E.g., 4-20mA equates to 0-100kW (4mA = 0kW, 12mA = 50kW and 20mA = 100kW).

In terms of commissioning and issues relating, scaling was the single biggest issue with regards the accuracy of the data. The primary driver being the Thames Water Utilities Ltd estate comprised multiple vendor types for PLC, SCADA and telemetry infrastructure, where multiple scaling ranges were available. The differing variety and combinations resulted in a large range of scaling options, which led to inconsistency in the data commissioning.

As an example, a Rockwell CompactLogix™ programmable logic controller and associated analogue input card can scale a raw 4-20mA input into any one of four formats (table 3-1).

**Table 3-1 Rockwell PLC Scaling Example**

<b>Operating Range = 4-20mA</b>	<b>Data Range</b>
Raw / Proportional	-32,767 to 32,767
Engineering Units	3,200 to 21,000
Scaled for PID	0 to 16383
Percentage Range	0 to 10,000

Further, the local site SCADA systems used in the first line of data capture and historization differed from site to site. This exacerbated potential for commissioning errors within the scaling and presented significant challenge in ensuring data integrity throughout the Purdue stack.

At a human level, skills and knowledge gaps could occasionally impact the quality of the system commissioning and therefore, the quality and validity of the energy data. There were examples of commissioning incidents where an individual resource, proficient with a certain type of PLC, was not as proficient with the local site SCADA product. Therefore, a need for additional resources throughout the data commissioning was required. This, in turn led to miscommunication and interpretation errors being made in the data scaling. There were further complexities surrounding the commissioning of the physical energy meter as this was, in most cases, completed by a separate contractor and not the PLC, telemetry and SCADA systems integration team. This meant any physical issues were not discovered until much later in the project, when verification of signal accuracy could not be established.

#### 3.4.4 SCADA

Energy meter data located within data files in the PLC is subsequently polled by the local site SCADA system or Remote Telemetry Unit (RTU) and displayed on mimics either locally on-site, or regionally in a control room, respectively. Energy performance can then be compared against benchmarked values, with alerts set to trigger when any out-of-boundary condition is detected. At this first step of data capture the system applies the date / time stamps to the data.

Additional complexities came from the varying obsolete SCADA applications deployed across the Thames Water Utilities Ltd operational estate. Further, some would be running on end-of-life or unsupported operating systems and hardware. Data mining for the purpose of reporting was, at times unachievable from these systems. On occasion, data would be limited to a selection of sites where modern systems were installed [97]. Mitigation in these scenarios employed a third party 'virtual RTU', which was deployed locally on-site and collected the data from the PLCs via an Open Platform Communications (OPC) link. It was in this virtual RTU that the date / time stamp was applied.

Data from the local site SCADA or RTU database was then propagated forward to a centralised corporate Oracle historian. At this point, the data was attenuated into sample rates of 5-minute intervals and then aggregated into reportable half-hourly values. Once in the Oracle DB, the data were presentable for export and external analysis by the energy team using Oracle / SQL queries.

### **3.5 The Benefits of Power Monitoring**

Upon completing the installation and commissioning of 405 energy meters, business users were enabled with enhanced visualisation of their site assets' electrical energy demands. This enabled a platform to deploy optimisation techniques to improve asset performance and reduce unnecessary energy consumption. Optimisation primarily came through identification and removal of failing or failed assets. Further, where additional process variables (flow, level, pressure etc.) were logged within the Oracle database, tools were constructed to correlate these variables against the newly available electrical energy signals, leading to power against work done data trends. By having a data variable that logs power against work done (for example, kW per litre of water pumped) provided analysts with early warning systems when devices started to degrade against their design output. This led to a saving in energy demand of 6.5GWh/year [98].

The improvement in available energy data also contributed to the further optimisation of 8 sewage aeration treatment systems, improving their controls, thus, achieving a further power reduction of 3.7 GWh/year [8, 28].

The Thames Water Utilities Ltd energy metering project was deployed to seek an enhanced understanding of inefficiencies across its electrical asset base. This was achieved across a selection of high-impacting assets throughout the install base. As a result, and through efficiency strategies, there have been significant improvements in the way these assets are owned, operated and maintained, including:

- Improvement in the ability to forecast where devices are beginning to fail.
- Prioritisation of asset upgrade.
- As a precautionary option, the demotion (or inhibition) of an asset within a duty roster until funding could be made available for upgrade or repair.

There has been a significant reduction in the use of electrical energy as a result of smarter asset utilisation, driven by the data dashboards the newly installed energy meters liberated. This further reduced operational expenditure, which has led to additional capital being invested in increasing energy metering throughout the electrical install base.

It should be noted, however, that in some cases, the capital expenditure required to achieve new energy meters on a per-asset basis does not always offer the most efficient cost reduction method. Within certain electrical distribution systems, installation costs exceed the acceptable return on investment. Suppose an electrical distribution system is flagged in any future investment cycles for replacement. In that case, it is concluded as being more cost-efficient to wait and prioritise an alternative method for energy metering, where a better return on benefits can be realised.

As a recommendation, the research concludes that further savings could be leveraged if a standardised framework in data scaling is developed and applied. This could be achieved through use of data block templates, which have embedded functions and can be adopted across multiple SCADA vendor types.

### **3.6 Summary**

Thames Water Utilities Ltd installed 405 energy meters to visualise site assets' energy demands. Optimisation techniques improved asset performance, reduced energy



consumption, and identified failing assets. Correlating process variables with energy signals enabled early detection of device degradation, saving 6.5GWh/year.

Energy data also optimised eight sewage treatment systems, achieving a further power reduction of 3.7 GWh/year. Asset ownership, operation, and maintenance improved through better failure forecasting, asset upgrade prioritisation, and temporary demotion of assets awaiting funding.

Smarter asset utilisation reduced energy usage and operational expenditure. This led to increased capital investment in expanding energy metering. However, per-asset meter installation may not always be cost-effective. Alternatives should be considered during replacement cycles to ensure better returns.

The research suggests developing a standardised framework for data scaling. Utilising data block templates across telemetry vendors would enhance efficiency and data analysis.

In summary, Thames Water's energy metering project improved efficiency and reduced energy consumption. It identified failing assets, optimised operations, and prioritised upgrades. Smarter asset utilisation led to energy and cost savings, while a standardised data scaling framework is recommended for future improvements.

# Chapter 4

## Standardised SCADA Templating

This chapter proposes a common object templating library for the application in any future deployment of an optimised wastewater catchment trial, following the successful offline hydraulic model optimisation. It further proposes how Thames Water Utilities Ltd.'s standardisation and use of a modular approach to SCADA applications can be used to further support future optimisation of assets when considering the deployment of software tooling. Finally, the chapter concludes on the proposal surrounding human factors within a control room and how this must be considered when deploying change to the operation.

### 4.1 Introduction

For any optimisation of pumping station assets to be a real-world consideration, the PLC, telemetry and SCADA infrastructure (including the operators who own and operate it) will need to be adequately installed / commissioned and trained / bought-in respectively [97].

As the availability of faster processing power at more affordable prices increases, water utilities are becoming increasingly able to leverage this resource and deploy computational platforms that are far more powerful and robust. This further liberates improved data resolution and efficacy. An increase in data efficacy provides process analysts with a more robust foundation to construct and operate their modelling algorithms. In turn, this increases the value the data bring to an enterprise and the efficiency with which they are stored, accessed and retrieved [99].

The more data there is however, the greater the need for the utilities to construct a common information model (CIM) that traverses all business units, with the justification coming from extended asset lifecycles through an improved understanding of data mining and analysis techniques. The rule sets created can be applied across the vast quantities of operational, as well as customer based data the data stores hold [101].

For years, centralised visualisation of process plant, including the storage of critical infrastructure data variables, has been built around the SCADA systems, where operational controllers can monitor and execute commands to the systems process and assets. [102].

SCADA infrastructure, as a rule, is generally deployed across centralised datacentres [103], this is further concluded by the research when studying the Thames Water Utilities Ltd portfolio. Any water company's estate, however, will comprise large physical asset install bases distributed disparately across a geographic catchment spanning multiple districts and counties. This comprises regions of varying topography, geology and land use, and thus, the SCADA systems are sometimes disconnected from the central historians, with the local operating system providing a single point of access to the historical data.

Providing improved mechanisms for connecting these pockets of isolated data sources will conclusively improve the structure of a water company's data challenge [101]. When executed correctly, the results will include faster links to the data and permit real-time trending and event handling (through remote control), which will leverage the ability to operate the target control system more efficiently. For example, if a wastewater site was to receive a deluge of influent, out of normal working hours, on a site that is not manned 24 / 7, there is a process risk introduced that could lead to pollution and environmental consent breaches. These consent breaches cost water companies large amounts in fines every year [104].

A review of the Thames Water Utilities Ltd annual report and financial statement for 2014 / 15 detailed pollution information highlighted issues relating to breaches of the upper control limit set by Ofwat [105]. This leads to the below-ground asset performance being marked as deteriorating and can present commercial pressures for the company.

Advances across SCADA platforms and architectures, including associated connection mechanisms, enable users to connect from multiple locations using remote access protocols (such as Microsoft remote desktop, RDP), further enabling the ability to monitor and execute control commands. This architecture provides a toolset for remote reactive mitigation strategies, which increases the availability of skilled operational resources to intervene and prevent critical events.

In parallel with an ever-improving availability of computing resource, networked control systems (NCS) are also enhancing within their technology space, providing considerable speeds and bandwidths and further permitting greater data packet transfer rates [106]. These improvements, along with an increase in the availability of actuators, sensors and controllers utilising Fieldbus as a data transport medium, allow for a greater data resolution to be distributed across a process control network. It can

achieve this without increasing any direct electrical connections, i.e. physically discrete signals such as 24VDC Boolean and 4-20mA Integer, that require copper conductors for each signal [107]. Traditionally, a legacy instrument (such as a level or pressure transducer) may have utilised a single discrete 4-20mA output (with two physical copper conductors) and a 4-bit array of digital outputs (with five physical copper conductors, one reference voltage and four signal returns). The installation of this system would have required signal conductor segregation through electromagnetic compatibility (EMC) requirements. Conversely, Fieldbus systems can encapsulate multiple devices, with multiple packets of analogue and digital data, which can all connect together over one set of copper conductors (not considering auxiliary power supplies per specific device) due to each device having its own node address [97].

This seriously reduces installation cost and time with regard to installation of a cabling system that caters for a pair of copper conductors for every required signal. Additional benefits also include an increase in the distances permitted between the instrument and control system, with low-frequency communication and easy integration in the field [108].

## **4.2 Legacy SCADA Architecture**

Across several UK water utility companies and their treatment facilities, there are multiple process types. At the highest level, these can be split into two parent categories: clean water production and wastewater treatment. However, within each of these categories there exists huge variety of internal inter-stage processes. As a rule, a treatment site will grow and develop organically over time, this is generally the result of new processes being added intermittently and in conjunction with approved capital investment. As a result, the technology on site will be varied and comprise that, which was available at the time of system installation. This, along with limited governance models, in place for ensuring alignment, can lead to a wide diversity across the applied site SCADA types.

An example sewage treatment application, as per the process block diagram (PBD) shown in Figure 4-1 takes effluent from a small town. Population equivalent (PE), circa 10,000 people.

A site of this nature will typically comprise primary filtration, oxidation and secondary filtration processes. Each area will likely have its own designated PLC, which could

include several hundred inputs and outputs (I/O) per device. The items coloured red in Figure 4-1 indicate control system integer variable inputs.

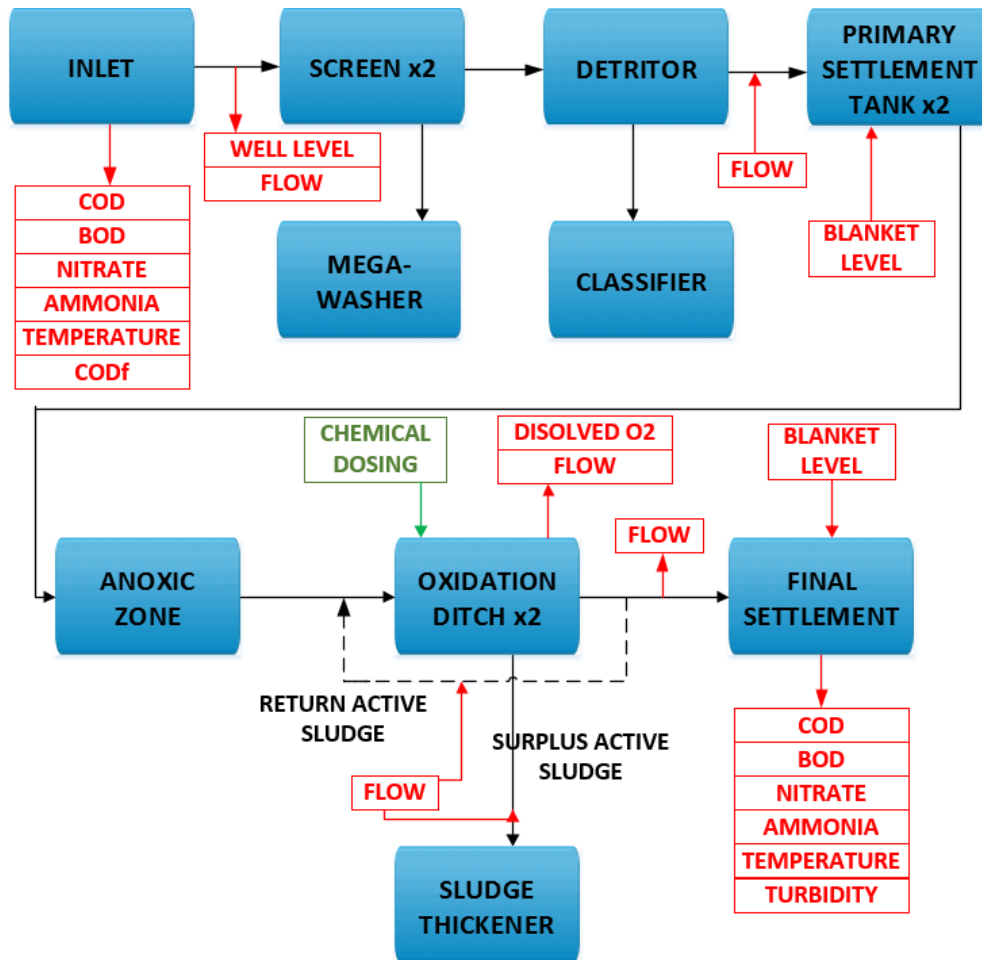

Figure 4-1 Typical Sewage Treatment Process Block Diagram [97]

For this site architecture type, a shift controller (human on-site making control decisions) can operate the SCADA approx. 20-60 minutes per day.

In contrast, for larger clean water production plants, an example as per the PBD in Figure 4-2 below, can supply drinking water to urban areas with PEs in the hundreds of thousands. These sites will include several complex processes with integrated control systems, comprising thousands of I/O per process area. For the majority, sites of this size and complexity are manned 24 / 7, with the shift controllers using SCADA as the primary controlling tool.

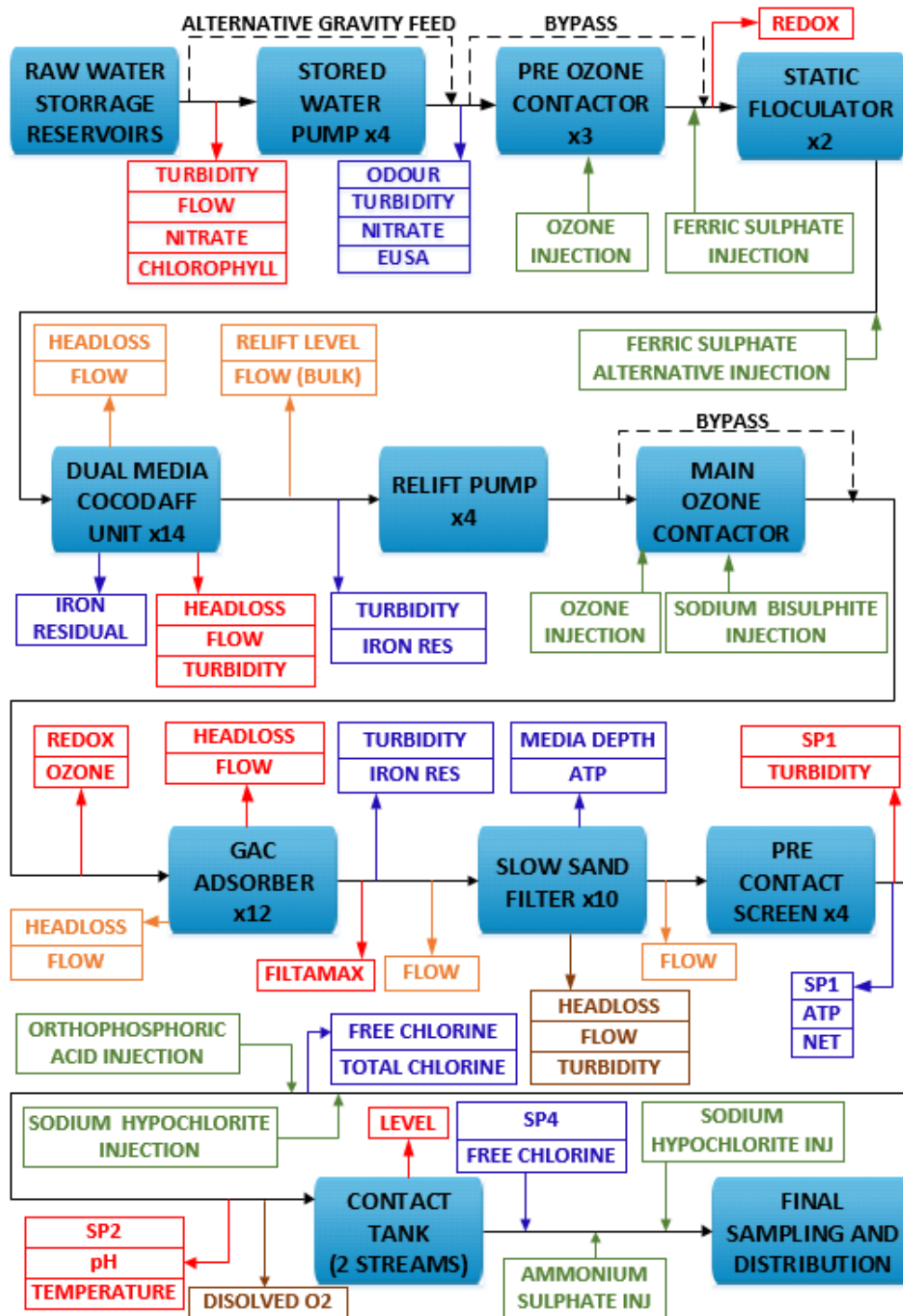

Figure 4-2 Large Clean Water Process Block Diagram [97]

SCADA can be built using multiple communication protocols. Within Thames Water Utilities Ltd, the research lists the following:

- Object Linking and Embedding for Process Control (OPC),
- Inter-Control Centre Protocol (ICCP),
- MODBUS,
- Distributed Network Protocol version 3 (DNPv3), IEC 870.

- Simple Network Management Protocol (SNMP)

The incumbent site systems vary in design and functionality based on age and / or location. They are usually not integrated, cross-platform with regards to a control or data perspective. The non-standardised, and in some cases bespoke, approach has led to several issues regarding the serviceability of the SCADA system. This drives an additional complexity as many of a company's operations and maintenance teams need to be divided into discrete areas of expertise and are spread thinly, subsequently leading to an increase in the reliance on costly external resources. For example, one operational area will have experience in the Genesis 32 Iconics™ platform. This system utilises SNMP for monitoring and management. Further, the direct graphical animation tagging is built on OPC, with plant floor device communication and enterprise infrastructures business objects, such as SAP™ and Oracle™ also in the mix [109]. Within another area of the operation, a General Electric Intelution FIX32™ system will be in use. This system was built using an indirect database for I/O management and control. It will also comprise separate proprietary drivers for connecting to process control assets. Where gaps in expertise exist, this leaves a company exposed and at-risk during failure mode events, which may further lead to significant issues, including costly pollution.

As the speed of technology advance increases, the author observes that for the more complex systems on a water company's estate, it becomes more difficult to keep these systems in line with the latest revisions. These systems are usually concentrating tens of thousands of signals (discrete / soft / analogue / digital), comprise multiple connectivity drivers, run back-office scripting for reporting etc. The original vanilla out of the box SCADA package is no longer vanilla due to the complex needs from a water company needing to operate across many different processes and as such it is not a straightforward exercise of upgrading from one version to the next. In order to do so takes huge levels of testing and governance to ensure all functionality remains intact.

This ultimately leads to a water company having a diverse portfolio of SCADA systems on differing versions, which requires an increased engineering knowledgebase to be able to ensure all the variations in interoperability are adhered to.

In these instances, the liberation of data crucial for reporting and business decision-making proves difficult and is constrained to only those sites that run the newer systems. Where it is unacceptable to omit this data, acquisition is performed by labour-

intensive manual download and significantly burdens a company's subject matter, expert support teams.

Further, where data are available, they are not always reliable due to inconsistencies in database structure and naming. The aforementioned organic growth of a water company's site, and the omission of a governance model from the start, have led to additional challenges in asset tagging and naming conventions, which makes data collection within a central repository more complex.

Under the lessons learned following the turn of the millennium (Y2K), central standards were adopted, which gave rise to greater consistency in the delivery of new systems. However, even these systems are now classed as legacy applications, with most of the hardware and operating systems failing to meet the integration requirements of the utilities operational management centre [97].

The research has found that across the target utility, there are multiple SCADA systems comprising several product vendors that include Aveva Wonderware (current), Rockwell RSView (legacy), FTView (current), Paragon (legacy), Fix32 (legacy) and Iconics (legacy). As a result, several operator client workstations exist, offering different data acquisition methods. As data governance models and structuring standards have been published after the installation of legacy systems, these systems do not always align with the standard. This has led to inconsistencies in asset tagging, which further leads to constraints in what data mining and analysis can be performed.

### **4.3 Revised SCADA Architecture**

Within Thames Water Utilities Ltd, a capital investment programme was previously established to upgrade many of the aforementioned legacy systems. One of the key objectives of this programme (as well as getting all systems back into manufacturer support) was to build the new systems using a standardised modular approach. This was achieved by using a single vendor technology, Aveva, Wonderware, and System Platform, which can be architected and deployed across systems of varying size and complexity. Additionally, the company's internal governing SCADA standards had been mandated for application across all new capital projects. This was instructed to migrate to a SCADA estate of consistent database construction and visualisation.

Sites were categorised as small, medium and large. All hardware was standardised using Dell blade servers which incorporated a redundant array of independent discs



(RAID) level 5. To standardise further, only two models of server were used. For large and medium sites, Dell Poweredge R700 series servers were installed; for small sites, the Dell Poweredge R300 series servers were used. Note: this was at the time of writing, and as technology progresses, so too will the spec.

The server architecture was built on a virtual solution using VMware ESXi™. The use and reliance upon virtualisation techniques were proposed in line with research conducted by [110]. Virtualisation offers flexibility by using one or more virtual machines (VM) within the single physical host, enabling the deployment of multiple resources. The computing resource used for providing the infrastructure for a virtual computer abstraction is the virtual machine monitor or hypervisor. Traditionally, there are two hypervisor constructs, Type 1 and Type 2. Type 2 is where a computational resource OS is installed directly on the physical hardware. Here, the hypervisor runs as an application over the top. Type 1, which is what was used for the purpose of the programme under review, is where the hypervisor executes directly on the hardware and additional computational resource is deployed below the hypervisor. The use of type 1 eliminates the need for any singular master operating system, which would incur additional costs and updates.

As part of the upgrade programme, all new application, historian and terminal server computational resources were deployed on a type 1 hypervisor. The advantage of virtualised resources was that they provided Thames Water Utilities Ltd with the tools to manage the systems remotely and securely using an internal resource pool. Virtualisation of the computational resource further reduced the number of physical servers by permitting multiple operating systems to run on a single physical host. This increased efficiency in hardware deployment and operating costs by reducing administration overheads, datacentre footprint, power and cooling. The virtual environment also provided resilience via the Veeam™ backup and recovery utility. This resilience came following consultation with [111] and was via the provision of recovery times and point objectives of <15 minutes for all virtual applications.

When the research investigated the architecture, the computing resource was using Microsoft Windows Server 2008R2. This was installed across all server operating systems, with a secure Windows 7 image installed on the operator client workstations. Workstations were domain-integrated computing resources but were heavily locked down and only permitted to run a handful of services, including the remote desktop protocol (RDP), which was used to view the SCADA applications.

All SCADA applications were built on the Aveva System Platform product and were deployed across several computational resources, these included: Application, Galaxy Repository (GR), Terminal, and Historian Servers. Each Aveva server was installed on a Microsoft VM which hosted the object / scanning engines, database configuration (known as a 'Galaxy'), visualisation applications and historical databases respectively. All databases were built on Microsoft SQL. The terminal servers used a proprietary client application, providing operators a visualisation layer through mimics and alarm displays. These were accessed via a terminal server.

Templating the VM images and securely restricting areas of the resource enabled a consistent configuration which was able to be repeated across all newly installed sites. The VM images came preloaded with batch files, which were written to provide the installer (internal or external contractor) with a predefined, governed, installation methodology. This eliminated site-by-site specific configurations and further reduced the risk of different installers' interpretation on how to set the system up.

Across Thames Water Utilities Ltd, many of the sites comprise a separate telemetry RTU that operates independently of the site SCADA and report directly to a regional SCADA system. This too provides alarming and visualisation of process critical data; however, instead of presenting the data at a site level, this is inspected and informs decisions at a fully remote, 24 / 7 operational management centre. The technologies used by site and regional SCADA differ; however, they are enabled to interact with each other using OPC and Distributed Component Object Model (DCOM) protocols. Figure 4-3 shows the high-level overview of a site's data journey, which starts at the local field device and progresses up the stack (traversing the Purdue levels) via site SCADA, telemetry RTU, or both, and ends up in the regional telemetry SCADA system.

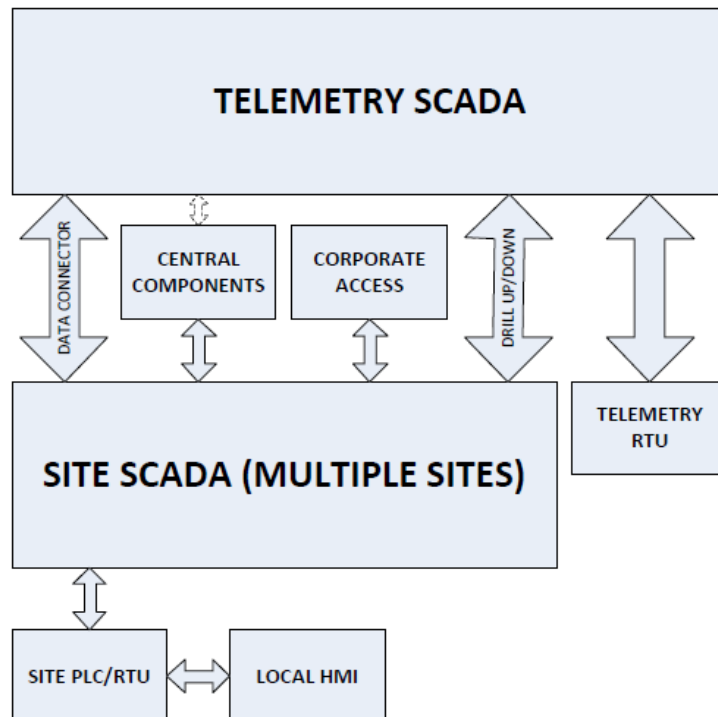

**Figure 4-3 Interconnectivity of Operational Data Systems [97]**

When considering the levels of the Purdue model mentioned in chapter 3, a corporate visualisation layer exists on the enterprise (level 4/5) side of the demilitarized zone. This enables a wider user pool of non-operational users to access key system data in a secure and controlled manner. By liberating this data business users have near real-time access which assists in regulatory reporting and event management. The architecture allows for swift disconnection from the corporate domain where required in order to protect the operational assets.

As previously discussed, sites that were upgraded as part of the capital programme were classified as small, medium or large systems. This classification was not solely based on I/O count, although that did influence part of the design, but more on the criticality of the treatment processes. An example of a complex sewage treatment system may include processes such as thermal hydrolysis plant (THP) with high throughput to a combined heating and power (CHP) systems and where this process generates and exports electrical energy to the grid. An example of a complex process in clean water applications could include ozone generation (where Oxygen O<sup>2</sup> is converted in Ozone O<sup>3</sup> using high voltage chambers). These processes may not have large amounts of I/O or be on sites with a lot of other process areas, but by the nature of their complexity and need for resilience, a large architecture would have been selected.

#### 4.3.1 Computing Resource Architecture

All new systems were deployed using a read-only domain controller (RODC), which was a copy of the master active directory domain controller (DC) and enabled system commissioning prior to master domain integration. The active directory DC was deployed within a high availability, on premise, datacentre and serves as the management agent for the connected operational assets active directory domain. This domain serves all computing resources deployed in levels 1, 2 and 3 of the Purdue model and is segregated from the corporate IT domain, via security protocols and policy. A Linux virtual management agent (vMA) was deployed to integrate the uninterruptible power supply (UPS) status commands and control the hypervisor's safe shutdown.

As per Figure 4-4, small site architecture comprised a single physical server, virtual machine and operating system. This served as an all-inclusive repository, application, historian and terminal server. NOTE: upon migration to the master DC, the RODC was switched off and became redundant.

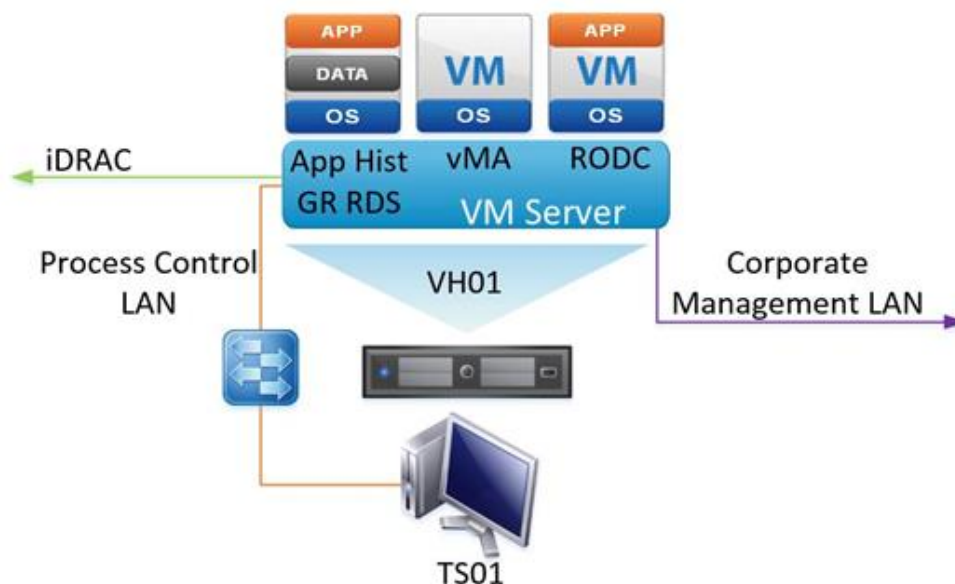

Figure 4-4 Small System Computational Architecture [97]

Medium site architectures, as per Figure 4-5 were deployed across a pair of dual redundant virtual application / historian servers and a single terminal server. These all ran on a single physical host. Again, the RODC and vMA are included as per the methodology discussed for a small architecture.

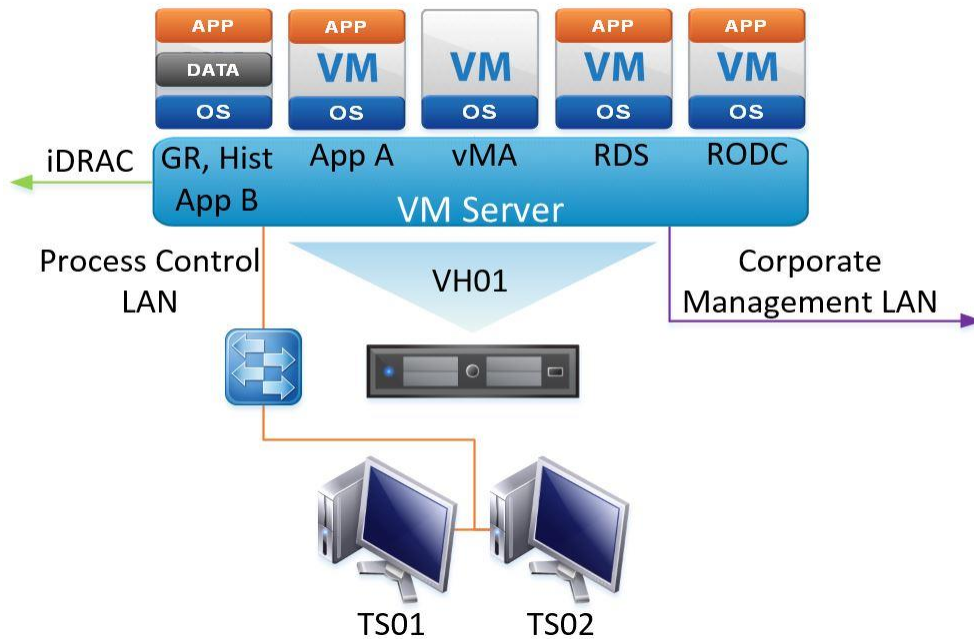

Figure 4-5 Medium System Computational Architecture [97]

Large sites, as per Figure 4-6 consist of an independent standalone GRNode, physically dual redundant application servers and a pair of physically redundant terminal servers. The data historian is also physically dual redundant with the primary historian on the GRNode. The backup historian has its own guest operating system located on the other virtual host.

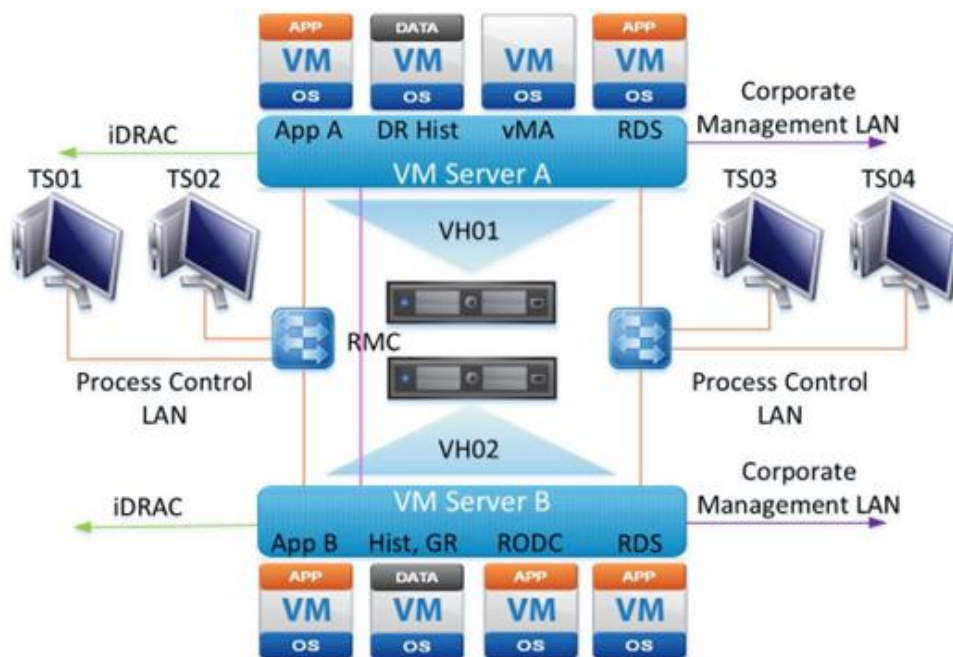

Figure 4-6 Large System Computational Architecture [97]

The following acronyms are used within the previous three figures and are detailed below for ease of reference [97].

- VM = Virtual Machine
- OS = Operating System
- APP = Application Component
- DATA = Historian Component
- vMA = Virtual Management Agent (Linux)
- iDRAC = Integrated Dell Remote Access
- GR or GRNode = Galaxy Repository (Wonderware ArchestrA central configuration area)
- TS = Terminal Server
- LAN = Local Area Network
- RDS = Remote Desktop Session
- VH = Virtual Host
- RODC = Read Only Domain Controller

#### *4.3.2 Application Resource Architecture*

Within the configuration front end of the new SCADA system resides domain-specific application object templates. As a basic example, these object templates provide repeatable coding and graphical symbols for field assets including pumps, valves, pressure and flow transducers. The configuration environment also houses integration object templates used to poll data from an OPC server and provides the linkage for animation to any instantiated application object or symbol. For advanced coding, the access and use of a configuration back end, which comprises an add-on to Microsoft's Visual Studio C#, enabled project software developers to create custom application objects. This was further leveraged to provide a water company-specific framework and create water application object templates.

#### *4.3.3 System Security*

The infrequent and asynchronous application of system anti-virus (AV) and end-point security patches within mission-critical SCADA systems, including standard Microsoft product updates, introduces levels of vulnerability and real-time constraints, which the research further confirmed from [112]. The automation of updates had previously proven onerous and, on occasion, presented intolerable downtimes and delays to production processes and networks, where a patch crashed the system and

application. As part of the standardisation of the SCADA estate, the capital programme ensured all newly deployed computational resource was available and could be owned and maintained by the company's incumbent system administration team. This was achieved using the Windows Server Update Services (WSUS) patch management software tool. Deploying in this way sets a framework for systematic, accountable, and documented processes, further enabling the management of any exposure to critical vulnerabilities through a near real-time patching, also presented by [113]. This was completed as and when a patch was released, tested offline in a development environment and certified as fit for purpose.

#### **4.4 Standardised SCADA Platform**

To achieve a modular, standardised SCADA platform, the strategy selected by the programme team, whom the author was project member of, was to adopt elements from a selection of existing SCADA and asset standard naming conventions. This also sought to include some of the pre-existing graphics and symbols and merge them into a common template library for application to any instantiated system. As previously discussed, the existing SCADA estate had matured over time, organically and in several different directions depending on who had been engaged to upgrade a target system. This had, over time, resulted in a multitude of differences in application from site to site.

##### **4.4.1 Symbols**

Within a typical SCADA display, which includes symbol and animations, the construction and arrangement is completed so as to visually replicate a site process piping and instrumentation diagram (P&ID). The most common symbols include pumps, valves, and analogue and digital instrument displays. However, the specifics of a water company's operation will also include some non-standard assets that need symbols and animation. This can include assets such as filter screens, aeration systems (air blowers or surface aerators), grit removal plant, liquid chemical or gas dosing systems, ozone generation, filtration systems and dewatering equipment.

To ensure resilience within the workforce, as well as further ensuring skills and competence, operations staff are trained to operate and maintain systems and processes across multiple sites and regions. Experienced workforce members may start being required cross-discipline, which will see them covering clean and wastewater applications. If a team member from one area within Thames Water Utilities Ltd had familiarity with their SCADA systems interface, then it may become

confusing to deploy to another site or region where the site SCADA has been constructed using a different application and rule base. Further, due to the organic growth of the SCADA install base within a typical water utility, which will see sites developed and upgraded at different times and with different products, the visualisation to date has not always been consistent.

These differences will invariably introduce risk to the operation as unfamiliarity poses a higher risk of executing an incorrect process command. If left, this sporadic use of non-standardised architectures would almost certainly command an increase in the level of training required to keep operations staff familiar with all the variants of the system. This, in turn would require significant operational expenditure to cover; therefore, the further justification of a standardised modular SCADA estate adopted across all site types is made.

#### 4.4.2 Dynamic Symbols

A dynamic symbol will provide a graphical representation of a field asset and its change in operational state; for example, running is one colour, stopped another. A pump that has become faulty will be animated with a red flashing box around it. Some examples of legacy symbols and how they differ are shown in Figure 4-7.

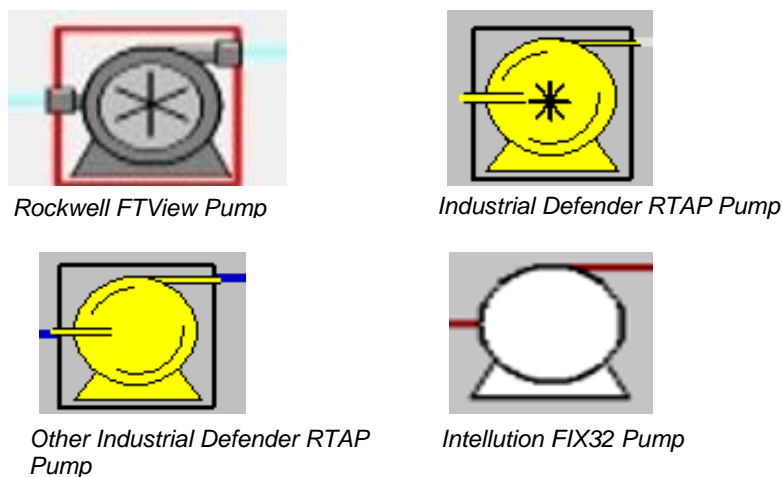
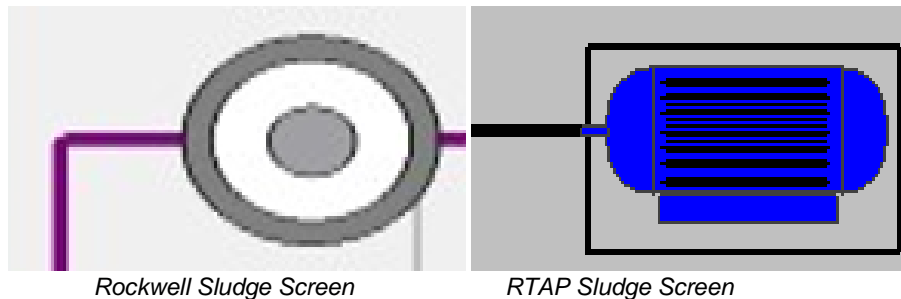

**Figure 4-7 Examples of legacy pump symbols [97]**

At first glance, the symbols presented in Figure 4-7 appear similar in appearance. However, with the top two symbols, there is a star graphic located within the centre of the pump casing, which could be mistakenly read as a blower or fan symbol to an operator who is unfamiliar with the site or who has similar graphics for blowers and fans on their site.



Figure 4-8 shows an example of how different some graphical symbols for the same process type can be, in this case both are trying to animate a sludge screen plant. On the left a combination of circles represent a surplus activated sludge (SAS) screening system, on the left an electric motor graphic also animates a SAS screen. The physical plant at both sites will comprise similar technology and operation, which suggests that, for an operational team to deploy cross-site they should also comprise the same graphical symbols when displayed on SCADA.



**Figure 4-8 Examples of legacy screen symbols [97]**

The deployment of a suite of standard symbols and configuration objects has proven to govern consistency across all sites within the scope of the upgrade programme. The developed library comprises symbols and configuration object templates, capturing the company’s waste and water treatment processes. An example of a pump and blower symbol are shown in Figure 4-9.





**Figure 4-9 Example of new pump and blower symbols [97]**

#### 4.4.3 Colouring the process

The standardisation of symbol libraries and static process lines (the lines that represent interconnecting pipes between process asset) include the coloration for each process type. The colour scheme is defined by the company’s internal asset standards which also details the required RGB coordinates for applying within the SCADA application. A sample of asset standard colours from the company are shown in Table 4-1.

**Table 4-1 Example Asset Standard Colours for Process Streams**

Process Area	Colour	Colour	R	G	B
Air / Oxygen		Lavender	204	153	255
Digesting sludge		Brown	153	51	0
Ozone		Pink	255	0	255
RAS / SAS		Violet	128	0	128
Sludge screenings		Lime	153	204	0
Storm water		Green	0	128	0
Polyelectrolyte		Turquoise	0	255	255
11KV		Signal Red	187	64	57
6.6KV		Blue	0	0	255
3.3KV		Dark Violet	109	79	115
2.2KV		Magenta	102	0	51
< 1KV		Black	0	0	0

#### 4.4.4 Object Templates

Across Thames Water Utilities Ltd exist hundreds and sometimes thousands of assets that comprise very similar operational configurations and the same hardware. Primary examples include pumps, valves, flow and level instrumentation etc. Commercial and procurement strategies dictate standardisation through the use of framework agreements, which drive competitive rates as well as ensuring any upgrade of old or faulty units can be achieved through a familiarised workforce, optimising the resource effort required. This approach is now further mandated, via asset standards, in the development of SCADA database objects.

The Aveva Wonderware SCADA package used for the company's upgrade comprised a developer back-end interface ArchestrA Object Toolkit (AOT). AOT is a Microsoft Visual Studio add-on and allows developers to create their own application specific object templates in the C# language.

A set of six parent level application object templates were deployed. These were designed to cover the majority of all available plant items across the company's asset base. Listed as follows:

- \$STR – Starter Device - Pumps, motors, conveyors, screens etc.
- \$POS – Positioner - Folomatic valves, Penstocks etc.
- \$AI – Analogue Instrument - Any device that provides variable feedback. Level, pressure, flow, temperature etc.
- \$DI – Digital Instrument - A single instrument such as a level or pressure switch with a Boolean output.

- \$Ctrl – Blank canvas - This was created to allow SCADA engineers to create bespoke control objects that otherwise would not be configurable via any of the above templates.
- \$UI - Blank canvas - This was created to allow SCADA engineers to create bespoke user interfaces, as long as there was no associated control.

\$AI and \$DI templates were created so a singular analogue or digital signal source could be instantiated respectively. Examples include a single pressure transmitter or a wet well level for the \$AI. For \$DI, this might include devices such as a float switch in a well that generates a Boolean signal on state change. These templates were not used for larger plant items. I.e., a pumps integral over-pressure cut-out signal would be contained within the \$STR device. A sluice gate penstocks position signal would be an extension attribute within a \$POS object.

The AOT enabled the project development team to create a suite of complex custom object templates representing specific water assets and equipment.

Once available, a template can be instantiated as many times as required. An instance is a child from the parent object and therefore inherits all configuration and runtime code, which not only governs the mechanisms the supply chain uses for configuring new systems but also permits a streamlined approach in creating multiple assets. For example, a site has 20 rapid gravity filters (RGFs). Once the parent object template for an RGF drain down pump has been stood-up (which would be a derivative of the \$STR template), the 20 instances can be created. The newly created instances are exact copies that inherit the same configurable attributes the parent holds. A configuration engineer, therefore, is only required to map the I/O register via the integration object tag (e.g., an OPC data point). Any change to the parent object template will propagate to all child instances, eliminating the need for individual updates.

#### *4.4.5 Asset Tagging*

This section proposes concerns with existing legacy asset tagging and some of the issues from a non-standardised approach. The research then further proposes how Thames Water Utilities Ltd.'s capital programme addressed this through standardisation.

#### 4.4.5.1 Legacy Concerns

Historically, the use of out-of-date standards, non-compliance with any associated standard and the limited processes to manage governance has led to suppliers interpreting and applying, at free will, the tags in the site's SCADA database objects. A nonstandard approach makes data-mining a near-impossible task by the business analysts and data scientists who receive the data at the point they hit the corporate tier 2 historian. Correlation with a common framework (in this case, an asset tagging standard) is unachievable due to the variance in applied asset tagging across the estate.

For example, an aeration outlet penstock that controls the outlet flow from an oxidation ditch to a secondary filtration plant may be tagged at one site as; **AER1VLV1**, with the exact same asset type at another site being tagged as **OX1MV1**. At a local level, this generally does not create too many issues as the operations team understand what each tag relates to. Further, when presented on a SCADA mimic, which is a replica of the P&ID then it is easy to infer what the tag represents as its presented in combination with the replica P&ID symbols. The issues stem when presented to non-operational users (with no familiarity of site) within a database dump at the tier 2 historian layer. It is at this point the ambiguity between varied tag codes creates data-mining constraints.

Note: When data are presented at a tier 2 historian for analysis purposes, the teams inspecting the data will not have the benefit of a SCADA mimic and / or replica P&ID. The data are presented in traditional column and row format.

Another constraint with ungoverned tagging means that tag string lengths are not always the same. This will inhibit the standardisation of any logical query syntax from being applied across the dataset. By taking the previous example of the two aeration outlet penstocks above and prefixing the site functional location code (FLOC) to each tag, a simple inspection rule to determine the penstocks process group and ID would not be a simple automation rule.

- **SITE1NAME\_AER1VLV1**
- **SITE2NAME\_OX1MV1**

The above data tags represent the two aeration penstock valves at two separate wastewater sites. The colour codes are detailed as follows.

- **Functional Location Code – Unique Site Identifier**

- Process Code- in this example – Raw Water
- Process numeric code
- Plant code – In this example - Valves
- Plant numeric code

A simple excel query that inspected all aeration outlet penstocks in process 1 for test site 1 would be written as =MID('Cell-Ref',14,1). The same query for test site 2 however, would need to be written as =MID('Cell-Ref',13,1). This creates an issue as autonomous extraction querying using string length and structure for data mining is not possible and thus introduces additional onerous effort when trying to interrogate the data.

#### **4.4.5.2 Standardised Asset Tagging**

Under the programme to upgrade the target SCADA systems, the application of a current asset tagging standard was mandated. This standard governed the use of process, plant and signal codes.

By mandating this approach provided clear statements of ownership and a rule set for constructing the formal identifiers. All new codes were used for the identification of operational processes, plant, and signal data. The new schema, taken from [114], permitted visibility of the following;

- The area / site
- The main process and number
- The plant / instrument and number
- The signal

All assets captured during the capital SCADA upgrade programme were assigned a fixed, governed, process related unique identifier (asset tag). These tags were assembled as follows:

- Functional location code (FLOC)
- Process area code
- Plant / instrument code

Note: As a general rule, and to reduce the amount of text displayed on a SCADA screen, the FLOC codes were omitted from the graphical symbols. Across a small

selection of sites, however, where ambiguity resulted, these were reinstated. An example would include two sites that share a single reservoir or borehole.

FLOC codes are utilised across the company and provide the identifier that determines the physical site in which an asset is installed. FLOCs are used across all corporate systems, including SAP™ business objects.

In line with the company's asset tagging standard, all plant items associated with process units were given identifiers using the following format:

- FFFFFFFF\_PPP##CC\*\*
  - FFFFFFFF = Eight-character FLOC code,
  - PPP = Three-character process code,
  - ## = Two-character process numeric code
  - CC = Two-character plant code
  - \*\* = Two-character plant numeric code.

By taking the previous aeration penstock valves example, the application of the standardised asset tagging yields the following result.

- SITE1NME\_AER01MV01
- SITE2NME\_AER01MV01

Applying the standard consistently across all assets has ensured that the data now align across the company's estate.

In summary, the standardisation of asset tagging, and process colouring has resulted in a common data and information platform, which in turn has empowered site operators, regardless of site, in understanding what is presented on screen, thus significantly reducing the risk of ambiguity from site to site through non-standard constructs. It has further liberated the data in the tier 2 corporate historians for inspection and analysis by other business users.

#### **4.5 Human Factors**

With any transformation and change programme within a large corporation, including replacing an operational SCADA system, significant effort and investment are required to adopt business-as-usual production, including operator training and this was also witnessed within the Thames Water Utilities Ltd deployment.

As both the new and old process mimics followed the site's P&ID, there was limited difference in how the new screens appeared. As a result, they were accepted by the operation without concern. However, the software product used for visualising data trends took a wholesale shift in terms of the graphical user interface (GUI), including colouration. As a result, extensive training was required in order to familiarise the operation with the new system.

#### 4.5.1 *System Access*

As previously discussed, the new SCADA systems were built upon a Microsoft Active Directory and all computational resources were migrated into the separate SCADA domain.

This approach introduced user authentication and provided enhanced system security. It was done to protect the asset base by enabling event handling and traceability. All new SCADA users were provided with their own active directory SCADA account, which had to be used to authenticate onto the network, computing resources and access the SCADA applications.

Strategically and based upon an ever-growing desire for improved systems security, this approach was an approved way forward. At an operational level, it presented challenges.

The process for accessing a SCADA application now required a user to log into the local client workstation, the first checkpoint requiring entering a username and password. Once complete, the second step requires a remote desktop session into one of the application terminal servers; this is the second point in which a user must enter their username and password. From the terminal server session, the application executable can be called.

The time taken to log on to the application varied as a result of an operator's computer literacy skills. With a proficient user, it took approx. 1-2 minutes to be in an active SCADA session, including all operating system boot times and application, start up.

The previously installed legacy SCADA systems were not domain integrated, and authentication onto an operating system and domain were not required. The system typically comprised one of two accounts:

- Default – Operator

- Admin - Engineer

Here an operator account could navigate the system and manipulate process variables, set points, pumps start etc. The engineer account was for anyone needing access to the configuration area for maintaining, adding, modifying functionality etc.

These systems were on 24 / 7 and always logged into with the default operator account. No inactivity timeouts were present, which meant anybody could enter a control room (other people go into control rooms, not just the skilled operators), touch the mouse pointer, which took the computer out of sleep mode, and the application was immediately available.

Engagement with the operation led to a deeper knowledge of the main issues. It found the change in approach was not welcomed locally and was receiving pushback, as it was believed to be an unacceptable increase in time required to gain access to the SCADA application and determine what was happening on site. This risk was further exacerbated during any potential event conditions (asset failures, pollution, weather deluges etc.). Furthermore, policy had established an automatic user log off after a 15-minute period of inactivity on the application.

Upon review of these risks and the concerns raised within section 4.2, which details the varying degrees of reliance upon SCADA across the estate, there was an acceptance that the domain policy required attention for the shift controllers who operate their sites 24 / 7 and who are heavily reliant upon the SCADA application for this.

To address this concern, a critical process control user was created within the active directory, including a revised policy for this user. Where a 24-hour manned site comprising a secure control room existed, a 12-hour account was permitted, with qualifying users being approved to use it. The new account came with a two-hour inactivity screen saver that only required a single password sign on to get back into the application. This eliminated the need to repeatedly login to the workstation client device and then on to the terminal server. All other sites were left as per the original design, and further training was offered to those operators who required it.

#### *4.5.2 Adoption of revised Tagging Concerns*

One of the steps in migrating the old SCADA systems database to new one included an extraction, analysis and conversion process. This was due to the aforementioned



mandate that stated all new asset tags must adhere to the current standard. In certain scenarios this introduced ambiguity regarding asset labelling, pre- and post-upgrade. As per the example in section 4.4.5.2 AER1VLV1 became AER01MV01.

A particularly extreme example included a valve's plant ID that went from PV30 to MV06, which completely deviated from the tag ID deployed in the field and against the P&ID diagram.

One mitigation step taken to try and reduce any risk through ambiguity used the dynamic symbols associated with faceplates / popups. When called, the faceplate / popup provided additional information tabs, which in turn displayed the original asset tag, for inspection where required. Further, a lookup utility was deployed and enabled users to search for an equivalent legacy tag by using the new ID. This also detailed any associated mimics where the asset is presented.

Upon deployment of this mitigation, senior company health & safety experts and operational production managers were consulted. It was ruled that these steps were inappropriate in mitigating the risk as the primary concern on the introduction of new tagging structures still remained and were the primary identifier, visible on the SCADA display. The decision was made based upon control room behaviours during event / crisis management (any event that introduces a heightened sense of urgency for a shift controller). The need for information to be available immediately, and not through mitigation measures, was a mandatory requirement.

The decision impacted the programmes delivery and ultimately led to an increase in unforeseen costs. This was alleviated by the new system adopting object-orientated programming structures, which included symbol templating and hierarchies. This meant that only a relatively minor change was required in the parent symbol, which introduced small script to point the GUI at the legacy tag metadata field, as opposed to the new asset tag. Some additional database work was also required to prefix the legacy tag to all trend and alarm descriptions, ensuring consistency remained.

Upon completion, the system was set up such that operational users would still have reference to the original legacy tags on screen; however, in the background and to keep a consistent identifier up through the Purdue stack, the new tag was employed.

#### 4.5.3 *Adoption of overall system concerns*

There is an increasing awareness among the control room community and the wider leadership teams within the water companies regarding the importance of human factors. This awareness has been heightened by a realisation that incidents and events are rarely the result of isolated technical failures, which was also discussed in [115].

A key component in the acceptance of systems when delivering new operational technologies are the individuals who will be tasked with using them. A water company's asset base will likely span several counties and districts comprising a mixture of large urban areas and cities as well as rural towns and villages. The diversity of this broad spectrum introduces further variance in user demographics, which in turn does not allow for an attitude that caters for a one-size-fits-all model, especially when deploying and requiring user acceptance of new technology.

From an organisational perspective, there are strong correlations between the resistance to change and the implementations success, which has been experienced during the SCADA upgrade programme discussed in this chapter as well as other industries as per research shown by [116]. The learnings from the research completed by the author include sensitive management, at both an individual and wider group level, which must always be considered when planning any large change to the operations technology stack. Engagement should always be sought as early as possible and be fully inclusive of all potential end users.

The behaviour within a SCADA control room, and the output performance is like any other area of business; it is a function of its own environment. Within the construction industry, the use of behavioural techniques for improving safety is becoming more commonplace. It primarily focuses on the behaviours that lead to incidents and injuries. However, the research suggests that analysis of behaviour related to technological changes in the workplace environment could lead to a better understanding of how integration could be delivered more effectively and without such resistance to change [97]. Human factors must be factored into any major operational technology change.

This research further suggests that by standardising SCADA database structures assists in liberating the data and generates greater value from this data across the Purdue stack. It does so by deploying scalable, transferable information models that interact seamlessly across all business units. Further, it reduces analytical resource

efforts by enabling templated query structures, which will thus enable future asset optimisation strategies to integrate more robustly.

#### **4.6 Summary**

Water company control room communities and leadership teams are increasingly recognising the importance of human factors in incidents and events. Implementing new operational technologies requires considering the individuals tasked with using them, considering the diverse user demographics across different areas. Resistance to change significantly affects implementation success, as observed in water companies and other industries. Sensitivity in managing individuals and groups, early engagement, and inclusivity are vital for successful technology deployment.

The behaviour and performance within a SCADA control room are influenced by the environment, similar to other business sectors. Analysing behaviour related to technological changes can enhance integration and reduce resistance to change. Human factors must be considered in major operational technology changes.

Standardising SCADA database structures liberates and maximises the value of data across the Purdue stack, benefiting all business units. It enables scalable, transferable information models and reduces analytical resource efforts through templated query structures. This facilitates future asset optimisation strategies.

# Chapter 5

## Catchment Selection and Model Reconstruction

Chapter four proposed the common object templating within a SCADA system, which would enable the researcher to deploy a scalable tooling set following a successful optimisation trial. The next stage in the research was to identify a suitable physical catchment and associated assets for inspection.

In this chapter the author proposes a novel approach to identify a suitable wastewater network for study using K-Means clustering. Following the identification of the target network the discussion moves into how the identified network was surveyed by the author and how this enabled the hydraulic model to be improved by reconstructing the configuration with real-world variables taken from each site. This included the construction of new hydraulic components by the author, not previously present within the model, including all rising main pipes and their characteristics.

This was completed in order to determine electrical energy reporting and, in the opinion of the author, has not been completed before, thus proposing a novel approach to model configuration. Before deploying any new control strategy within the operational system, the associated hydraulic models will require comprehensive analysis to determine if they are suitable for providing asset owners with confidence in prediction for any of the intended control changes. This chapter proposes

### ***5.1 Selecting a Catchment***

Following the anticipated positive optimisation results, the research intends to adopt and deploy the control strategies onto a live catchment. As a result, the upfront catchment selection, prior to modelling, needed an awareness of capital cost for delivery, which in turn focused on wastewater pumping sites that had already been fitted with an EPSM enhanced telemetry system.

By selecting a catchment with as many pre-installed EPSMs as possible it was determined that this would likely reduce the investment required for physical deployment, as the majority of pumping systems would already be equipped with all the required electrical and telemetry components, thus enabling any catchment wide energy control to be deployed without wholesale asset upgrade across the patch.

The catchment to be selected as part of this research was to come from within a water company's estate, where during the 2010-2015 investment period (AMP5), approximately 230 (out of 4,700) legacy SPS telemetry outstations were replaced with devices equipped for remote control functionality. Furthermore, electrical modifications within the SPS pump motor starters integrated start / stop control from the telemetry device. However, these upgraded SPS systems were only commissioned using the basic control system approach, i.e., level up start pump, level down stop pump.

The units replaced during AMP5 were done based on those most at risk of failure. As a result, there were a number of geographically disparate control system upgrades distributed across the south and southeast of England, with no one single catchment fully equipped. In order to identify the 'best fit' for any future production trials (following a positive output of this research), the catchment with the highest number of upgraded SPSs needed identifying.

Organic growth of sewer networks over time has meant that, quite often catchment data pertaining to telemetry assets are unavailable. As a result, the research only had latitudinal and longitudinal coordinates for each upgraded SPS. Based on this, it was concluded that these coordinates would require grouping in a two-dimensional space and, in turn laid over the top of an ordnance map. Subsequently, in order to identify the most suitable catchment for trial, it was decided the 230 already converted devices would be grouped by clustering.

## ***5.2 Use of Clustering to Assist Identification***

There were several clustering options available, and this research investigated a selection of these, including:

- Hierarchical, presented by Tang and Zhu [117] and [118].
- Density-based, discussed within literature from Wu and Wilamowski [119] and Wang and Huang [120].
- Partition-based from research conducted by Wang, Zhu [121].
- K-Means, from several authors, including Hua, Lau [122], Xu, Qu [123] and [124], also including a variant called hierarchical k-means presented by Xu, Chiang [125].

It was concluded that any of the above-mentioned techniques would have been suitable, however, based on the low complexity of the data set being inspected, and

due to the ease of application, it was decided that the Matlab K-Means++ algorithm would be used. The algorithm was employed to take each wastewater pumping stations latitude and longitude coordinate (as an X, Y graph plot) and create cluster groups within this design space.

The K-Means++ uses a heuristic to find centroid seeds for the standard K-Means clustering function (also referred to as Lloyd's algorithm) [126]. In this case the geospatial centre of the waste catchments forms the centroids. According to Arthur and Vassilvitskii [127] and from further review of the literature contained within The MathWorks [126] Matlab software; K-Means++ improves the running time of the standard K-Means (Lloyd's) algorithm, and the quality of the final solution. It does this by first taking one centre  $c_1$ , which is chosen uniformly at random from  $X$  (the latitude / longitude dataset), and secondly it takes a new centre  $c_i$ , choosing  $x \in X$  with probability:

$$\frac{D(x)^2}{\sum_{x \in X} D(x)^2} \quad (5.1)$$

where  $D(x)$  denotes the shortest distance from a coordinate to an already chosen centre. This is repeated until all centroids  $k$  have been taken and then continues with the standard K-Means algorithm as follows. Randomly choose an initial number of  $n$  clusters:

$$C = c_1, c_2, \dots, c_n, \quad (5.2)$$

Li, Pye [128] describe that as there are no labels indicating the assignments of pathways to individual clusters for K-Means, it is challenging for the algorithm to determine the optimal number of clusters. Therefore, a predefined number of clusters is required as an input parameter. For the wastewater catchments in this research this random number was arbitrarily set at  $n = 100$ . The number 100 was chosen as it was judged by the author to be high enough to determine an overly granular distribution across within the design space.

Then, for every  $i \in (1, \dots, n)$  the cluster  $C_i$  was set to be the range of points in the latitude / longitude dataset,  $X$  that were closer to  $c_i$  when compared to  $c_j$  for all  $j \neq i$ . Then, for every  $i \in (1, \dots, n)$ , set the cluster  $c_i$  to be the centre of all points in  $C_i$  and repeat until  $C$  no longer changes [127].

$$c_i = \frac{1}{C_i} \sum_{x \in C_i} x \quad (5.3)$$

After running the Matlab K-Means++ function across the 230 coordinates with an initial random  $n = 100$  it was proven that the clusters offered were far too granular and multiple clusters within single catchments were being identified. This was concluded by converting the cluster results into a keyhole-marked-up-language (.kml) file which was opened in Google Earth™ and inspected against a GIS catchment overlay. Manual tuning of the initial random variable eventually led to the optimal value being set to  $n = 20$ .

Figure 5-1 shows the initial graphical output of the 230 sites in their respective catchment clusters. Using the additional Matlab silhouette function on the calculated cluster data, a measure of how similar a coordinate is to other coordinates within its own cluster is obtained, when compared to coordinates in other clusters. The silhouette is calculated using:

$$S_i = \frac{b_i - a_i}{\max(a_i, b_i)} \quad (5.4)$$

where  $a_i$  is the average distance from the  $i^{th}$  coordinate to all other coordinates in the same cluster as  $i$ , and  $b_i$  is the minimum average distance from the  $i^{th}$  coordinate to coordinates in a different cluster, minimized over clusters [129, 130].

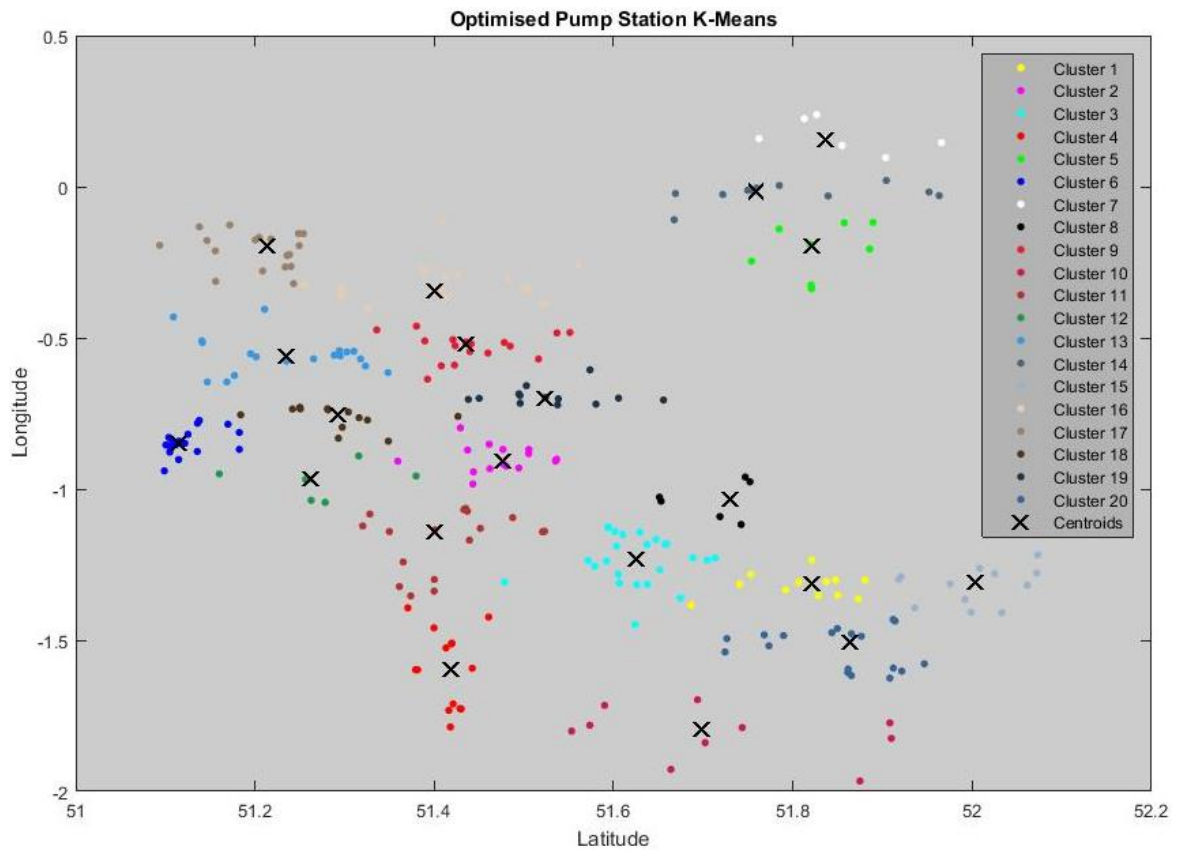

Figure 5-2 Latitude/Longitude cluster data on the optimised pump stations using K-Means

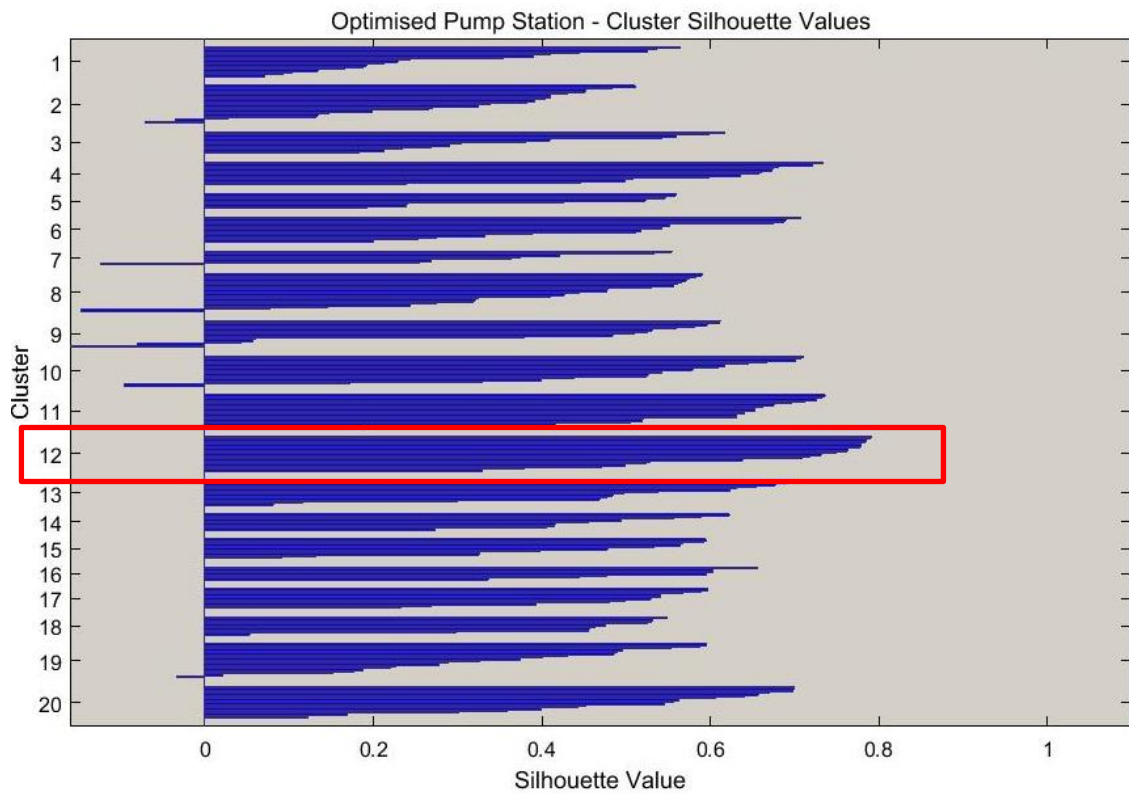

Figure 5-1 Cluster silhouette values



Figure 5-2 is the resulting silhouette plot for the 20 clusters created with the K-Means++ algorithm. Upon inspection, clusters 10, 11 and 12 were all seen to show the most positive relationships within their own cluster both in terms of the silhouette value being greater than 0.7 and also the thickness of the silhouette function before tapering, which indicates more of the datapoints within the cluster are conforming to the rule. This is concluded based on silhouette value ranges from -1 to +1, with a high silhouette value indicating that  $i$  is well-matched to its own cluster, and poorly-matched to neighboring clusters [129, 130].

The three clusters were inspected on a map overlay with the highest density cluster against an overall catchment ratio of new-to-old telemetry devices being located within cluster 12. The outcome from this analysis was that a wastewater catchment called Bordon, a small town in Hampshire England, comprising 33 SPS's would form the basis of the trial.

Appendix 1 contains all Matlab code for the above processes. Also contained in appendix 1 are the KML output scripts, which were used to generate the Google Earth overlay.

### 5.3 The Bordon Wastewater Catchment

The Bordon wastewater catchment resides in the East Hampshire district of Hampshire, England. It lies in the interior of the royal Woolmer Forest, about 5.4 miles (8.7 km) southeast of Alton, shown in Figure 5-3.

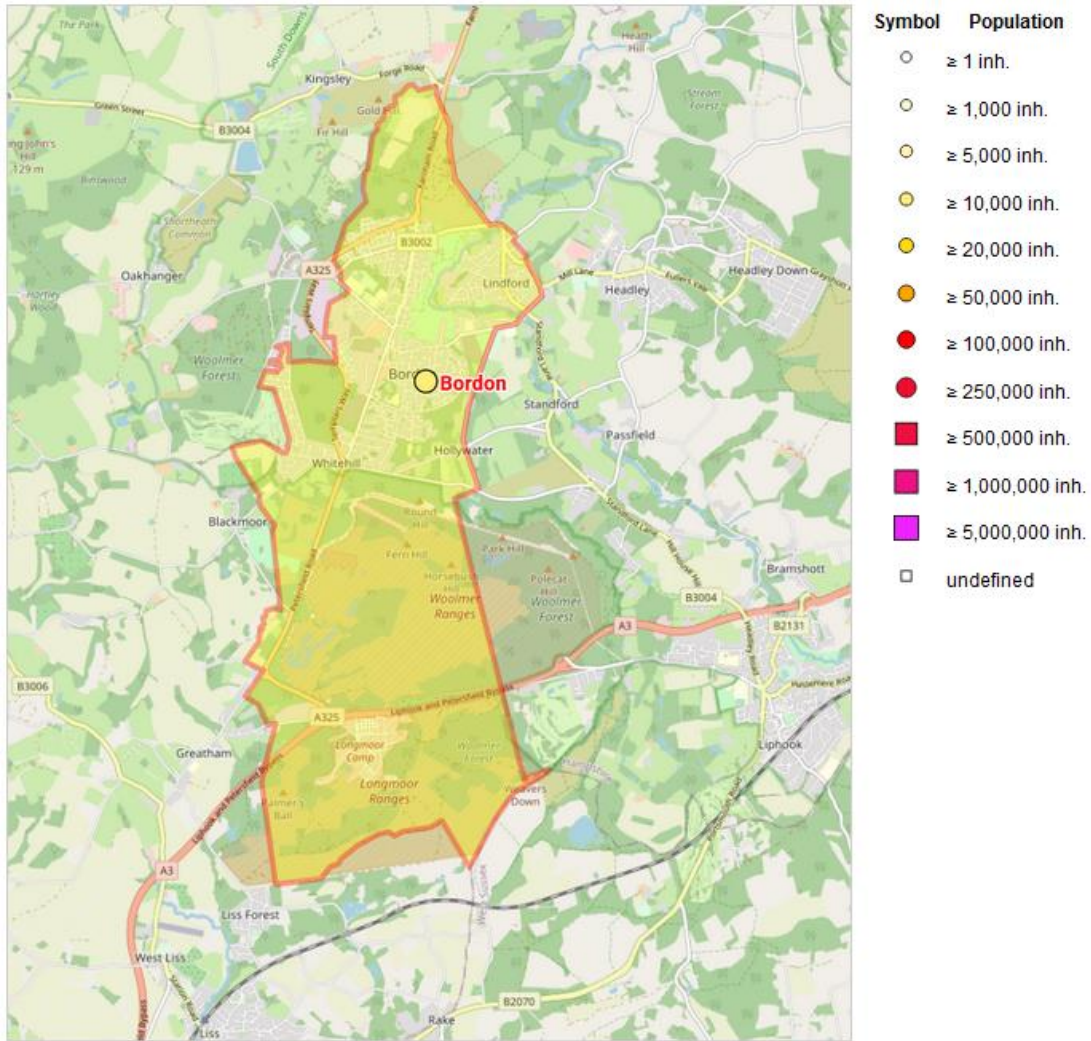

Figure 5-3 Bordon map with population statistics [131]

There are 33 wastewater pumping stations distributed within the catchment at various points. These pumping stations are used to lift wastewater over rising areas of land where the use of gravity is not an option. Through the combination of these pumped rising mains and the remaining gravity system, all flow is diverted into the receiving treatment works at Bordon Sewage Treatment Works. Table 5-1 is the site list for the 33 pumping stations.

**Table 5-1 Bordon wastewater pumping station list**

FLOC	SAP_Desc	OD_Region	OD_Sub_Team	WC_Desc	OD_Area
APOLP1ZZ	Apollo Drive (Bordon) SPS	South	West A	MAINTENANCE AOPT STH PUMP (SOUTH)	West
ARFOP1ZZ	Arford SPS	South	West A	MAINTENANCE AOPT STH PUMP (SOUTH)	West
ASHGP1ZZ	Ash Grove (Liphook) SPS	South	West A	MAINTENANCE AOPT STH PUMP (SOUTH)	West
BORDS1ZZ	Bordon STW	Waste Ops	West	Farnham	South
BRAMP8ZZ	Bramshott Court (Passfield) SPS	South	West A	MAINTENANCE AOPT STH PUMP (SOUTH)	West
CHALP2ZZ	Chalet Hill (Bordon) SPS	South	West A	MAINTENANCE AOPT STH PUMP (SOUTH)	West
CHAPP1ZZ	Chapel Gardens (Lindford) SPS	South	West A	MAINTENANCE AOPT STH PUMP (SOUTH)	West
CHURP7ZZ	Churt SPS	South	West A	MAINTENANCE AOPT STH PUMP (SOUTH)	West
CONFP1ZZ	Conford SPS	South	West A	MAINTENANCE AOPT STH PUMP (SOUTH)	West
CYPRP1ZZ	Cypress Road (Bordon) SPS	South	West A	MAINTENANCE AOPT STH PUMP (SOUTH)	West
GRIGP2ZZ	Griggs Green (Liphook) SPS	South	West A	MAINTENANCE AOPT STH PUMP (SOUTH)	West
HAMIP1ZZ	Hamilton Close (Bordon) SPS	South	West A	MAINTENANCE AOPT STH PUMP (SOUTH)	West
HEADP1ZZ	Headley Mill (Bordon) SPS	South	West A	MAINTENANCE AOPT STH PUMP (SOUTH)	West
HEATP8ZZ	Heatherlands (Headley Down) SPS	South	West A	MAINTENANCE AOPT STH PUMP (SOUTH)	West
HOGMP2ZZ	Hogmoor Road (Whitehill) SPS	South	West A	MAINTENANCE AOPT STH PUMP (SOUTH)	West
KINGPHZZ	Kingsley Common (Bordon) SPS	South	West A	MAINTENANCE AOPT STH PUMP (SOUTH)	West
LARCP3ZZ	Larch Close (Liphook) SPS	South	West A	MAINTENANCE AOPT STH PUMP (SOUTH)	West
LIONP2ZZ	Lions Field (Oakhanger) SPS	South	West A	MAINTENANCE AOPT STH PUMP (SOUTH)	West
MALTP3ZZ	Malthouse Meadows (Liphook) SPS	South	West A	MAINTENANCE AOPT STH PUMP (SOUTH)	West
MAPLP0ZZ	Maple Leaf Drive (Bordon) SPS	South	West A	MAINTENANCE AOPT STH PUMP (SOUTH)	West
MARSP5ZZ	Marsh Close (Bordon) SPS	South	West A	MAINTENANCE AOPT STH PUMP (SOUTH)	West
MEADP8ZZ	The Meadows (Churt) SPS	South	West A	MAINTENANCE AOPT STH PUMP (SOUTH)	West
MONUP0ZZ	Monument Chase (Whitehill) SPS	South	West A	MAINTENANCE AOPT STH PUMP (SOUTH)	West
OAKHP1ZZ	Oakhanger SPS	South	West A	MAINTENANCE AOPT STH PUMP (SOUTH)	West
PASSP1ZZ	Passfield (Bramshott) SPS	South	West A	MAINTENANCE AOPT STH PUMP (SOUTH)	West
ROYAP4ZZ	Royal Drive (Bordon) SPS	South	West A	MAINTENANCE AOPT STH PUMP (SOUTH)	West
STONP8ZZ	Stoney Bottom (Grayshott) SPS	South	West A	MAINTENANCE AOPT STH PUMP (SOUTH)	West

TULLP1ZZ	Tulls Lane (Standford) SPS	South	West A	MAINTENANCE AOPT STH PUMP (SOUTH)	West
TUNBP2ZZ	Tunbridge Lane (Bramshott) SPS	South	West A	MAINTENANCE AOPT STH PUMP (SOUTH)	West
WALLP1ZZ	Walldown Road (Whitehill) SPS	South	West A	MAINTENANCE AOPT STH PUMP (SOUTH)	West
WARRP2ZZ	Warren Close (Whitehill) SPS	South	West A	MAINTENANCE AOPT STH PUMP (SOUTH)	West
WESTPAZZ	Western (Bordon) SPS	South	West A	MAINTENANCE AOPT STH PUMP (SOUTH)	West
WHITPDZZ	Whitmore Vale (Grayshott) SPS	South	West A	MAINTENANCE AOPT STH PUMP (SOUTH)	West

### 5.3.1 *GIS Validation*

From historic records, the research obtained a copy of the data presented in Figure 5-4, this came from the corporate asset information repository. It provided data on each of the rising mains located at the discharge points of the Bordon pumping stations. The key data contained within included the following.

- Rising main diameter (mm)
- Rising main length (m)

There were some data on pipe material; however, these were not consistently available within the records. The research sought to validate the piping information obtained, and thus, through access to the corporate geographic information system (GIS), this was completed. Figure 5-5 is the fully validated catchment overlay following a GIS inspection.

Figure 5-4 Bordon catchment before GIS validation

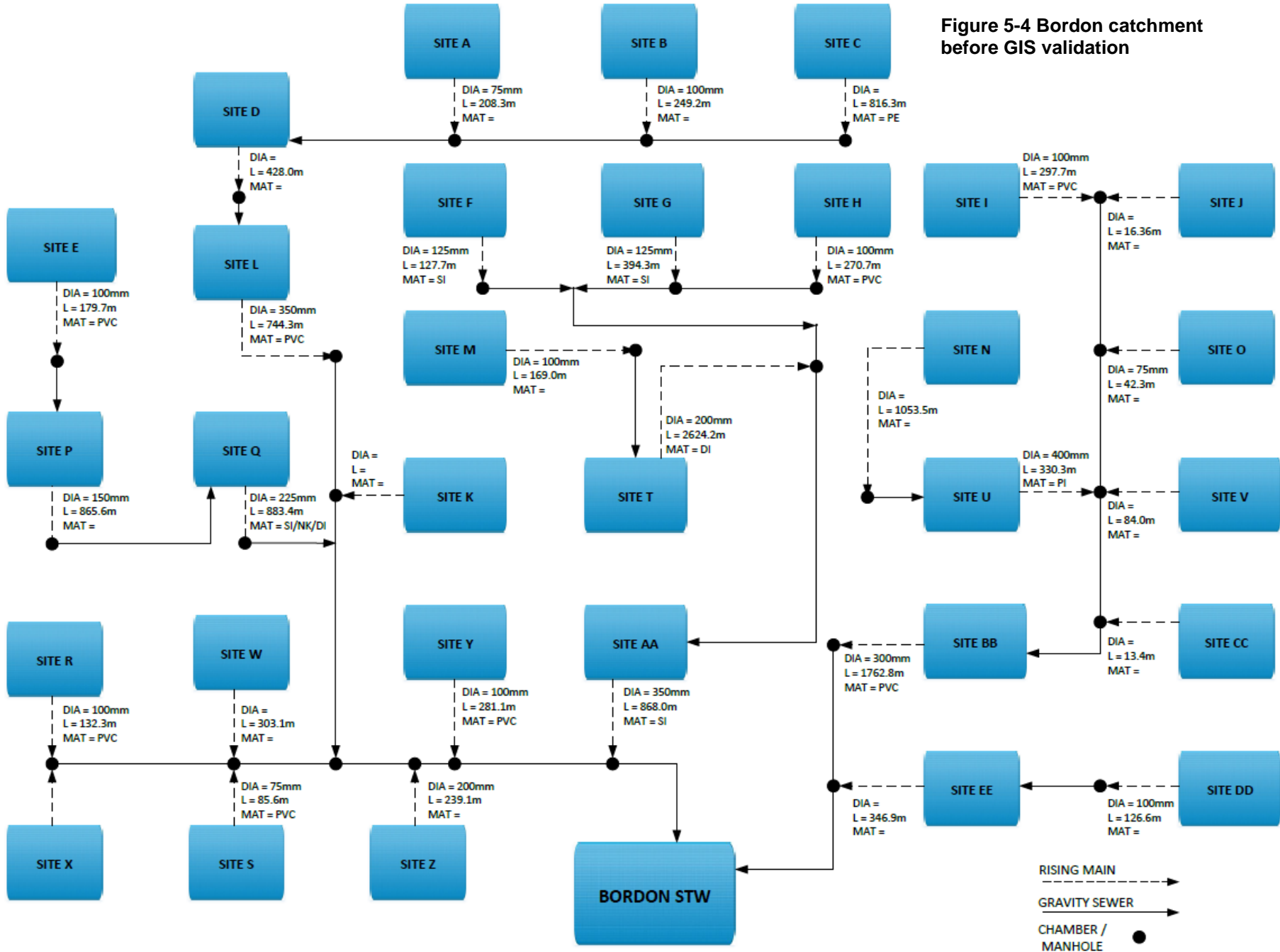

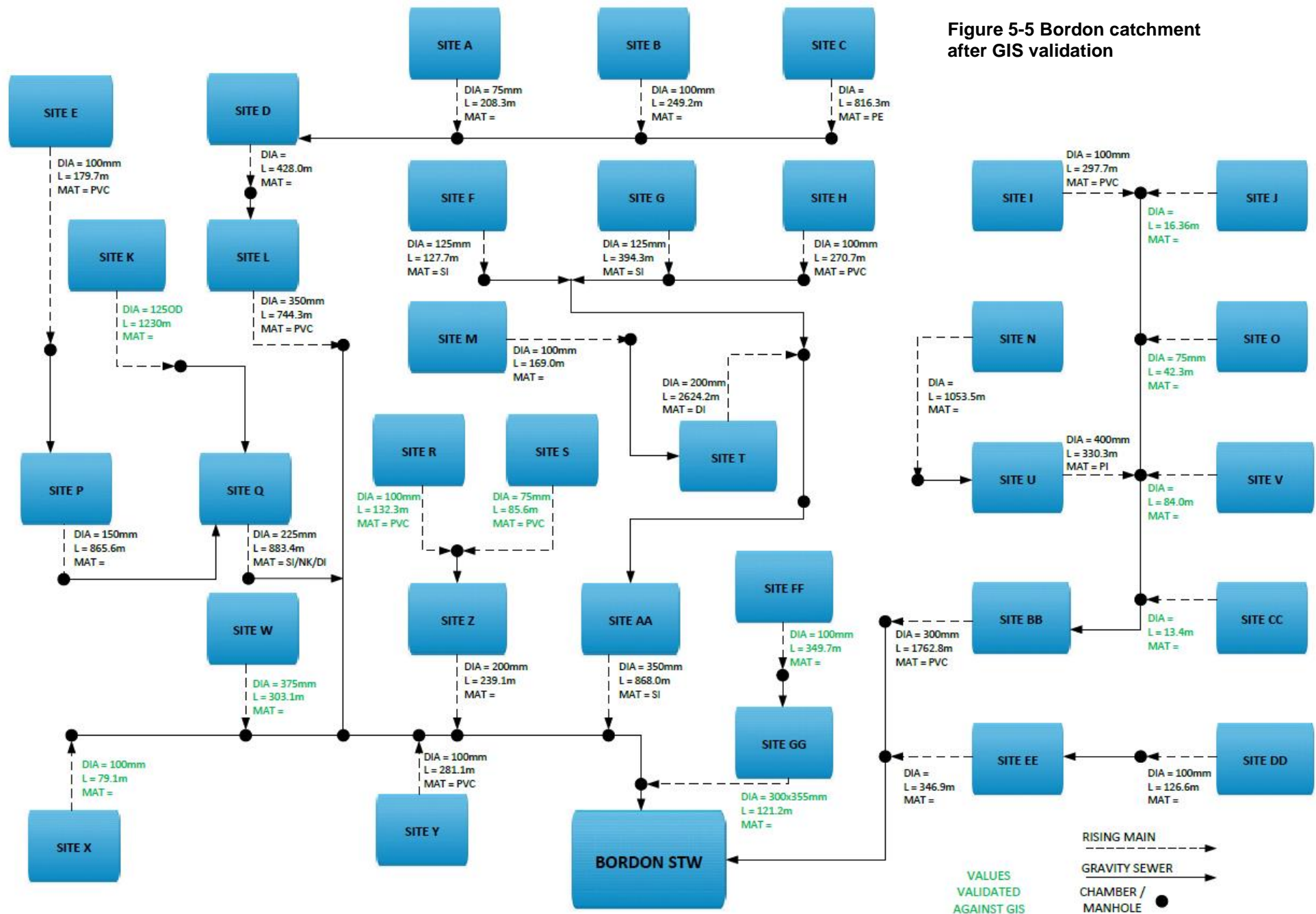

## **5.4 Model Validation**

Upon selection of the Bordon waste-water catchment, the existing hydraulic model was inspected. This hydraulic model, which was used for flood modelling, housing development impact assessments and other hydraulic metrics, but was not used for energy management, provided an extremely detailed overview arrangement of the network's pipes and interconnected nodes. However, there were discrepancies between the software and the real-life system in terms of the pumping station configuration data. In particular, the rising mains that connected pumps to downstream manholes were not physically modelled, and as such, no pipe data, including downstream head and friction losses, were configured. This meant by using the model results output file in its current form, any mechanical power calculation using head and flow would not be accurate enough for further onward electrical calculations and optimisation analysis due to the missing rising main configuration. In this scenario, the model links the pumping station to the receiving manhole with a virtual connection, which consists of no configuration and so all hydraulic effects are negated. Similarly, the pumps in the software model are not configured with any head / discharge data (assumed or manufacturers) and so output power results are not available as a standard offering. From discussion with modelling subject matter experts, the author concludes that this is quite often the case within water a company's hydraulic model, as they are not usually set up for power derivatives.

As a response to the lack of data, all 33 pumping stations in the catchment were physically surveyed by the author with data on pump configuration, start / stop levels, pump head / discharge curve data, existing control sequences and all associated hardware configuration being collected.

### *5.4.1 Conversion to metres above ordnance datum*

One constraint from the data available on site was that the start and stop levels used in the ultrasonic level instrument for the pumps were configured with a reference to the bottom of the well chamber, which is an industry standard practice throughout the UK water companies. This bottom reference had no relation to metres above ordnance datum (mAOD), the points of reference used in the hydraulic model, and so an additional requirement to convert all actual pumping station measurements into this format was needed. This was achieved by land survey employing a total station theodolite to gain a spot height for each of the well chambers top reference. From this top reference, each of the below ground points of interest could be measured and



converted into mAOD. An example of one of wet wells inspected on the survey is shown in Figure 5-6. For all other pump station parameters captured during the authors survey please refer to appendix 2.



**Figure 5-6 Example wet well from photo taken during surveys**

Figure 5-7 shows a typical example architecture of a UK wastewater pumping station, which the SPS well chambers from the 33 surveyed aligned with. It also highlights the marker on site from which the spot height was taken in mAOD as per Figure 5-6 above.

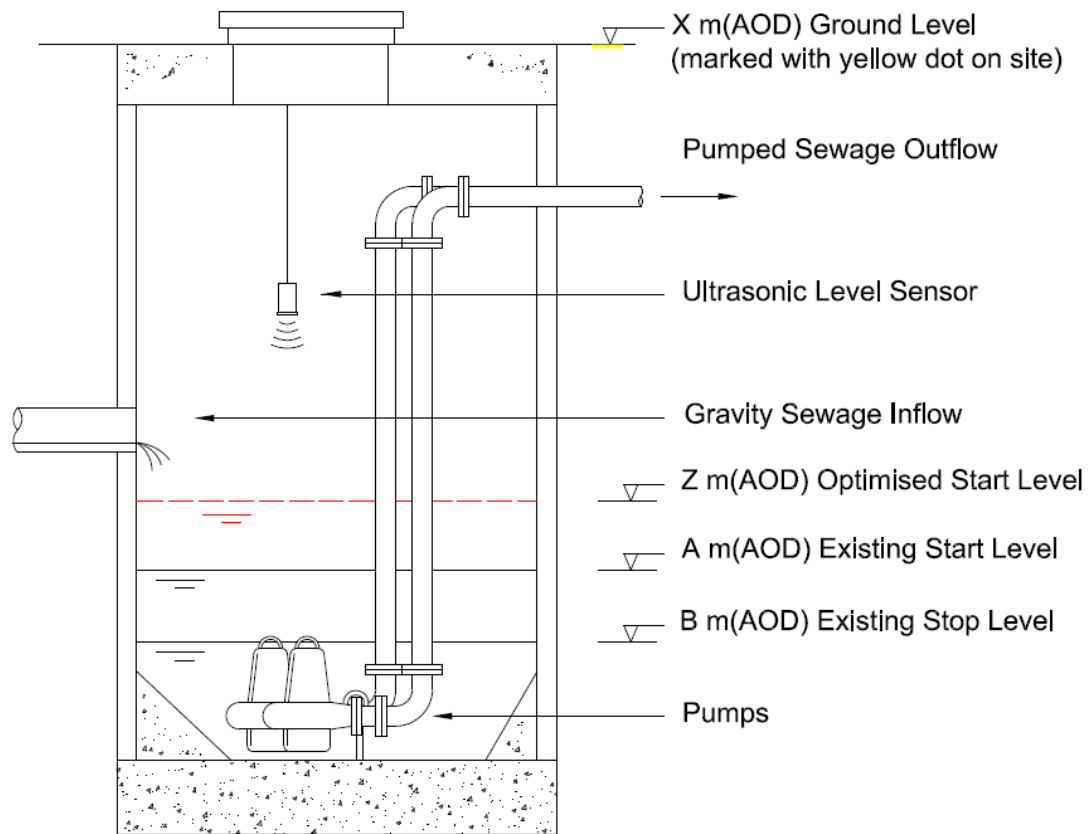

**Figure 5-7 Cross sectional view of typical UK SPS [132]**

From this, the data was converted into a format suitable for use in the model and was completed for all pumping stations.

Table 5-2 provides an example mAOD data for a three-pump station configured as a duty / standby / assist system. The catchment comprises mostly two pump stations configured as duty / standby. Where a station is duty / standby, only one pump will ever run at any one time and so for the purpose of power calculation, this is considered as a site with a single pump. For sites with assist configurations, the assist pump can run in parallel with the duty pump and so power calculations consider these stations as 2 or 3 pump sites respectively. From a review of the system architectures across the Bordon catchment it was determined that there are the equivalent 42 individual pumps spread over the 33 sites. The information on well chamber configuration taken

from the sites was a vital step in getting the model setup correctly as it had previously been built up on a lot of assumed data, which in some places was missing or incorrect.

**Table 5-2 Example wet-well chamber converted to mAOD**

<b>Parameter</b>	<b>Distance to cover (mm)</b>	<b>Metres above ordnance datum (mAOD)</b>
Cover level (spot height)		69.439
Bottom of well chamber	4,450	64.989
<b>Water Level</b>		
Reading from controller	530	65.539
Height from cover level at point of reading	3,900	65.539
<b>Ultrasonic / Control</b>		
Start level (duty pump)	1,000	66.009
Stop level (duty pump)	600	65.609
Start level (standby pump)	1,200	66.209
Stop level (standby pump)	602	65.611
Start level (assist pump)	1,500	66.509
Stop level (assist pump)	604	65.613

#### 5.4.2 Lidar overlay and Rising Main Construction

The next step within the hydraulic model before optimisation was to construct all rising mains using a Lidar layer overlay as these were not previously available within the model. The addition of these new rising mains, constructed by the author and taken from real world data, enabled a much more accurate system curve to be programmed, including pipe diameter, roughness and, therefore, enabling friction and downstream head losses to be accounted for during the model run. This was a large improvement on the existing model, which previously did not account for any topography / level changes at all. Figure 5-8 shows an example rising main after it had been remodelled within the design environment. The pumping station and wet well are shown to the left, with the first green circle depicting the existing well chamber and the red triangle of the pumping station. The purple line that runs across the plot from left to right is the Lidar overlay, which has had sealed negligible volume manholes configured at suitable points in the topography. This is done until the rising main meets with the original downstream manhole connection and the system continues, as previous, with the existing gravitational flows. The brown shaded area depicts the ground level as a result of interpolation between the newly configured manholes and is a best fit against the Lidar overlay.

The author constructed a new rising main using Lidar overlay within the hydraulic model for every pumping station. By using cross sectional view the research could interpolate a best fit between the pump station and the upstream connection at which gravitational flows begin again.

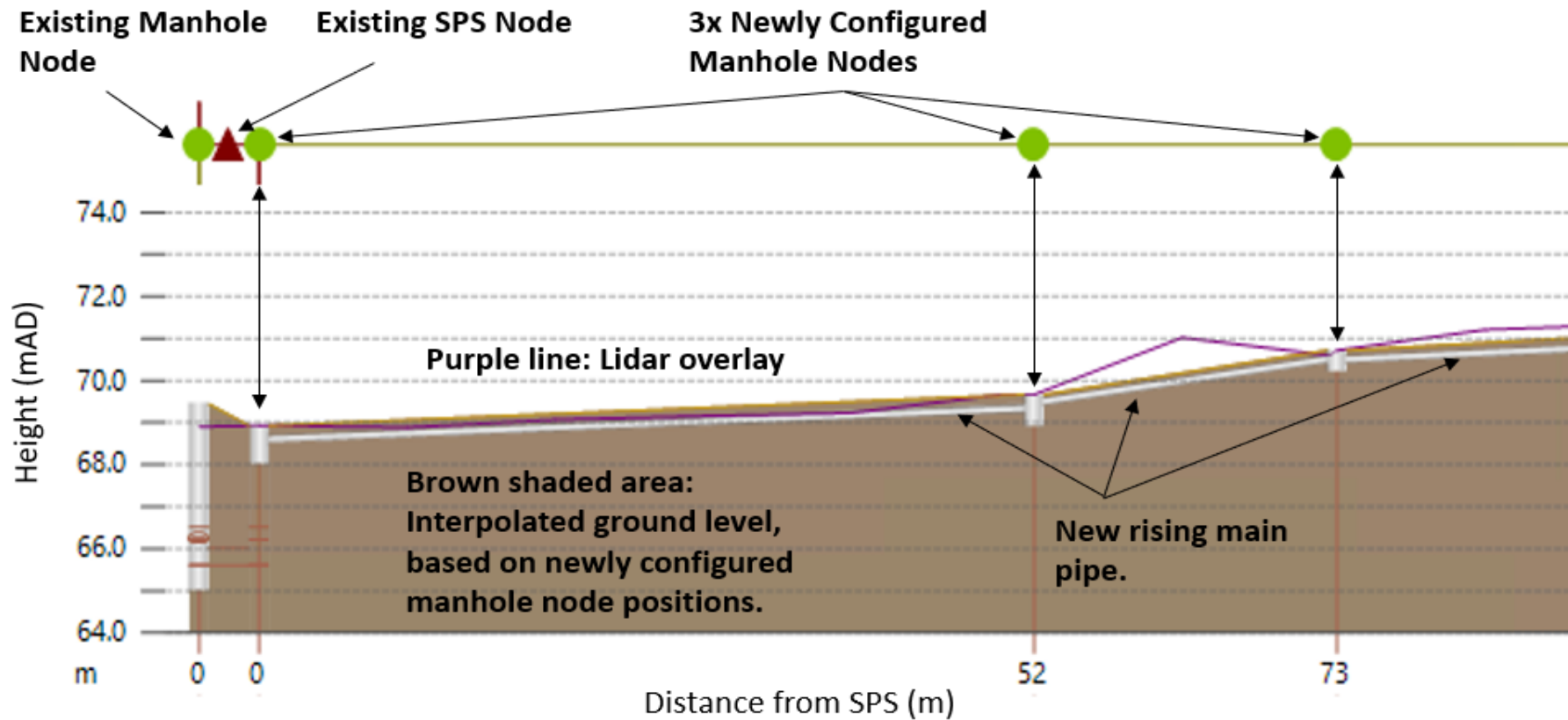

Figure 5-8 Cross section of a pump station and lidar overlay

#### 5.4.3 Modelling Pump Curves within the Hydraulic Model

Within the Innovyze Infoworks (ICM) modelling software environment for the Bordon catchment there were no pre-existing parametric data representing the real-world pump configurations. All pumps had been left with the default settings as per the software's initial installation and setup.

During the site surveys, the research obtained the real-world pump configurations from the data tags that were left on site. It is common practice to leave data tags on site so that operations and maintenance teams have a local account of the unit installed in the wet-well without having to lift the asset. An example taken from one of the sites is shown in Figure 5-9.

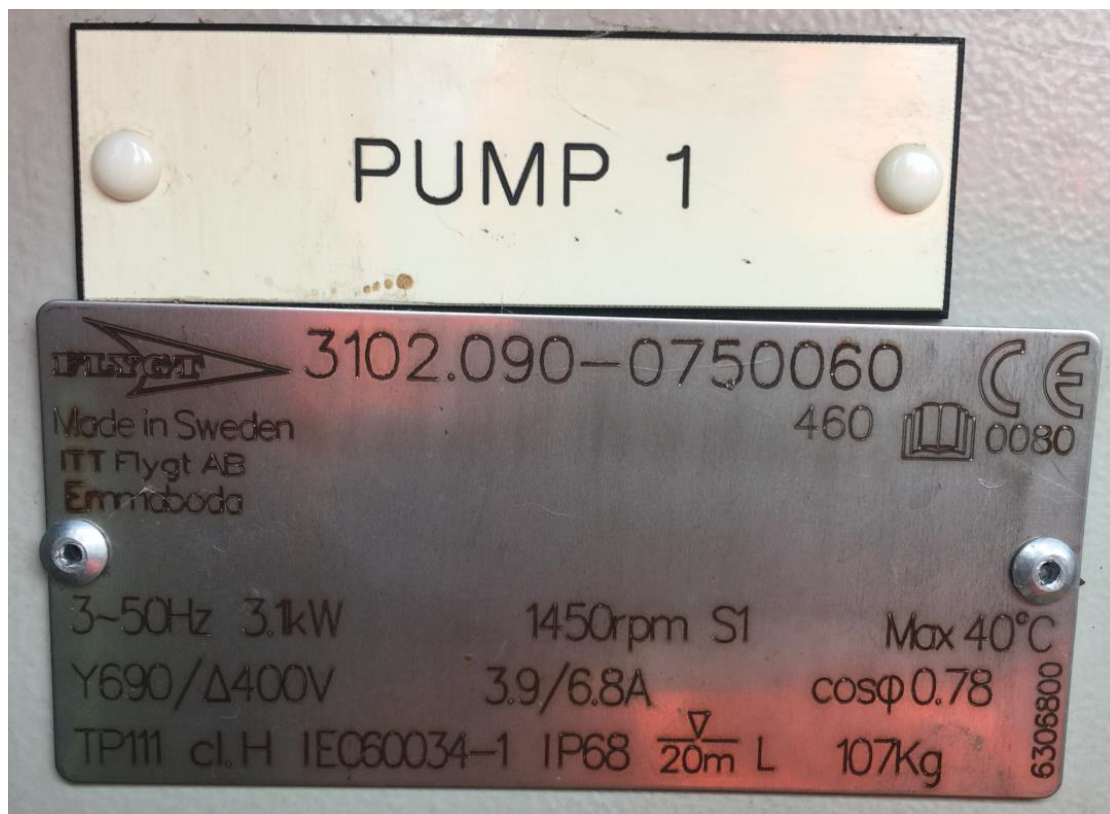

Figure 5-9 Example Site Drive Pump Nameplate

From correlation with the manufacturers archive of online datasheets the research was able to obtain the head / discharge curves for 24 of the sites within the catchment.

As discussed previously in section 5.4 the author concluded that it is quite common for a water company's hydraulic model to not be set up for power derivatives, as this is not the primary output the modelling teams require. With regards to this research, it was found that without the head / discharge information, the accurate calculation of

real-world pump power within the hydraulic model would not have been possible and thus, would have been built upon arbitrary configurations only. This is why the researcher ensured as much pump data could be captured locally from site during the surveys. All datasheets required by the research following the site surveys were then acquired from Xylem Inc [133] and are presented separately within Appendix 3.

NOTE: For the remaining 9 sites where the data plates were not available the local site operating manuals were inspected for the kW rating and the best fit curve (based on data plates extracted within the same catchment) was applied.

#### *5.4.4 Calculating Electrical Energy within the Hydraulic Model*

The requirement for the total electrical energy calculation to be generated as an output from the hydraulic model came from the fact that this was the primary variable in the objective function. I.e., reduce electrical energy. And this was needed as an output from the hydraulic model, via the API, into the modeFRONTIER optimiser.

The advantages of doing this in the model is that each model iteration will utilise the same baseline electrical energy calculations for every model run. It is understood by the author however, that the calculated energy within the model will not necessarily equal the site assets energy output. Things such as asset degradation will mean the site units are slightly more inefficient and drawing more current. It was concluded that by using the calculated model power, the results would stand up in terms of demonstrable reduction / increase in power, which would enable the optimiser to fine tune the operating parameters.

Within the modelling environment a rotodynamic pump is the object required when programming head / discharge curves within the setup. They are used to represent a link of zero length, forming a head-discharge relationship between two nodes (manholes). The boundary condition between the link and a node is that of equal water levels. The pump switch-on level determines when the control first comes into operation; the pump will continue running until the upstream water level drops below the lower switch-off level.

During a simulation the pump status is updated every major time-step. If, at a minor timestep, the pump status is on but the upstream level drops below the switch-off level, an intermediate switch-on state is entered; this conserves volume.

#### 5.4.4.1 Pump Characteristics

The flow characteristics in the positive direction are determined from the pump head-discharge curve. The governing model equation assumes a fixed discharge monotonically so the simulation engine may determine a unique discharge for a given head. The equation is as follows:

$$Q = f(h) \quad (5.5)$$

Where:

- $Q$  = the discharge in m<sup>3</sup>/s
- $f(h)$  is a user-defined function given by a series of values relating head to discharge.
- $h$  = the head across pump in m. The head is equal to the difference between downstream and upstream water levels.

The pump connects two nodes, representing the water level upstream and downstream of the rotodynamic pump. The discharge will be identical at both nodes on convergence of the model iteration.

The relationship between discharge and head is represented as a table, defined in a head discharge table object. The first discharge value, corresponding to the closed valve head, must be zero. Intermediate values are interpolated linearly from the table. Values outside of the table range are linearly extrapolated from the last two table entries. During some initial runs, the research found that hydraulic power was the variable being calculated within a model run and so some further tuning of the hydraulic power calculation was required to convert this to electrical energy as an output.

This was then confirmed in discussions with Innovyze and concluded that the instantaneous power output being extracted from the model run was the hydraulic power. The hydraulic power, which is also known as absorbed power, represents the energy imparted on the fluid being pumped to increase its velocity and pressure. The various powers may be calculated using formulae below [134].

$$P_h = \frac{Q\rho gh}{3.6 \cdot 10^6} \quad (5.6)$$

Where:

- $P_h$  = Hydraulic power of the pump (kW)
- $Q$  = Volumetric flow of the fluid through the pump (m<sup>3</sup>/h)
- $\rho$  = Density of the fluid being pumped (kg/m<sup>3</sup>)
- $g$  = Gravity (9.81 m/s<sup>2</sup>)
- $h$  = Head produced by the pump (m)

The shaft power is the power supplied by the motor to the pump shaft. Shaft power is the sum of the hydraulic power (discussed above) and power loss due to inefficiencies in power transmission from the shaft to the fluid. Shaft power is typically calculated as the hydraulic power of the pump divided by the pump efficiency as follows.

$$P_s = \frac{P_h}{\eta_p} \quad (5.7)$$

Where:

- $P_s$  = Shaft power of the pump (kW)
- $\eta_p$  = Pump efficiency (%)

The motor power is the power consumed by the pump motor to turn the pump shaft. The motor power is the sum of the shaft power and power loss due to inefficiencies in converting electric energy into kinetic energy. Motor power may be calculated as the shaft power divided by the motor efficiency.

$$P_m = \frac{P_s}{\eta_m} \quad (5.8)$$

Where:

- $P_m$  = Electrical power required by the motor (kW)
- $\eta_m$  = Motor efficiency (%)



The table below provides some typical efficiency values which may be used for power requirement estimation for a selection of pump types. These values are for correctly sized pumps, if a pump is oversized or poorly designed its efficiency may be much lower than the values quoted below, this is particularly common in small pumps.

**Table 5-3 Typical Pump Efficiency Values [134]**

Pump Type / Component	Typical Efficiency
Centrifugal Pump	60-85%
Sliding Vane Pump	60-90%
Gearbox	70-98%
Belt Drive	70-96%
Variable Speed Drive at Full Speed	80-98%
Variable Speed Drive at 75% Full Speed	70-96%
Variable Speed Drive at 50% Full Speed	44-91%
Variable Speed Drive at 25% Full Speed	9-61%

With all pump asset data now uploaded into ICM model design space, the model was able to be executed and the calculations for pump mechanical power completed. As discussed, the model only dealt with mechanical power and there was a requirement to convert this into electrical power and then integrate for energy, as this was the optimisations objective variable. In order to calculate this efficiently, the matrices for the resulting flow ( $Q$ ), downstream head ( $h_d$ ) and upstream head ( $h_u$ ) were extracted from the model into a result .csv file. From here, and considering the power equations discussed in equations 14-16, the .csv was forwarded through a series of calculations. This was done for each pump as follows:

Pump mechanical power:

$$P_m = \frac{(Q \cdot 1000) \rho g (h_d - h_s)}{3.6e + 6} \quad (5.9)$$

Where:

- $h_d$  = Downstream head \*\*
- $h_s$  = Upstream head \*\*
- $Q$  = Flow \*\*

Note: (\*\*) These are the three matrices exported from the model and are sampled every five-seconds during a one-month period.

Then, for pump instantaneous electrical power:

$$P_{iE} = (P_m / \eta_m / \eta_p) + c \quad (5.10)$$

Where:

- $\eta_m$  = Motor efficiency = 0.8
- $\eta_p$  = Pump efficiency = 0.75
- $c$  = Correction factor = 3.5

The correction factor of +3.5 per pump was included to cover off the non-pump related loads, such as pumping station building services, including lighting, heating and ancillary control system loads. This value of 3.5 was an average constant that allowed the model output to fit as closely with the DNO energy metered output, and without having to apply individual corrections per pump across the catchment.

Thus, the electrical energy consumption, per pump over period  $t_0, t_k$  is calculated as presented in Wei, Zhang [135] and shown below.

$$P_{tot} = \int_{t_0}^{t_k} \sum_{i=1}^n u_i(t) P_{iE}(t) dt \quad (5.11)$$

Where:

- $P_{iE}(t)$  is the energy consumption of the  $i^{th}$  pump at time  $t$
- $u_i(t) = \begin{cases} 0, & \text{off} \\ 1, & \text{on} \end{cases}$  is pump running / stopped at time  $t$

The declaration of  $u_i(t)$  is of significant importance based upon the previous discussion on duty / standby and duty / assist arrangements in section 5.4.1 as this parameter will differ across each pump station based on the system configuration.

For duty / standby

$$m_{k_i}^{st1} (u_1(t) = 1 \rightarrow u_2(t) = 0) \quad (5.12)$$

$$u_1(t) = 0 \rightarrow u_2(t) = 1$$

- If  $u_1(t) = 1$  then  $u_2(t) = 0$
- If  $u_2(t) = 1$  then  $u_1(t) = 0$

Where:

- $m$  = individual pump unit being inspected

#### **5.4.4.2 Baseline test**

The calculations were applied to a 31day period of dry weather flow in order to establish a baseline result. This calculated that the modelled electrical pump power consumption for the wastewater catchment was 21,127kWh. This was then cross-referenced against the water company's N-Power energy bill as a validation exercise, which showed that for the same month in July 2017, the energy bill had shown electrical energy consumption of 29,434kWh. This delta was largely attributed to the other services on these sites; lighting, heating (some heaters are left permanently on irrespective of seasonal conditions), small power etc. When accounting for these losses, the conclusion was that the model was now sufficiently robust in calculating catchment electrical energy and could therefore, be taken forward into an optimisation.

Before linking the model into any automated optimisation sequence a basic test was performed to explore the outcome by slightly deviating the initial conditions on the profile control of the catchment. This was done by increasing the pump start levels (the manipulated variables the optimiser would change) across all pumps by 50mm, with the assumption that lower energy consumption will result through the throttling of flows, thus utilising natural capacitance within the network. It would also test if any of the manhole nodes within the model would flood as a result. Following this test, none of the network nodes flooded and an overall reduction in electrical power consumption of 325kWh was obtained over the 31day period. When applied against an average tariff cost of £0.28 / kWh across seven service providers [136], a cost saving of £91 / month was yielded.

At this point the research concluded that the model was now fit for purpose, as it had been updated to align more closely with the real-world configuration and had proven that subtle variations in the pump start levels would have an impact on the overall energy output. The model was now ready to have a more complex optimisation sequence deployed over it. This is proposed in Chapter 6.

## **5.5 Summary**

Chapter 5 focused on the Bordon waste-water catchment and examined the existing hydraulic model used for various purposes such as flood modelling and housing development impact assessments. However, the model lacked accurate data for energy management. Specifically, the model did not include the configuration of rising mains and pump characteristics, which were crucial for accurate power calculations and optimisation analysis.

To address this issue, the author physically surveyed all 33 pumping stations in the catchment and collected data on pump configurations, start/stop levels, pump head/discharge curves, and control sequences. The collected data were then converted into mAOD, a reference used in the hydraulic model. This conversion was necessary because the ultrasonic level instrument used for the pumps utilised an isolated reference point.

The next step involved constructing rising mains using Lidar overlay, which enabled the provision of more accurate information about pipe diameter, roughness, and downstream head losses. This improvement allowed for a more precise system curve plot within the model.

The research obtained real-world pump configurations from data tags left on site and manufacturer datasheets. This information was crucial for accurately modelling the pump curves within the hydraulic model. For sites where data plates were unavailable, operating manuals were consulted to determine the kW rating and approximate pump curve.

To calculate electrical energy within the hydraulic model, the research needed the total electrical energy as an output from the model. Rotodynamic pump objects were used to program the head/discharge curves. Hydraulic power, shaft power, and motor power were calculated based on these curves and efficiencies.

The model was then executed, and calculations for pump mechanical power were completed. To convert mechanical power to electrical power, correction factors were applied to account for non-pump related loads. Finally, the electrical energy consumption per pump over a given period was calculated.

Overall, Chapter 5 addresses the lack of data in the existing hydraulic model, collected accurate pump information, and enabled the calculation of electrical energy for optimisation purposes.

# Chapter 6

## Optimisation of a Wastewater Catchment

This chapter details the optimisation of the Bordon wastewater catchment hydraulic model. It starts by reviewing the design space and, as such, how this further led to the selection of the respective techniques for searching towards an acceptable solution. Discussions on the algorithms deployed and the results they yielded are presented.

### 6.1 *The Design Space*

By studying a similar research programme, discussed in [137], the current research posits that as the dimension of the decision space grows, the complexity of the problem increases dramatically. Further analysis of research conducted by [138] concludes that the high-dimensional problem is much harder to determine when the number of decision variables increases.

This is of particular significance on models of high-dimensional discrete data, such as sewer networks, because there are many more possible combinations of variables that can be observed in a data set. The challenging aspect of this study was that there were 42 individual pump start / stop variables. Thus, the author concluded that this meant a multi-variable high-dimensional problem for solutioning was proposed.

The author of this research studied a variety of optimisation strategies across several fields from the literature [139-142]. It is in the opinion of the author that they all converge with a similar approach. That is, for multi-dimensional design spaces, where this design space is not fully known, then using robust global algorithms (evolutionary, heuristic) on their own may perhaps get towards the correct peak for exploration; however, an optimal solution is unlikely. Furthermore, by only using more accurate local algorithms (hybrid, gradient based) there is the risk that the optimisation will focus narrowly on the wrong peak and therefore, not achieve the optimal solution. Based on the fact the research was looking at a design space comprising 42 variables, similar to the architectures presented in [139-142] the author concluded thus, a requirement for a mixture of both global and local optimisation techniques would be needed. Although the literature studied by the author was of a similar architecture, and that is what helped conclude in the strategy, the other fields of research had not performed this on wastewater pumping systems and by doing so proposed a novel application.

The next characteristic requiring exploration was on whether the optimisation within the objective function would be constrained or unconstrained. Constrained optimisation is the process of optimising an objective function with respect to some variables in the presence of constraints on those variables, especially nonlinear optimisation problems and where objective functions are minimised under given constraints (Takahama and Sakai [143]).

By considering the wastewater optimisation problem, the author infers that the variables are therefore, pump start / stop levels and that these variables are constrained by the height of the wet-well in which the pumping stations concrete chamber comprises, then this would be a constrained optimisation where the objective function is minimised. (i.e., minimise electrical energy).

## 6.2 Problem formulation

The wastewater catchment optimisation problem can be formulated as follows:

$$\begin{aligned}
 &\text{minimise} && f(\bar{u}, \bar{x}) \\
 &\text{subject to} && g(\bar{u}, \bar{x}) = 0 \\
 &&& h(\bar{u}, \bar{x}) \leq 0
 \end{aligned} \tag{6.1}$$

Where:

- $f$  is the objective function
- $g$  are the equality constraints
- $h$  are the inequality constraints
- $\bar{u}$  is the control vector
- $\bar{x}$  is the state of the hydraulic network

The vector  $\bar{u}$  contains the independent variables for optimisation, in this case the wet well level in which to start a pump. From this, the research then defines the objective function as the total electrical energy across the wastewater network, as per equation (19).

$$f(\bar{u}, \bar{x}) = \int_{t_0}^{t_k} \sum_{i=1}^n u_i(t) P_{iE}(t) dt \quad (6.2)$$

Where  $i$  is 1 – 42 of the pumps within the catchment, all summated between period  $t_0$  and  $t_{44,640}$  in one-minute samples across the 31-day test period.

The equality constraints  $g(\bar{u}, \bar{x})$  are determined by the flow into and out of the catchment, i.e., all the ways in which wastewater enters the catchment and is then pumped into the receiving treatment works, and thus the difference must be zero. Any positive deviation would equate to more flow entering the catchment, versus what is treated at the works, and as such is likely lost volume in the form of spills and pollution.

$$\sum_{i=1}^n Q_{SWi} + \sum_{i=1}^n Q_{PWi} - Q_{RT} = 0 \quad (6.3)$$

Where:

- $Q_{SWi}$  = input flow to the catchment from surface water runoff at the  $i^{th}$  node
- $Q_{PWi}$  = input flow to the catchment from any property at the  $i^{th}$  node
- $Q_{RT}$  = input flow to the receiving treatment works

The inequality constraints  $h(\bar{u}, \bar{x})$  model the physical limits of the wastewater catchment and are represented using the equation below:

$$h_{k_i}^{min} \leq h_{k_i} \leq h_{k_i}^{max} \quad \text{for } i = 1 \text{ to } n \text{ wet wells} \quad (6.4)$$

For all wet wells  $k_i$ , the optimiser must stay bounded within the permitted height as surveyed by the research.



Thus, the optimisation problem can be summarised as finding the control variable  $\bar{u}$ , (i.e., the start set point level per pump) that minimises the total catchments electrical energy demand whilst ensuring the equality and inequality constraints are respected.

### **6.3 Choice of strategy**

Research conducted by [144], which looked to minimise the electrical generation costs within an optimal power flow problem (OPF), found issues when looking to optimise a mixed-integer, non-linear problems including discrete and continuous variables.

The current research finds no evidence within the literature of a wastewater hydraulic model being classified in terms of a mathematical model for the purpose of electrical power optimisation and as such there is no literature on the application. However, when considering the optimisation challenge as discussed by [144] and [145] on OPF and optimal reactive power dispatch (ORPD), there are parallels that can be drawn and thus learnings transferred into the current challenge.

For example, reviews of the ORPD problem, which as discussed determined a mixed-integer non-linear programming problem combining discrete control variables (transformer tap settings) and continuous variables (generator voltages) can be used to inspect the current model within this thesis. By considering the parallels as follows:

- There are discrete variables in the form of the pump start levels, which are constrained as per the physical well in which they apply.
- There are continuous variables in the form of the flows within the network and the electrical power consumption of the catchment (including all individual pump assets).

Thus, the research concludes that the current optimisation challenge presented falls into the same classification, and is a mixed-integer, non-linear problem including discrete and continuous variables. Over the last few decades, and as the literature has expanded in the area of optimisation, research has continued to use classical techniques for problem solving. This includes methods such as

- Successive quadratic programming (SQP) as presented by [146].
- Non-linear programming used in collection methods for used product at the end of its life and presented by [147].
- Mixed integer programming reviewed in research presented by [148].

- Gradient-based methods discussed by [149].
- Newton-based method, which [150] propose as a better alternate to gradient-based as it comprises better convergence characteristics.

Additional reviews of [145] find that where classical optimisation techniques (as per the aforementioned sample above) have excellent convergence properties, they often converge to a local minimum. Further, they tend to fail in finding the global optimum based on the initial stochastic guess and struggle in handling discrete variables. The author has used Matlab to generate some random surface plots in order to visualise the design space challenge. Figure 6-1 shows an example design space with a single peak for exploration. In this case a local search strategy would be sufficient in locating the optimal point on the plot. Conversely, Figure 6-2, which shows a much more complex design space (and is a good representation of the wastewater challenge) may struggle with certain optimisation algorithms as their arbitrarily selected starting point may not land on the peak containing the overall optimal solution.

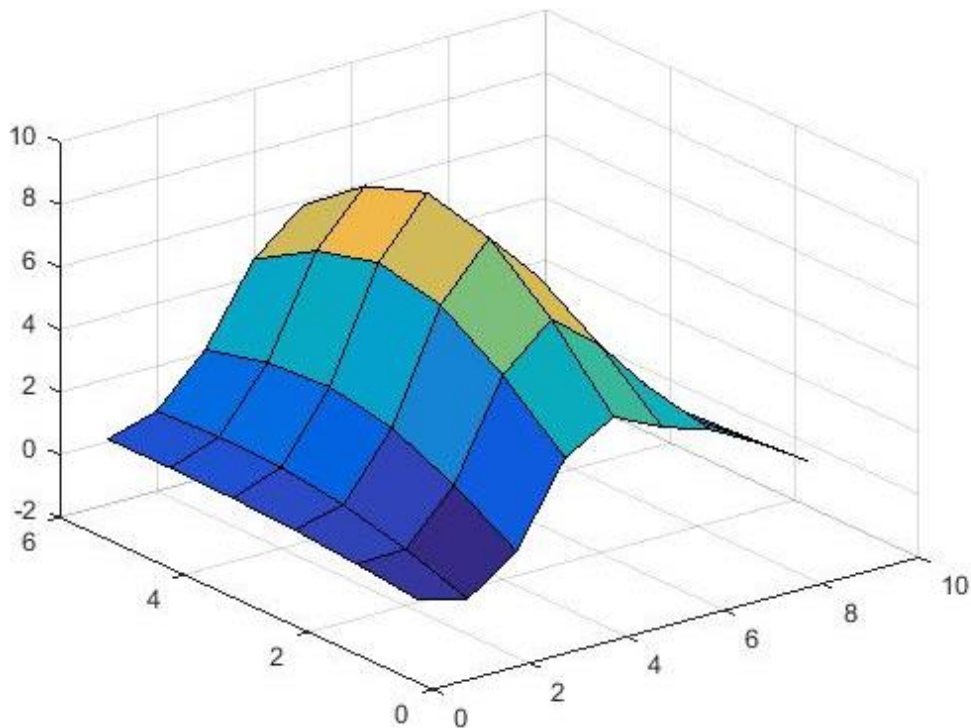

**Figure 6-1 Example of single peak design space**

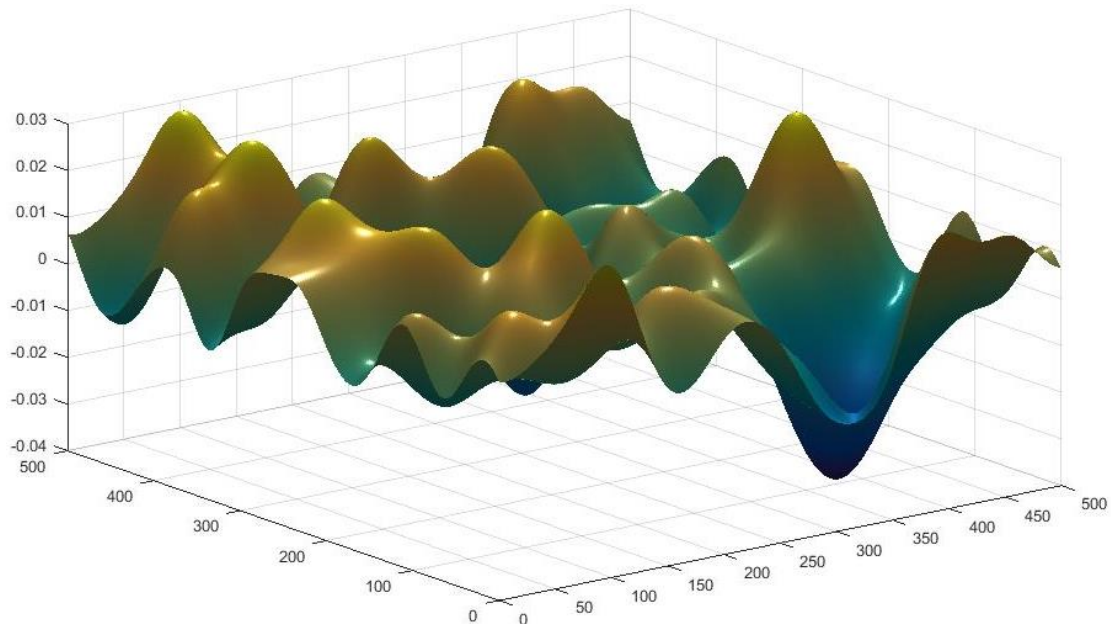

**Figure 6-2 Example of multi-peak design space**

[151] presented a sound rationale on the use of multi-strategy metaheuristics, which were explained as a family of optimization methods that rely on the iterative improvement of candidate solutions to a given problem. They require very little information about the problem and are relatively simple to set up. Further, they do not require any prior gradient information of the problem and are not constrained into converging upon local optima.

In order to combat this, there was a requirement to employ an optimiser that was dynamic in starting globally before switching to a local function and fine tune the peak. For these reasons, the author concluded that a mixture of multi-strategy algorithms would be used in order to solve the proposed design space challenge.

#### **6.4 Computational Setup**

As previously discussed, the target companies hydraulic modelling package uses Innovyze Infoworks™. This product enables third party integration through API's and Ruby scripts when the ICM Exchange service is enabled. As a result, the research looked at opportunities to exploit scripting in order to run the chosen optimisation strategy.

The first approach initially investigated the use of a CS-script tool that would export the results tables directly from the Innovyze Infoworks™ environment into CSV format workbooks. From here the data could then be inspected, with the application of

mathematical tooling to optimise the pump start parameters before returning these back into the model and rerunning.

Note, the computational resource the research obtained to deploy the modelling and analysis tools comprised the following specification.

#### Hardware

- Dell Poweredge R720
- Intel Xeon Processor E5-2600 v2
- 2x Processor Sockets
- 32GB Memory random access memory (RAM) – 1866MT/s

#### Virtual Machine

- Hosted on VMWare Hypervisor v6.0.
- Windows Server 2012R2.
- Microsoft Excel 64bit.
- 16 virtual-central-processing-units (V-CPU's).
- Full provision of 32GB RAM – 1866MT/s.

Issues were highlighted in the first round of data exports as, even with a dedicated server offering 16-V-CPU's, and the specification as shown above, the Excel frontend environment was unable to process the very large data matrices being generated. There were regular failings of the Excel executable which led to an overall inability to inspect the data let alone run calculations on the matrices. When considering the five-second sample over 31 days this resulted in matrices in the order of [44x535682] per model run, with the calculations in (14-19) needing to be applied on a per cell basis.

Table 6-1 shows a sample cut of the master table (contained separately in appendix 4). As can be seen, the table shows the first three 5second samples and the last three 5second samples. It shows this for the first 4 sites, listed in alphabetical order.

These performance issues presented a major challenge to the research as it was clear from the behaviour of the excel application that progress on matrix calculations of this size would be unachievable. Within one of the authors quarterly meetings with the industrial sponsor (Thames Water Utilities Ltd), discussions led to an introduction with a UK software vendor, who at the time were licensed to distribute the Esteco modeFRONTIER™ platform. At the time, the author performed some market analysis to determine if there were any other vendors of this type of software, which there were

some close competitors. The primary reason for sticking with the modeFRONTIER product was due to the fact they had already developed the API for integration with the Infoworks™ environment, which was essential for deploying the optimisation.

**Table 6-1 Sample Extract from Model CSV Export**

<b>Time</b>	<b>Seconds</b>	<b>APOLLO DRIVE (APOLP1ZZ).1</b>	<b>ARFORD (ARFOP1ZZ).1</b>	<b>ASHGROVE (ASHGP1ZZ).1</b>	<b>BRAMSHOTT COURT (BRAMP8ZZ).1</b>
01/07/2017 00:00	0	5.13162E-05	0.002407	6.2E-07	9.68E-07
01/07/2017 00:00	5	0	0	0	0
01/07/2017 00:00	10	0	0	0	0
01/07/2017 00:00	15	0	0	0	0
31/07/2017 23:59	2678390	0	0.009639	0	0
31/07/2017 23:59	2678395	0	0.0096	0	0
01/08/2017 00:00	2678400	0	0.009561	0	0

The initial driver on the recommendation to use the modeFRONTIER™ platform was that the Infoworks™ supplier, Innovyze, had previous experience with their application programming interface (API). This API links the Infoworks™ and modeFRONTIER™ environments through the ICM Exchange service, which in turn enables some direct integration with optimisation toolsets, further removing the need for exporting data sets to other application executables (Excel) for processing.

### **6.5 Optimisation Environment Workflow**

Within the modeFRONTIER™ optimisation environment, the workflow was assembled as per Figure 6-3. The following parameters were configured:

- All groups switch on level - this was the manipulated variable within the experiment, it was a vector of 42 pump start levels. The boundary in which these operated was based upon the top of the specific well chamber and no lower than 75mm above the baseline stop level (the stop levels were all fixed constant).
- Duration – fixed constant
- Gauge Multiplier – fixed constant
- Timestep – fixed constant
- Results Multiplier – fixed constant

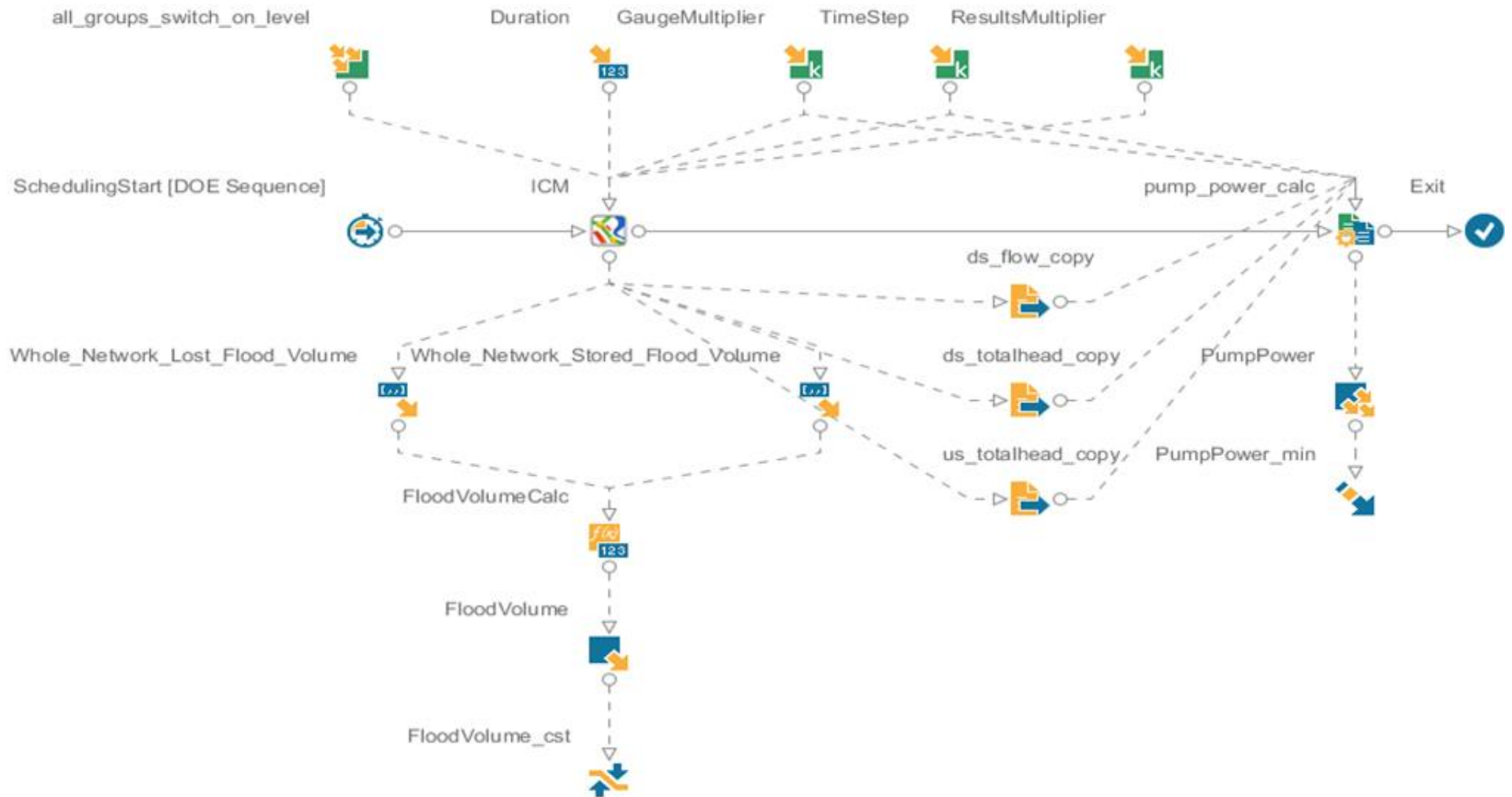

Figure 6-3 Optimisation workflow as assembled within the modeFRONTIER™ graphical user interface

The fixed constants were input to ensure that each model ran for a 31-day period at 5 second samples. The ICM node, directly right to the scheduling start node, is used as the API configuration interface for connecting through to the hydraulic model, importing the results, and exporting the new manipulated variables for trial. There is a branch that summates the whole network lost flood volume and whole network stored flood volume and constrains this to no greater than zero. I.e., all pollutions contained. The other branch takes the 3x [42x535682] results matrices for downstream head, upstream head and outlet flow and applies the power calculation shown previously for  $f(\bar{u}, \bar{x})$  in equation (22). From here it then stipulates the optimisation objective, which is to reduce this output pump power without breaching the flood constraint.

Appendix 5 contains a detailed breakdown of the configuration export of the modeFRONTIER environment, including the scripts used to assimilate the power equations.

## **6.6 Design of Experiments**

For verification purposes, the model was initially triggered to run via the workflow in a default mode to ensure functionality and to confirm that the original 21,485kWh output was still being output as a result. Each model run took approx. two-hours to complete, this was significantly high due to the need to have 5second samples over a one-month period. The decision to sample at such a high frequency was based on the evidence collected from the physical asset base, including SCADA runtimes and site observations, which saw some of the pumps only running for very short periods of time. In some cases, the pump would clear the wastewater from the well within 30seconds. This, therefore, required high frequency sampling in order to capture all pump downs within the model. This was tested by running some lower frequency sampling models and inspecting the data sets. It was evident that some pump operations were being missed with the lower frequency sampling and the model was interpolating the change in flow between nodes in an area that was not accessible to the author in the form of a data table. Thus, the matrix calculations for power output would not have been possible at this lower frequency.

Once this was completed and verified the optimisation sequencing could be initiated. This started with a design of experiments (DOE) to establish a baseline set of test data parameters for the chosen optimisation strategies to work from. Based on research presented by Tůmová, Kupka [152] the amount of DOE's chosen to be run is calculated as follows;

$$f(x) = V_x \cdot O_x \cdot 2 \quad (6.5)$$

Where:

- $f(x)$  = the number of DOE's need to be run initially.
- $V_x$  = the number of manipulated variables within the design.
- $O_x$  = the number of objectives the design is looking to solve.

This meant that with 42 manipulated variables (pump start levels) and one objective (reduce power) a DOE of 84 runs was required.

In order to achieve the most uniform distribution of variable configurations within the design space, across the 84 DOE model runs, a selection of strategies was inspected for suitability. Uniformity was crucially important to explore the full design space and minimise any prejudice towards a certain area when there could be more beneficial areas of design. As part of the decision making in selecting a suitable strategy, the time each model run took (2hrs) meant that a balance between quality over quantity was required. Where quantity will eventually fill the design space uniformly, it may lead to extremely inefficient usage of time and resource therefore, a balance of the two was required. Four strategies were explored:

- Pseudo Random
- Sobol
- Reduced Factorial
- Uniform Latin Hypercube (ULH)

#### 6.6.1 *Pseudo Random*

Pseudo random numbers, which are not technically arbitrary in their selection, are recursively computer-generated numbers. [153] continue in explaining that they are deterministic numbers generated by a computer hence why they are also sometimes referenced as deterministic pseudo-random numbers.

The pseudo random strategy was used to generate a distribution of DOEs within the design space. The results were plotted and are shown in Figure 6-4 as a two-dimensional allocation within the design space. A visual inspection of the results



concluded that there are a few areas of clustering in some parts (red rings) and large areas of unexplored design space (green filled rings). As a result of this inspection, pseudo random DOE selection was rejected as an option due to a lack of uniformity.

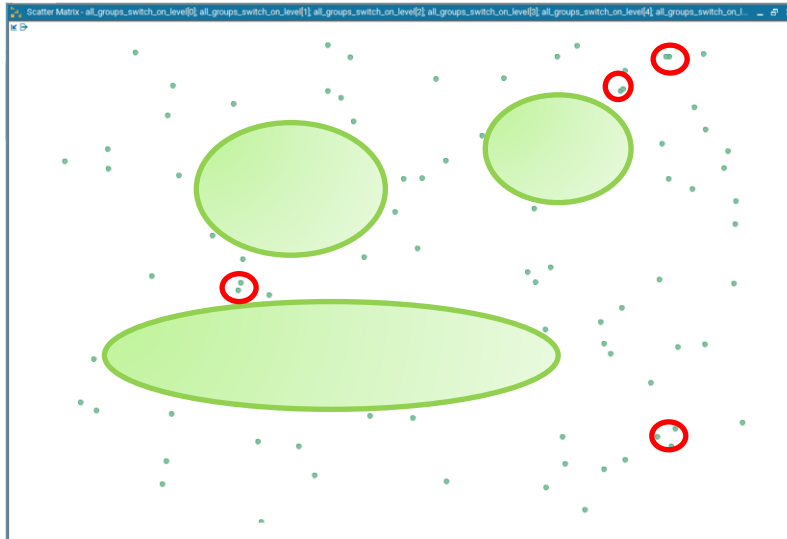

**Figure 6-4 Random scatter matrix, clear lack of uniform distribution within the design space.**

Other options considered were the full and reduced factorial methods. Reviews of [154] find that full factorial designed experiments consist of all possible combinations across all levels and for all factors. The total number of designs for studying  $k$  factors across two levels is  $2^k$ , for three levels  $3^k$ . This is backed up by [155] who also add that these methods employ a grid approach and provide excellent uniformity.

As the exponent  $K$  increases due to the rise in the number of design factors within the term  $2^k$  it is clear, that as the number of factors increase, the number of design iterations will also increase exponentially. With more iterations required, then inevitably more budget and time would be required. However, the research finds that from studies in Rahman [156] the options exist where; if it can be reasonably assumed that some higher order interactions (third order and above) are less important, then key information on the main effects of two-order interactions can be obtained by running a reduction of the full factorial experiment. This is where reduced factorial comes into play.

Reduced factorial designs are generally represented as  $2^{(k-p)}$ , for a two-level design. Again,  $k$  represents the number of factors and  $\frac{1}{2}p$  represents the fraction of the full factorial of  $2^k$ .

For example,  $2^{(8-2)}$  is a quarter fraction of a 256 full factorial design. This means that it may be able to study the eight factors at two levels in just 64 runs rather than 256 runs.

In the case of the current research the number of designs required for full factorial would be  $2^{42}$  and  $3^{42}$  for two-level and three-level designs respectively. This would put an unmanageable strain on the host application and hardware, it would also have taken far too long to complete within the allocated time.

#### 6.6.2 *Sobol*

Sobol, which is a kind of quasi-random low discrepancy sequencing, comprises shorter calculation periods as well as faster sampling speeds [157]. Sobol is described in [158] as more efficient in processing high-dimensional sequences. It is a sequence with the smallest prime number, 2 as the base and is able to generate a more uniform distribution, such that it can reorder the coordinates in each dimension.

As a result of the shortcomings of the pseudo-random sequence with its inconsistencies in distribution and uniformity Junaid, Bangyal [153] advise that; the Sobol sequence is a preferred method in sampling the optimisation variables.

The results for the Sobol option were plotted and are shown in Figure 6-5 as a two-dimensional allocation within the design space. As can be seen, this provided better uniformity within the prescribed area; however, upon visual inspection there was still evidence of clustering (red rings), as well as a pattern of areas not explored (green rectangles) within the design space.

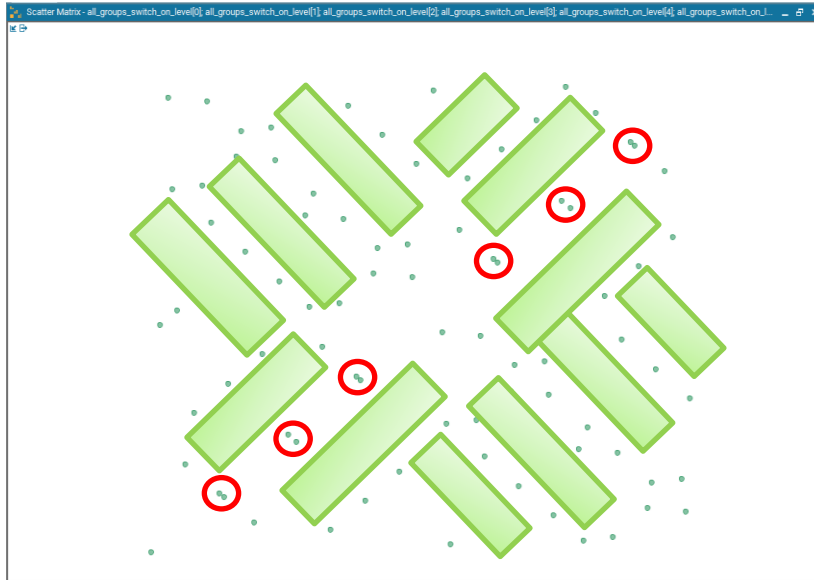

**Figure 6-5 Sobol scatter matrix, better uniformity when compared to random scatter**

### 6.6.3 Uniform Latin Hypercube

Latin Hypercube sampling methods are a form of stratified sampling, which is a method involving the division of a population into smaller groups called strata. These groups, or strata, are organised based on some shared characteristics or attributes of the members within the group. According to [159] its methodology and the samples produced reflect the integral distribution effectively.

The research has explored some of the mathematics relating to the Latin Hypercube methodology as presented by [160], [159] and [161].

As presented, assuming that:

- $N$  = the number of variables.
- $x_i$  = variable  $i$ .
- $x_{li}$  = the minimum value of  $i$ .
- $x_{ui}$  = the maximum value of  $i$ .

Then complete the following steps:

- Determine the sample size  $H$ .
- Stratify the population by dividing the definitional intervals  $x_{li}$  and  $x_{ui}$  of all variables  $x_i$  into  $H$  pieces:

$$x_l^i = x_0^i < x_1^i < x_2^i < K < x_j^i < x_{j+1}^i < K < x_H^i = x_u^i \quad (6.6)$$

Then produce a matrix ( $m \cdot n$ ) where the columns are a random arrangement of the sequence  $(1, 2, \dots, H)$ . From here, the chosen hypercube will correspond to every element of this matrix where random samples can then be taken one by one, with the resulting  $H$  samples being generated.

There are some constraints with this method, which requires a guarantee that the random numbers must belong to the divided interval. Thus, the random number  $U_j$  of interval ( $j$ ) will satisfy:

$$U_j = \frac{U}{H} + \frac{j-1}{H} \quad (6.7)$$

Where:

- $U$  = a uniformly distributed random number within the region  $[0, 1]$
- $U_j$  = the random number which belongs to region  $j (j = 1, 2, \dots, H)$

Uniform Latin Hypercube was finally inspected within the current research problem and its corresponding design space. The output plot is shown in Figure 6-6. From the above math model, this can be summarised as looking to split up the design space into cubes and then placing designs, one in each row and one in each column.

Upon inspection of Figure 6-6 there are still a select few areas where some designs appear closer together, as well as a few areas of unexplored space (green filled rings).

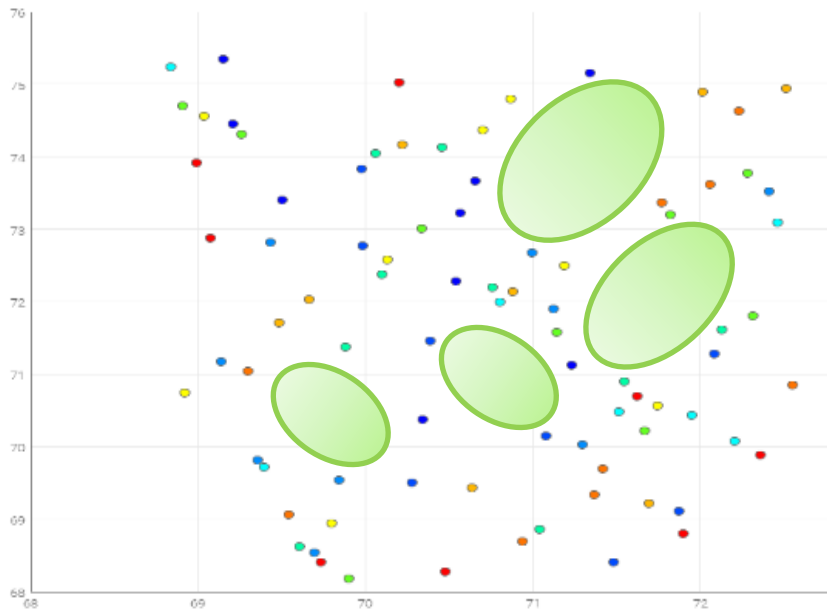

**Figure 6-6 Uniform Latin hypercube scatter matrix, some discrete areas of limited distribution.**

#### 6.6.4 Summary

Visual inspection of both the uniform Latin Hypercube and Sobol methods were not enough to make an informed decision on which one to use for the DOE. Therefore, the data were taken and plotted in a regression model scatter matrix for the first ten pump start levels. The number of ten in this case was taken on arbitrarily in order to permit the research with an initial visual response. It was highlighted that, had all 42 variables been plotted, the data would have been too granular for inspection.

Figure 6-7 through to **Error! Reference source not found.** show the scatter matrix plots (top right of the diagonal split) and squared correlation coefficient  $R^2$  (bottom left of the diagonal split) for the first ten pump start levels across Full Factorial, Reduced Factorial, Random, Sobol and Uniform Latin Hypercube. The  $R^2$  numeric value is a percentage and explains the strength of the relationship between the two variables under inspection.

Analysis follows the figures.

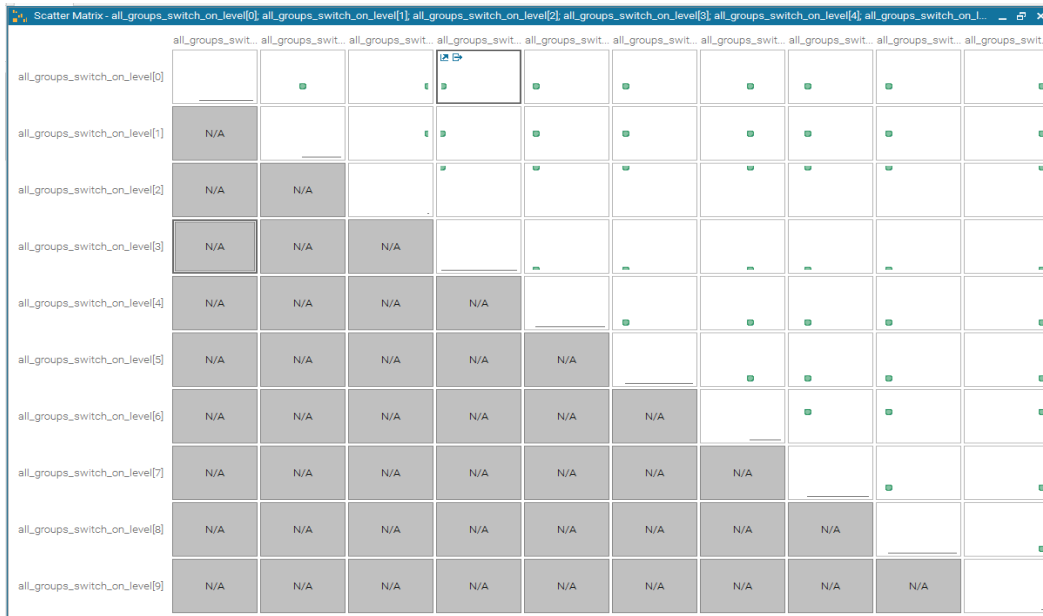

Figure 6-10 Analysis of 2-Layer Full Factorial Grouping for First 84 DOE Selection

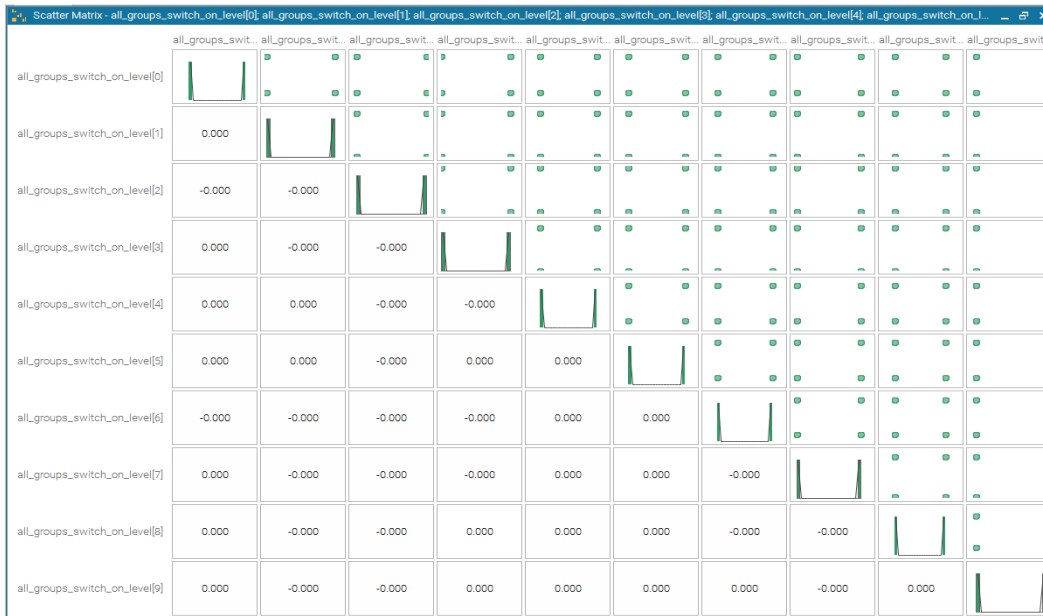

Figure 6-8 Analysis of Reduced Factorial Grouping for First 84 DOE Selection

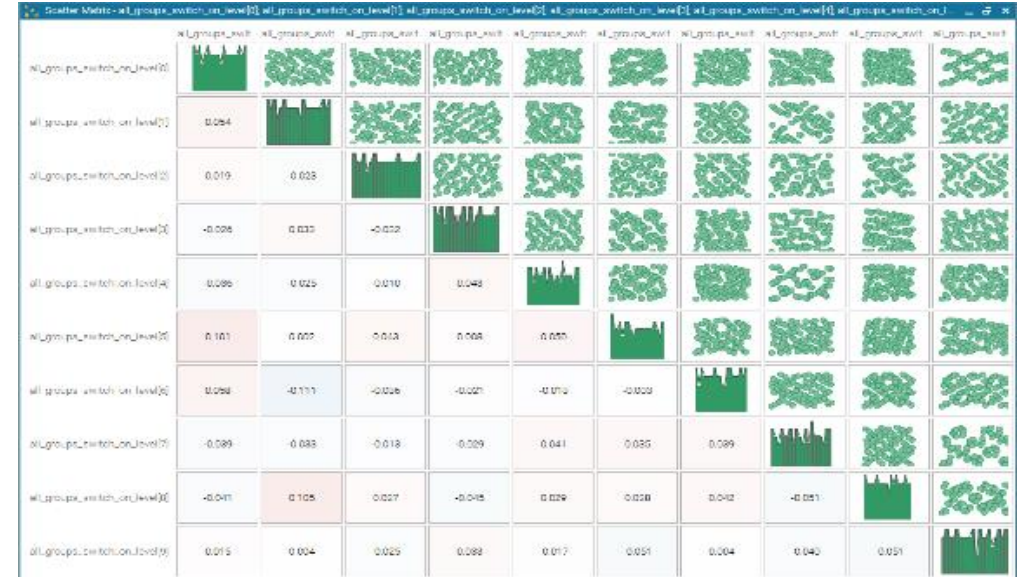

Figure 6-7 Analysis of Sobolj Grouping for First 84 DOE Selection

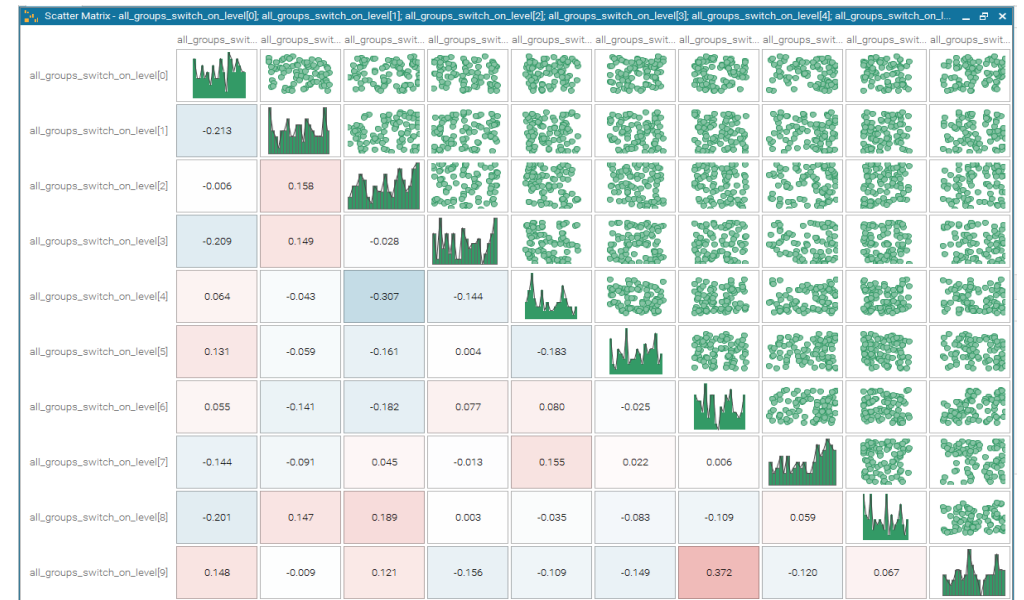

Figure 6-9 Analysis of Random Grouping for First 84 DOE Selection

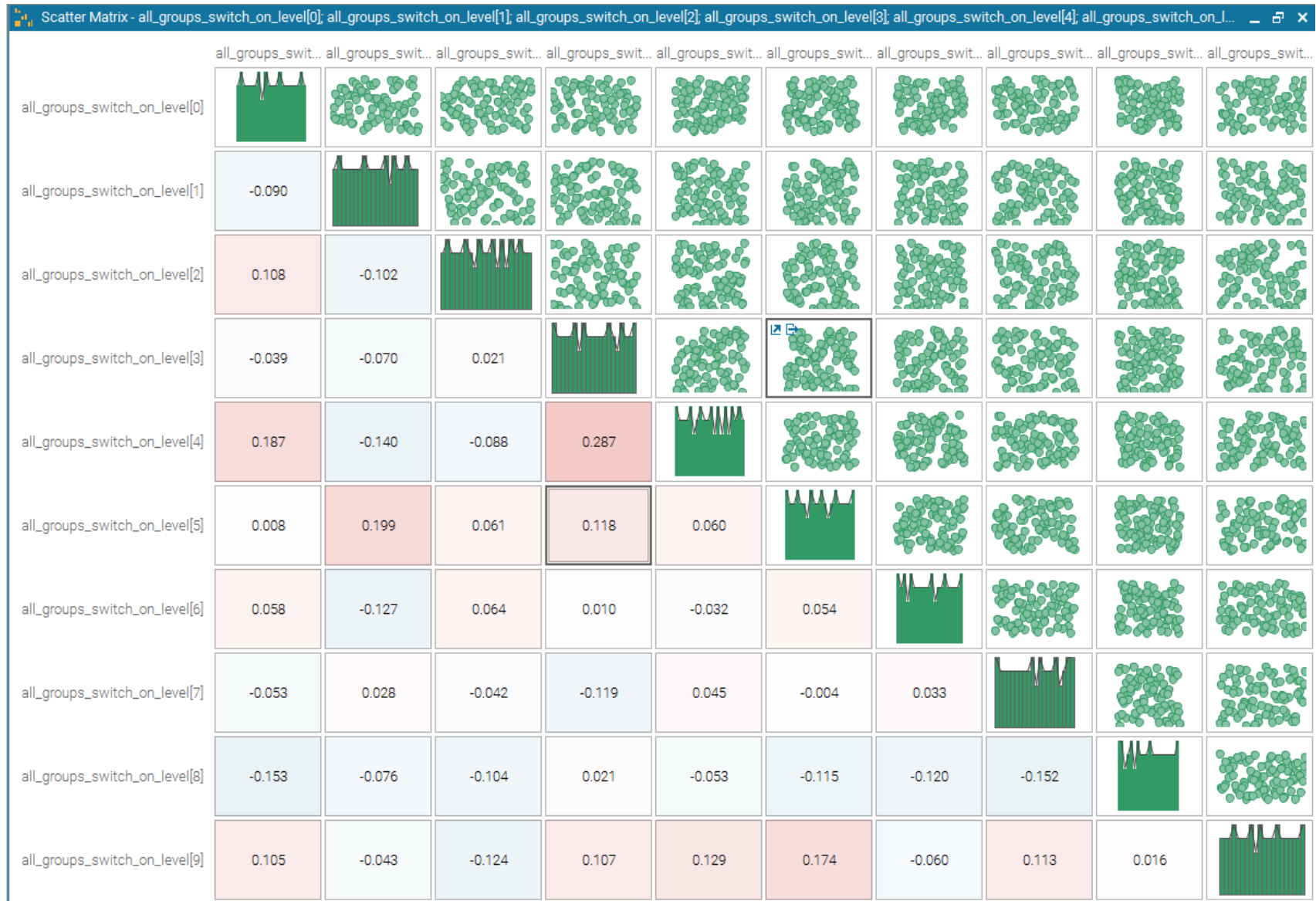
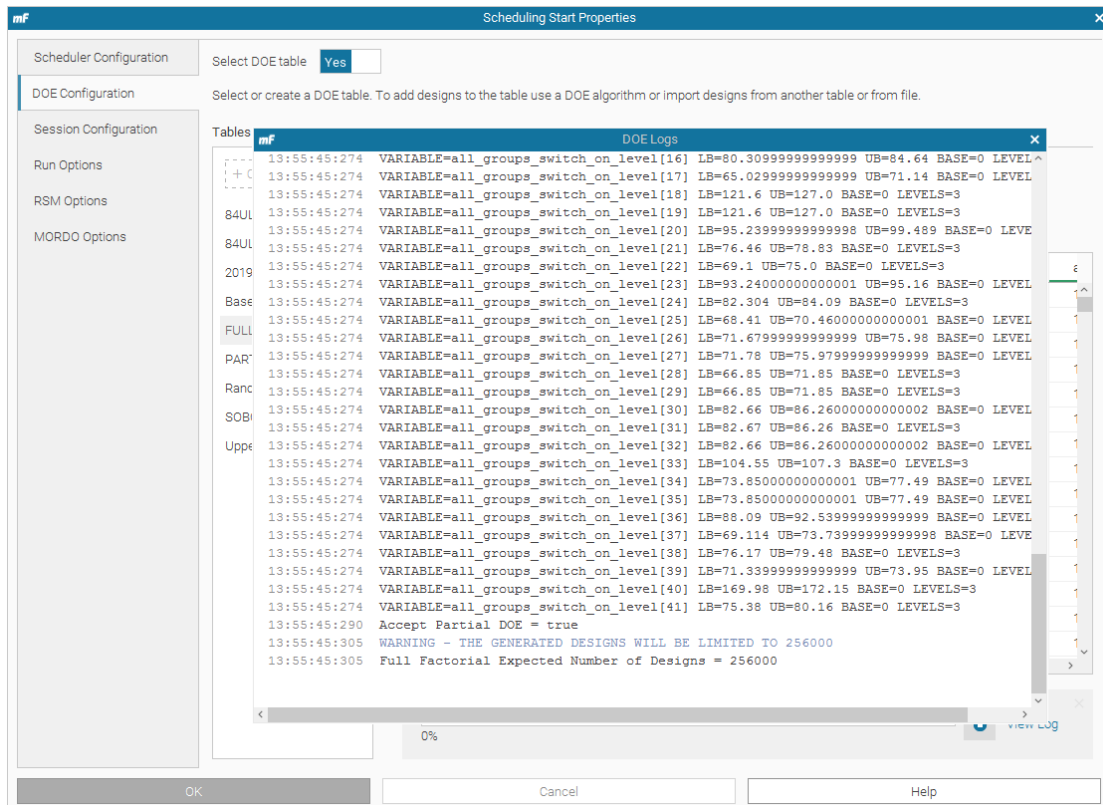

Figure 6-12 Analysis of Uniform Latin Hypercube Grouping for First 84 DOE Selection

As previously discussed, full and reduced factorial were considered however both were understood to have issues surrounding the non-linearity of the design problem and as such were predicted to struggle targeting onto an optimal design unless large levels of resource were allocated. This is confirmed further in Figure 6-7, with full factorial not even able to calculate an  $R^2$  value within the given range, which was capped by the software at 256,000, as per Figure 6-12.



**Figure 6-13 Optimisation Software Capped Full Factorial Designs**

For reduced factorial, in Figure 6-9 all  $R^2$  values came to zero and thus was also deemed by the research as insufficient for taking forward.

Visual inspection of the Random, Sobol and Uniform Latin Hypercube plots all show varying degrees of  $R^2$  values with no clear top performer. In order to select a way forward the research calculated the sample mean of the distribution.

$$\bar{x} = \frac{1}{N} \sum_{i=1}^N A_i \quad (6.8)$$

Where:



- $N$  = the number of observations within the sample distribution.
- $A_i$  = the  $R^2$  value of each sample

For the pseudo-random sample distribution shown in 6.6.1 this resolves as follows.

$$R^2 = \frac{1}{45}(-0.746) = -0.0166$$

For the Sobol sample distribution shown in 6.6.2 this resolves as follows.

$$R^2 = \frac{1}{45}(0.042) = 0.00093$$

For the Uniform Latin Hypercube sample distribution shown in 6.6.3 this resolves as follows.

$$R^2 = \frac{1}{45}(0.1) = 0.002$$

From calculation of the sample mean in the distribution for inspection, it was the opinion of the author that the design providing a better uniformity distribution in the design space was the Uniform Latin Hypercube. It was this which was taken forward for the initial creation of the DOE designs.

## **6.7 Application of Multi-Strategy Optimiser**

Following the completion of the 84 model runs based upon the parameters set by the Uniform Latin Hypercube, of which none of the 84 runs returned a feasible design (flood volume constraint breached), the research moved towards a multi-strategy optimisation tool. As the initial 84 model runs demonstrated a multidimensional response space that presented extremely non-linear results, it was concluded to start with a multi-strategy global / local optimiser. Multi-strategy automatically selects between the available strategies (evolutionary, heuristic, hybrid, gradient) and autonomously decides when to use the different type for finding the optimal point. This ensures that the first focus would be to tune in on the most effective response peak before moving onto a local strategy. PiLOPT™ is a proprietary multi-strategy optimiser and was selected as the initial solver as part of the research.

### 6.7.1 PiLOPT™ Solver

Studies in [162] present the Mode-Frontier PiLOPT algorithm as a multi-strategy self-adapting algorithm, which combines the advantages of using both local and global search algorithms within the search function. In search of the optimal solution, the PiLOPT™ solver adjusts the ratio of real and RSM-based (virtual) design evaluations based on the performance of each model run. The research in [162] cited remarkable performance, even when handling complex output functions and constrained problems. In the case of the [162] research, this was an application focusing on parallel kinematic manipulators and so there is no parallel drawn to the authors work in terms of application. However, it was of particular interest due to the multidimensional design space challenge that it addressed.

The first thing the PiLOPT™ solver completes is the training of a response surface over the initial DOE results table. Research in [163] explain that Response Surface Methodology (RSM) provides statistical models that help in understanding the interactions among the parameters to be optimised. From this RSM, the PiLOPT™ solver then started with a global strategy and ran a series of new designs. Built within its proprietary function it determined a number of designs in which to group that set of runs as a generation. From here it then retrained a new response surface over this next batch of results (which included all previous results). Following this, and with the results in the previous runs and generations it then changed strategy and applied a local optimiser, again running a number of model runs and training further RSM's over the results table.

Following the initial 84 Uniform Latin Hypercube designs, the PiLOPT™ solver added a further 114 designs to the results table, with 102 of these additions being unfeasible through a breach of the flood volume constraint. The remaining 11 feasible designs achieved a varied response in terms of the power reduction objective. These are shown in Table 6-2.

**Table 6-2 Feasible PiLOPT™ Results**

<b>ID</b>	<b>Total Pump Power (kWh)</b>	<b>Flood Volume</b>
101	14137.18	0.00
114	14143.53	0.00
120	14138.51	0.00
132	16688.79	0.00
154	21799.88	0.00
158	14187.80	0.00
161	14199.42	0.00
179	16172.38	0.00

180	11271.00	0.00
191	11288.78	0.00
198	11271.00	0.00

From Table 6-2 it can be seen that towards the final PiLOPT™ designs, the solver has managed to reduce the calculated catchment power consumption from 21,485kWh to 11,271kWh over the 31-day period. This equates to a net saving of 10,214kWh for the 31-day period.

At the time of writing the UK energy market was in a state of flux with energy prices predicted to rise exponentially throughout the year of 2022. For the purpose of a rounded costs analysis, the research will use the figures published by the [164], which state the price cap costs per kWh for electricity as £0.28 per kWh for the period 1<sup>st</sup> April – 30<sup>th</sup> September 2022.

Based on this figure, the reduction of catchment electrical energy following the initial PiLOPT batch run yields a financial return of £2,859.92 and a 47.54% reduction.

### **6.8 Local Optimisation**

Upon the PiLOPT™ significantly reducing the catchment power consumption, whilst not polluting any network node locations, and given the limitation on software availability, which was capped at 90days, the decision was taken to convert from the multi-strategy optimiser to a dedicated local solver. This was also done as the research had concluded that the PiLOPT™ had landed upon the optimal peak within the design space and so switching to a local optimiser would be preferential in extracting any further potential savings.

To visualise the requirement, the research presents a single inverse peak shown in Figure 6-13. This plot has been created with arbitrary axes values for the purpose of explanation only. As discussed, the research had concluded that the multi-strategy solver, the PiLOPT™ had located the optimum peak for exploration and had subsequently switched from global to local search techniques. The research now wanted to use a different algorithm in search of the local minima on this peak. I.e., the chosen algorithm would look to optimise as close to the point in the design space that represented the convergence of  $x=0, y=0$  in the below plot.

NOTE: The values in the actual application were not expected to equal  $x=0, y=0$ , this is for explanatory purposes only.

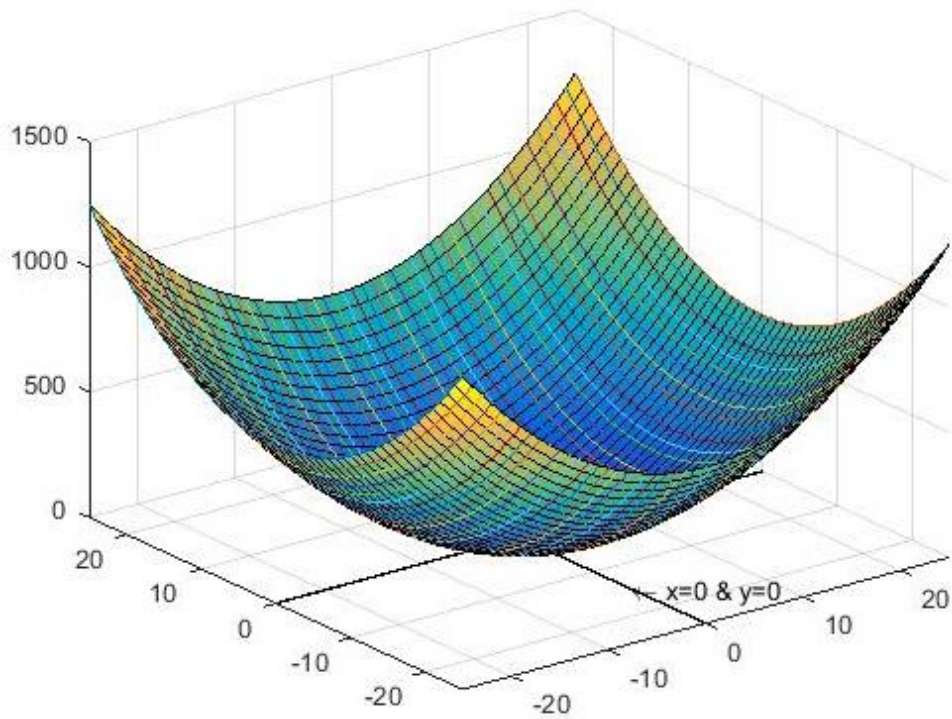

**Figure 6-14 Example Inverse Peak**

The research finds that for solving local minimum optimisation challenges, some of the previously discussed techniques highlighted in section 6.3, including Gradient-based and Newton-Raphson based methods are extremely common and have yielded excellent results.

### 6.8.1 Gradient Descent

For gradient descent [165], minimise  $f(x)$

$$x_{n+1} = x_n - \lambda \nabla f(x_n) \quad (6.9)$$

Where:

- $\lambda$  = the step size.

With  $\lambda$  set as a constant some issues can occur. Namely, if the constant is too small the equation will not take large enough steps when  $f(x)$  is in a flat area of the design space, and the optimiser can become caught in a loop within this region. Conversely,

if the step size constant is too high, and  $f(x)$  contains some steep gradients then the optimiser will tend to take too large a step or steps, thus not resolving upon the target minima.

### 6.8.2 Newton-Raphson

For the Newton-Raphson method [166, 167], the solution avoids the oscillation issues by solving the stationary point of  $f(x)$ , i.e., the first derivative  $f'(x) = 0$

$$\nabla f(x_{n+1}) = \nabla f(x_n) + (x_{n+1} - x_n)^T \nabla^2 f(x_n) + h.o.ts = 0 \quad (6.10)$$

Where:

- $h.o.ts$  = any higher order terms.

In neglecting the higher order terms, the following is presented:

$$x_{n+1} = x_n - (\nabla^2 f(x_n))^{-1} \nabla f(x_n) \quad (6.11)$$

This method uses the inverse of a Hessian matrix  $\nabla^2 f(x_n)$ , (i.e., the functions curvature) instead of a constant step size  $\lambda$  as per the standard gradient descent method, to reach the minimum point.

Note, the Hessian matrix of the function  $f(x)$  is shown as:

$$H = \nabla^2 f(x_n) = \begin{bmatrix} \frac{\delta^2 f}{\delta x_1^2} & \frac{\delta^2 f}{\delta x_1 \delta x_2} & \cdots & \frac{\delta^2 f}{\delta x_1 \delta x_n} \\ \frac{\delta^2 f}{\delta x_2 \delta x_1} & \frac{\delta^2 f}{\delta x_2^2} & \cdots & \frac{\delta^2 f}{\delta x_2 \delta x_n} \\ \vdots & \vdots & \ddots & \vdots \\ \frac{\delta^2 f}{\delta x_n \delta x_1} & \frac{\delta^2 f}{\delta x_n \delta x_2} & \cdots & \frac{\delta^2 f}{\delta x_n^2} \end{bmatrix} \quad (6.12)$$

By doing this, during the flat areas of the function (small curvature), it employs high gains (step size) and in areas of steep drops it employs smaller step sizes. A further

advantage of using curvature is that if  $f(x)$  comprises “narrow valleys” then this method can reduce the motion along the “steep cliffs” and concentrate more “within the valley itself”.

In general, the Newton-Raphson method is a lot faster than gradient descent because it employs the curvature information of the function.

A drawback of the Newton-Raphson method is that the convergence is heavily reliant upon the initial condition, as well as the positive-definiteness of the Hessian Matrix [168]. Typically, the closer the initial condition is the minimum point, the better the chance of convergence would be. Further, if the Hessian matrix is not positively definite, then the search direction may not point in a descending direction and if the Hessian matrix is singular, it stops working. It may also comprise other failure modes, such as being trapped in a loop and diverging from the solution. The calculations used to solve each Hessian matrix are also extremely time consuming when the size of vector  $x$  is large. Each Hessian matrix requires its internal constituent parts to be processed per vector and so the more vectors there are the greater the load on the processing of the Hessian matrix.

### 6.8.3 Levenberg-Marquardt

In order to liberate the positive aspects of the aforementioned methods, the Levenberg-Marquardt method combines elements from the gradient descent and Newton-Raphson method [169].

$$x_{n+1} = x_n - (\nabla^2 f(x_n) + \lambda I)^{-1} \nabla f(x_n) \quad (6.13)$$

Where:

- $I$  = the identity matrix and is the same size as the Hessian.

When  $\lambda \rightarrow 0$  the Levenberg-Marquardt method tends towards the Newton-Raphson method. Conversely, when  $\lambda \rightarrow \infty$  it tends towards the gradient descent method using small step sizes. If the gain / step size is sufficiently large and even if the Hessian matrix is not positively definite, the matrix  $H + \lambda I$  can be positively definite and thus, will guarantee a reduction in the functions value.

If in each step the update demonstrates that the cost function is going down, i.e., implying that the curvature is helping, it can be accepted and a reduction of  $\lambda$  can be applied (usually by a factor of 10). This is done to reduce the influence of the gradient descent component. Conversely, if the cost function starts to increase, then retracting by one step and increasing  $\lambda$  by a factor of 10 is applied.

The Levenberg-Marquardt will therefore, operate faster than a traditional gradient descent method but will display better stability than the Newton-Raphson method [169].

Further, the author found that the Levenberg-Marquardt algorithm is one of the most widely used nonlinear least squares algorithm. As well as comprising the advantages of gradient descent and Newton algorithms, which have high convergence speeds, it also has high precision and good noise suppression effects [170].

At this point, and with advice taken from the software provider, the Levenberg-Marquardt solver was selected from the list of available local solvers in the modeFRONTIER™ package. Within the package, the Levenberg-Marquardt solver locates the local minimum of the objective function expressed as the sum of squares [171] and is good at curve fitting, minimising the error between two curves. For each new design it will make a very small gradient step change to one of the manipulated variables, one at a time, and re-runs the model each time. Following each manipulated variable being trialled, the solver will then make a larger gradient step change and analyse the preceding results.

With this research the target curve is a flat line across the X-Axis as it is a single objective with electrical power equals to zero. Within the configuration of the solver the gradient step size was determined via percentage rather than absolute. This was selected so as to protect against differing orders of magnitudes. The Levenberg-Marquardt solver was baselined with the pump start configuration parameters derived from the successful PiLOPT™ design that achieved the lowest power consumption so far (11,271kWh), which was design 198 shown in Table 6-2.

The solver ran 247 further designs which included five large gradient step changes during the cycle. On the 186th design (383rd overall) it hit the optimal design, with a calculated power output of 11,245kWh.

In order to inspect the data, Figure 6-14 and Figure 6-15 were taken directly as an output from the modeFRONTIER software. They show the overall results of the optimisation process and also omits any unfeasible designs by not identifying with a marker on the data point. Figure 6-15 displays the data in the form of feasible (zero flood volume) and unfeasible (flood volume >0) designs.

As can be seen the initial run of 84 Uniform Latin Hypercube designs have no markers as they were all unfeasible. The PiLOPT™ marked by orange shows the 11 feasible designs in 113 runs.

NOTE: Before the research ran the Levenberg-Marquardt solver the original baseline data from the initial model was run as it had not previously been included in the master results table, hence why it is not the first plot (Ideally it should have been but to rerun the entire programme again would have been 16.5days of license time consumed. This is marked with a red X.

The long string of green are the Levenberg-Marquardt derivatives (the small gradient step changes), with the five large gradient step changes marked as black. The optimal design is 383 and is highlighted in bright green. Note, other than a couple of outliers within the Levenberg-Marquardt method, all model runs were feasible, hence the long string of green dots.

The blue dots are the NSGA-II model runs, which are discussed in further detail in section 6.9.

To present the data in an alternate way, Figure 6-17 was also generated using the raw data export which is contained with Appendix 6. The graph colour schemes each of the solvers. The first batch, in red, shows the initial DOE run. It then moves into green, which displays the data for the PiLOPT™ batch. Orange then dominates the chart, depicting a flat area where the Levenberg-Marquardt solver was attempting to (and with some success) liberate further energy savings from the system. There are a few strands of dark blue, this is where the Levenberg-Marquardt algorithm made larger jumps within the design space in search of the local minima before reverting to smaller gain settings (as per equation 31). Magenta is the final colour which shows the NSGA-II (discussed in section 6.9).



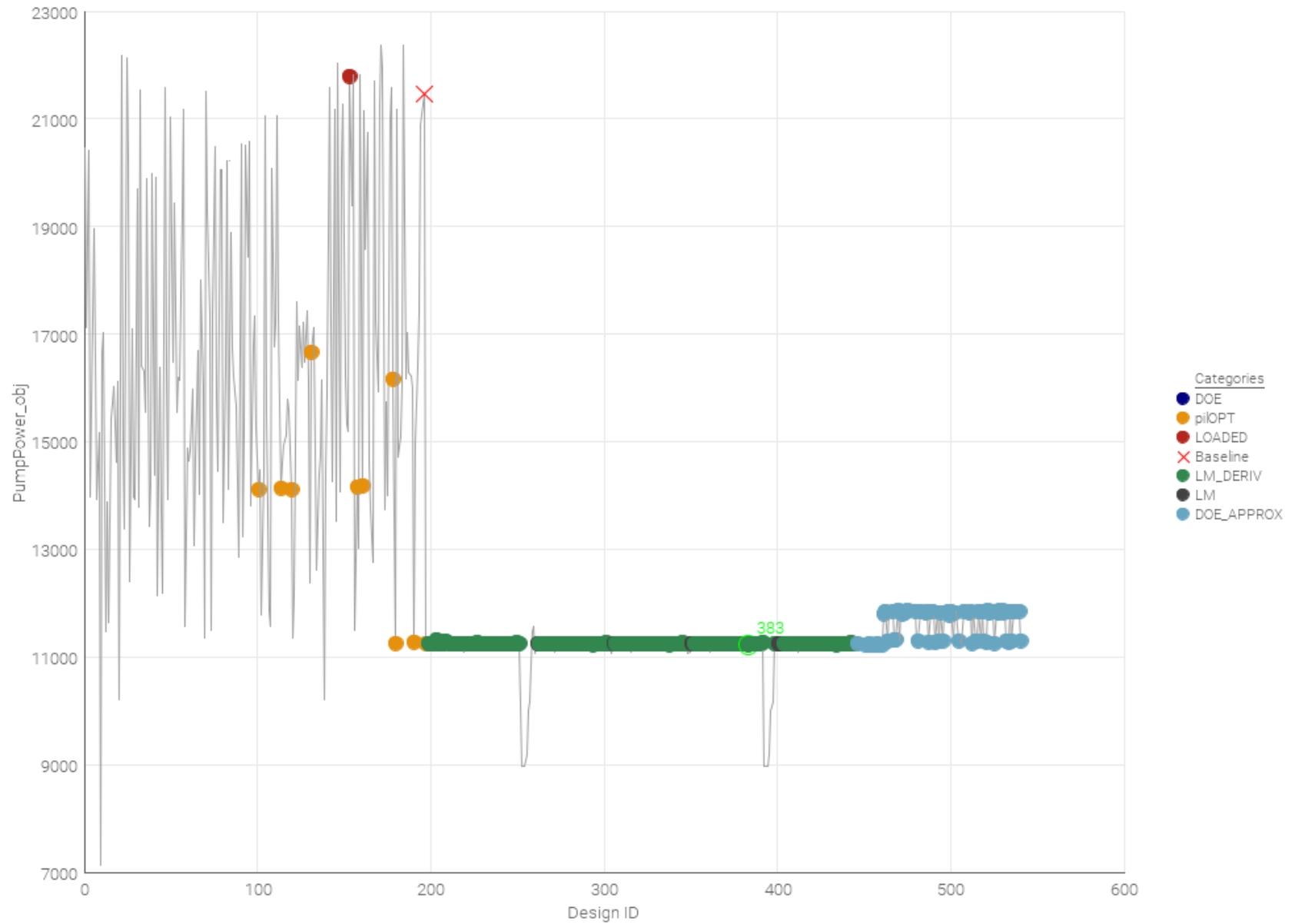

Figure 6-15 Final results plot feasible designs per strategy, taken from modeFRONTIER™ results

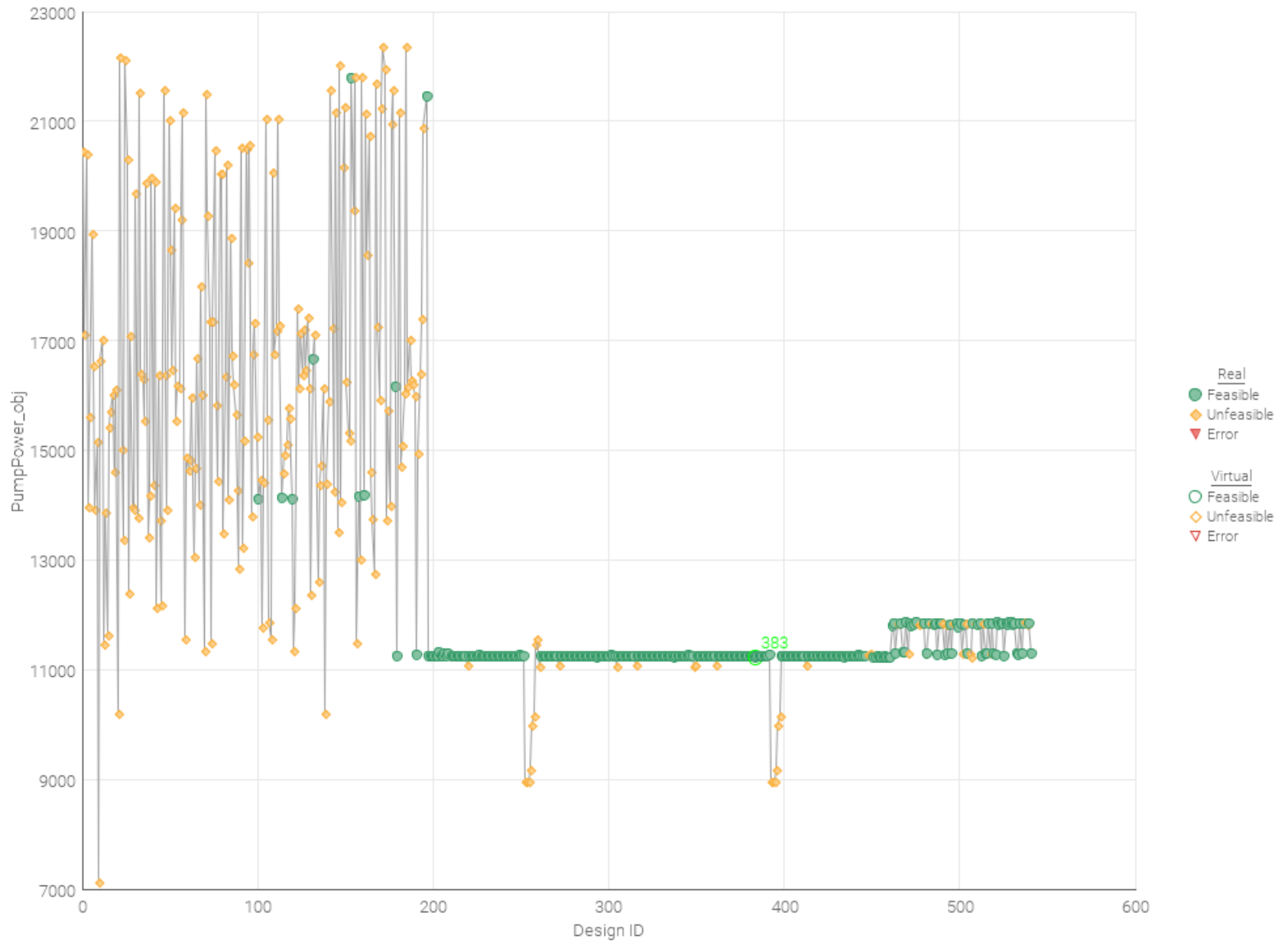
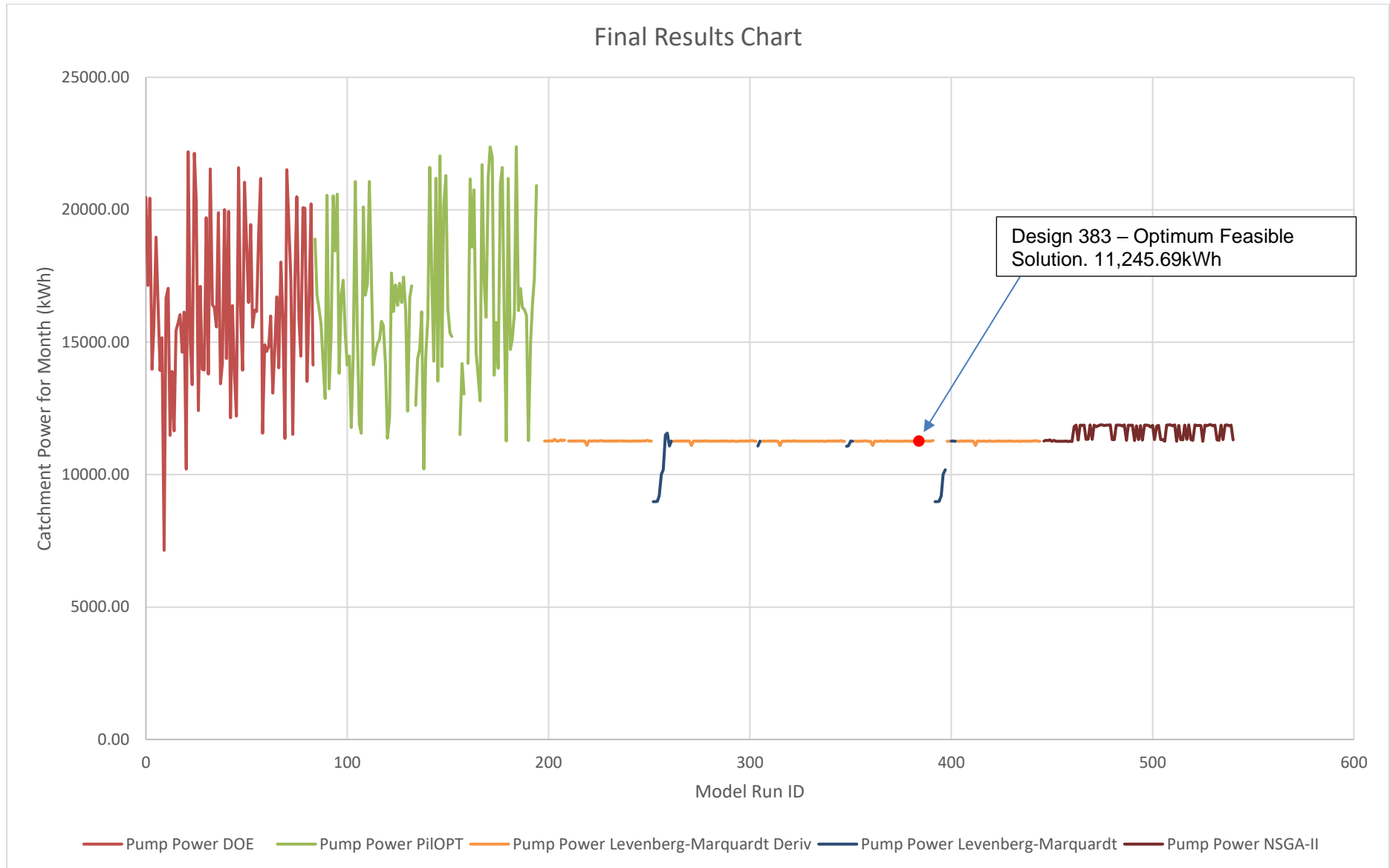

Figure 6-16 Final results plot feasible and unfeasible designs, taken from modeFRONTIER™ results



**Figure 6-17 Final Result Chart from Raw Data – Plotted by author from results**

## **6.9 Additional Global Strategy Test**

During the course of the optimisation and as the Levenberg-Marquardt algorithm appeared to be hovering around the same point, it was concluded by the research, along with advice from the software vendor that it had achieved its optimal design output. In order to gain further insight, and because there was some limited time available with the modeFRONTIER development license, the research looked at trialling a further solver to see if any additional gains could be made.

Research in [172] and [173] presented the NSGA-II algorithm, which is a genetic type global strategy and is one of the most popular multi objective optimisation algorithms. In conjunction with the positive results presented in the literature, and from advice from the software vendors subject matter expert, this was chosen and loaded with the optimal design parameters from the Levenberg-Marquardt solver as its baseline.

The results from the NSGA-II solver are shown as blue dots on Figure 6-15 and a magenta line in Figure 6-17. As can be seen, the solver seems to hover around two areas without making any additional energy reductions. Further inspection shows that all NSGA-II designs were feasible, which suggests the solver was constrained within a boundary condition that appeared to be restricting it from making any impactful adjustments to the design space.

As a result, the overall optimal design from the research remained as per the <sup>383</sup>rd run using the Levenberg-Marquardt algorithm.

## **6.10 Final Savings**

The final electrical energy savings yielded from the research are as follows: A combination of multi-strategy and Levenberg-Marquardt algorithms reduced the power consumption from 21,485kWh to 11,245kWh, a net saving of 10,240kWh for the 31-day period. Converted into monetary values, and using a business tariff rate of £0.28 / kWh, this equates to a potential capital saving of £2,867.20/month for the catchment trialled.

When comparing the Levenberg Marquardt additional local optimisation schedule against the initial proprietary PilOPT™ solver, this managed to reduce the catchment power demand by a further 26kWh in the month, which equates to £7.28 for the period.

To recap; the final calculated electrical energy savings are as follows:

- The baseline power output of validated hydraulic model - 21,485kWh / month
- PiIOP™ solver reduced this to 11,271kWh / month
- Levenberg-Marquardt algorithms further reduced the power consumption from 11,271kWh / month to 11,245kWh, an additional saving of 26kWh for the 31-day period.

Converted into monetary values and using a business tariff rate of £0.28 / kWh, this equates to a potential capital saving of £2,867.20 / month for the 10,240kWh reduction.

When comparing the Levenberg Marquardt additional local optimisation schedule against the initial proprietary PiIOP™ solver, this managed to reduce the catchment power demand by a further 26kWh in the month equates to £7.28 for the period.

As a percentage, this equates to an overall net reduction of 47.7% for the Bordon catchment. Applying this same percentage to the target water company's entire wastewater pumping operation, with an annual bill of approx. £13m / annum, a potential theoretical saving of £6.11m / annum, is available through optimising the wastewater catchment control.

# Chapter 7

## Conclusions and Recommendations

This final chapter summarises how the established research aims and objectives have been met, with detail presented against each objective. Following this, the author reflects and discusses the conclusions obtained as a result of the project before moving into the contributions towards knowledge. Some of the limitations presented to the project are highlighted before closing with recommendations for future work following this project.

### *7.1 Research aims and objective achievements*

In reviewing the research objectives posited, objective one was met through a detailed critical analysis of the implementation of an estate-wide SCADA upgrade within a UK water utility. The second was met by identifying the Bordon wastewater catchment in Hampshire in the South of England via clustering techniques.

The **third** objective has been met in several ways; firstly, the author visited every pumping station site during the research to physically survey the assets. This included:

- Inspecting the electrical / telemetry equipment and obtaining the pump systems' electrical nameplate information.
- Inspection of the wet well on-site by lifting the cover hatches. From here, detailed measurements were taken from inside the well.
- The employment of a third-party survey company to take spot heights of the top of each wet well.

Following the physical surveys, the research then modified the hydraulic model for the Bordon wastewater catchment to convert all prior assumed parametric data into real values extracted from the survey.

In addition, the research then loaded a Lidar overlay on top of the catchment to enable the pumped rising main to be modelled. Prior to this, the model comprised no rising main information, and as such, any frictional and / or statically dominant factors had been omitted.

It is the opinion of the author that following this detailed survey and upgrade of the Bordon hydraulic model, this is now the most accurate hydraulic model in terms of correlation with the real-world assets that the company has.

The final objective was fulfilled by deploying the modeFRONTIER software package, which provided an API link into the Infoworks™ environment. From here, the research was able to apply the mathematical calculations for electrical energy as an output function of the catchment and set an objective function to reduce this energy through a combination of multi-strategy and local optimisation techniques.

## **7.2 Conclusions**

### *7.2.1 Control Room Strategy*

The research concludes that; to enable integration and optimisation strategies with the best chance of success (within an incumbent physical infrastructure), the supporting SCADA infrastructure would need to be aligned to a singular product and platform, thus allowing for scalability of the output. I.e., an application in one area of the business running Platform A will require engineers to have specialist knowledge of the product and its interoperability with any third-party optimisation systems. If another area runs Platform B, this would require additional resource knowledge to maintain the same level of interoperability, which is hugely inefficient. Moreover, if products are not aligned then some of the third-party optimisation applications may not provide cross-compatibility, and as such, some of the estate may not be in scope for optimisation. At this point, the business would need to decide whether to omit these areas from optimisation or invest in additional compatible systems, neither of which are ideal solutions.

In addressing the above concerns, and with an appetite to liberate the data the infrastructure provides, the target water company within this research project did standardise their SCADA estate, which gleaned huge learnings in terms of the deployment of change to the control room. This change has informed the research on any future change that would inevitably ensue from a switch to an optimised, dynamic control profile. The type of optimised control profile that would be deployed from the output success of the fourth objective of this research.

There is an increasing awareness among the control room community regarding the importance of human factors and that a key component in acceptance of systems when delivering new operational technologies, are the individuals who will be tasked with

using them. The automation of any optimisation sequencing, that has the ability to actuate assets in the field, must be delivered with suitable training such that operators and maintainers can understand the changes being made, intervene with a high degree of certainty when conditions change, have the tools to regress to a prior known steady state from any automated / optimised control, should the need occur.

Further, the research concludes that the deployment of any optimisation strategy should be done without the use of black-box systems and should employ the use of the incumbent control infrastructure. I.e., do not install a third-party box within a control loop that takes inputs and manipulates outputs if it cannot be inspected, understood and maintained by the company's workforce. Doing so will lead to widespread rejection from any project handover. Instead, take the learnings from any optimisation project (which, of course can be highly complex in their construction and application) and look to deploy in the form of profiles or dynamic code execution that reside in the company's existing control assets, PLCs, SCADA, HMI's etc.

In terms of the frontline operators and from an organisational perspective, the research concludes that there is a strong correlation between the resistance to change and the implementation success which was experienced during the target water company's SCADA upgrade programme. With any future optimisation deployment, sensitive management must be considered at both an individual and wider group level. Engagement should always be sought as early as possible and be fully inclusive of all potential end users. Prior analysis of behaviour related to technological changes in the workplace environment will lead to a better understanding of how integration could be delivered more effectively and without such resistance to change. Human factors must be factored into any major operational technology change.

Regarding the common objects and standardised SCADA, the research further concludes that doing so assists in liberating the data and generates greater value from this data across the Purdue stack. This is achieved by the deployment of scalable, transferable information models that interact seamlessly across all business units and, thus, reduce analytical resource efforts by enabling templated query structures.

### *7.2.2 Catchment selection*

The successful selection of the Bordon wastewater catchment was concluded using the K-Means++ algorithm, which was based on the low complexity of the data set being inspected, and thus ease of application. The algorithm was employed to take each



wastewater pumping station's latitude and longitude coordinate (as an X, Y graph plot) and create cluster groups within this design space.

The primary driver for using the data pertaining to telemetry outstations that had previously been upgraded to controllable assets was such that any successful implementation from the fourth objective would require the least amount of capital investment. The use of clustering techniques successfully identified the Bordon wastewater catchment and highlighted (through the use of a silhouette function); that within this cluster, 19 out of the 33 pumping stations had already been upgraded to newer telemetry assets, along with always connected xDSL and cellular communications. Using estimates from today's current economic models from with the company, a wastewater pumping station telemetry upgrade will cost in the region of £50k per site. Core investment to get Bordon ready for optimised control deployment was, therefore, estimated at £700k. The next catchment within the investigation that identified a good number of outstations upgraded was Crawley (Gatwick), here 18 outstations were identified; however, this was within a catchment of over 50 pumping stations and, as such a price tag exceeding £1.6m to replace the necessary assets. The research concludes that the use of simple Matcode algorithms can be employed to cluster datasets in the hunt for an optimal investment opportunity.

### *7.2.3 Model Validation*

Following the physical surveys on site and through the validation of the data taken from these sites versus the data contained within the baseline model, the conclusion presents; there are large amounts of assumed data loaded into a water company's hydrological model that have been collected from prolonged periods in the asset's lifecycle and from times before these models even existed. That presents a challenge going forward in terms of the deployment of a scalable optimisation solution that requires hydraulic model interaction.

To highlight, these wastewater catchments and their interconnecting piping systems have been constructed and buried underground for many years, in some cases near 100 years, going in with the original construction of the housing / commercial / industrial developments they serve. Notwithstanding, the data the model contains are extremely well constructed and use sufficient generalised spot heights for the catchments characteristic mapping. This allows the modelling teams to execute their day-to-day activities with great precision, including planning for large rainfall events, enabling system inspection for the addition of new construction developments, failure mode

simulation etc.; however, for high-resolution modelling of the pumps and their electromechanical characteristics, these models will require a significant level of investment to get them towards the level that this research got the Bordon model.

To summarise with some metrics taken during the project, the physical survey of the Bordon catchment (comprising 33 different physical locations) took 10 days for 2 people. The third-party contractor taking the spot heights so the research could convert real-world parameters to mAOD took a further 4days for two people. The Lidar overlay and modelling of all rising mains with the hydraulic model took the author 15 days. The upgrade of all pumps within the hydraulic model as a result of the data taken from the site took the author 4days. Thus, for a catchment of 33pumps, an effort of 47person days was required to get the model into a validated condition such that it reflected the real-world configuration.

The target water company this research has worked with has an asset base that comprises over 3000 sewage pumping stations; in order to get the entire company's hydraulic model calibrated to real-world data, an estimated investment of 4,272 person days would be required (based on an approx. 1.42person days per site). Following this, any changes to a catchment through growth schemes, asset upgrades, or other factors, would need to be mandated such that they feed-forward the change data to the modelling team. Failure to do so would lead to the validated models becoming outdated, which in turn would cause any optimisation output (in the form of control executable) to deviate from the system it controlled.

The above is not an insurmountable task, far from it; it is the author's opinion that to improve asset control, make smarter decisions on catchment management and to one day achieve a fully autonomous system that is designed to protect against pollution whilst using the optimal minimum amount of energy, then the above work is a necessary investment.

#### *7.2.4 Wastewater Catchment Optimisation*

The research has successfully deployed optimisation algorithms integrated directly within a water company's wastewater hydraulic model. The target objective, which was the reduction of electrical energy, whilst obeying the zero-flood volume constraint, has been executed, and the research is satisfied with the results yielded from the exercise.

The research acknowledges that for the purpose of this project, the pump start level constraints in which the model was allowed to operate were capped at the same height

as the top of the wells in which they resided. What this meant is that although the zero-flood volume constraint could be obeyed (and was), what wasn't available as part of the feasible simulations were any threat indicators in terms of 'how close' a well or manhole was to spilling. What this meant is that for a feasible run that was successful in reducing energy, there could have been wastewater extremely close to the point of spilling and as such should any sudden change come from external influence, then the catchment may not have been able to react in time to prevent pollution.

The research further concludes that in a real-world application, the operations teams who own, operate and maintain these wastewater catchments would not accept such a high level of risk within their area. To allow a wet well to get to a point where any additional flow would cause a spill is an intolerable risk. The research demonstrates the maximum theoretical saving possible within the simulation and that through optimisation techniques integrated with a validated model, sufficient electrical energy savings can be made.

Considering an arbitrary risk reduction of 50%, in which the maximum pump start level is set to halfway between the baseline start level and the top of the well, it can be roughly assumed that the 47% saving would reduce to approx. 23.5%, if this was rounded down to 20% to factor in some additional losses by not having all of the well height available, then this would still be a significant energy saving for the water company whilst operating within a tolerable risk envelope.

This research project successfully concludes that through the use of optimisation strategies, including multi-strategy (global / local) and local search techniques, it is possible to reduce the electrical energy within a wastewater catchment by exploiting the natural capacitance that exists within the network and without having to invest in additional storage (tanks).

### **7.3 Contribution to knowledge**

- (i) **The knowledge presented on control room acceptance** with regards to the change in an operations team's environment, including the original changes made through the standardised modular approach when deploying a companywide SCADA upgrade. Additionally, recommendations on engagement for any subsequent change programme that brings impact to the control room.

- (ii) **The use of clustering tools** provided a novel approach in enabling the research to make design decisions on where to target an optimisation project. This would lead to an informed and efficient asset upgrade scheme. Additionally, it achieved this with the minimal amount of site data, namely the latitude and longitude coordinates of each site.
- (iii) **The validation of a wastewater hydraulic model with real-world data**, inclusive of revised heights for all wet well parameters, including the start and stop levels of the pumping assets. These had previously only ever been configured locally on-site and with relation to the local bottom reference of the wet well. Whereas the research has now extracted these, converted them into mAOD and updated the model to replicate the onsite controller within the model. Further, Lidar overlay data was added so that the system could have a physical rising main modelled, thus contributing frictional losses to the static losses within the system and providing a more accurate picture of the system curves that go towards the power output.
- (iv) **The configuration of a wastewater hydraulic model to include head / discharge data** provided a novel output from an industry-leading software provider that enables end users with the tools to calculate electrical energy per pump node across various simulations. Furthermore, the remodelling of the wastewater system profiles will enable any participating company to make better informed investment decisions, with higher precision on resource utilisation being a benefit and with a focus on addressing the water / energy nexus with a positive reduction in emissions.
- (v) **By using integration objects in a novel way that employ the combination of proprietary algorithms, hybrid gradient descent and Newton-Raphson optimisation in the form of Levenberg-Marquardt techniques**, it is proven possible to exploit a wastewater catchments natural hydraulic capacity through the application of changing when and at what level an individual pump starts. In addition, a new control framework will also permit network operators to develop an optimal operating strategy for greener control of the pumped assets in order to ensure sustainability and minimal environmental impact of the target catchments.

## **7.4 Limitations and suggestions for future research**

### *7.4.1 Software and Hardware Availability*

One of the primary limitations that the research was subjected to, and in the author's opinion, was the availability of processing power and license time within the computational resource. As discussed in section 6.4, the system used was a Dell PowerEdge server hosting a 16V-CPU Windows operating system. Prior to obtaining this server, which was a redundant SCADA server kindly issued by the water company, the research had been running the Infoworks™ modelling software on a laptop. These model runs had been taking between 4-8hours per run, with many of them crashing and timing out. The introduction of the Dell PowerEdge server saved the research from complete failure as it brought the model runs down to an average 2hours and 4mins, with successful runs of approx. 99%. This allowed the research to continue and arrive upon a successful outcome. The author notes, however, that through the access to cloud resources, that could unlock unlimited multi-threaded processing, the model execution times could have been reduced significantly further, and that would have permitted the research with additional, extremely valuable, license time to trial additional optimisation strategies. The UK software vendor of the modeFRONTIER package had issued a time-restricted (90day) license to run the software at a cost of £16k; therefore, any time taken during the optimisation is always completed with a lens of cost focus. When considering each model runs average time, this equated to 46.5days of time consumption during the period in which the 541 model runs were generated (as per Appendix 6). Note, although this only equates to 50% of the available license time, this did not include the time required to construct the optimisation workflow, test the workflow, analyse results between strategies and then extract results thereafter. The author recommends that future research explore cloud computing resources in providing the core infrastructure for model runs.

A further limitation noted by the research was the power output as a function of electrical energy from the Infoworks™ software package. Although pump power was available, and that is the power applied by the impeller on the body of water to make it motive within the system, there is no parameter output for pump electrical power. It is the author's opinion that, along with the correct configuration of the model pump head / discharge curves (as completed by this research programme), pump electrical power would be an extremely valuable output as a default offering from the software package. In terms of this research project, this limitation was overcome through the use of the power calculation scripted within the optimisation model, as shown in Appendix 5. This

essentially performed large matrix operations to calculate instantaneous electrical energy per pump, per time period, using the three outputs; flow, upstream and downstream head, and applying some efficiency constants. Having electrical energy as a direct parameter output from the software package would have eliminated the matrix operations within the optimiser and could have significantly reduced the model run time further.

As previously discussed in Chapter 3, electrical sub-metering can play a valuable part in the measurement of granular site systems and their electrical loads. For future validation of a hydraulic model, such as the one presented by the author, electrical sub-meters installed on each pump would be of great benefit.

#### 7.4.2 Optimisation Algorithm Deployment

One limitation discovered with the Levenberg-Marquardt algorithm was that as it utilises a sum of squares, the optimiser appeared to prejudice the pumps with larger squared values even though the actual per unit power increase could have been the same across the asset. In some cases, it might even prejudice a pump whose power saving was less than another due to the order of power (i.e., a 1kW pump vs a 10kW pump). The optimiser assumes that there is more scope for achieving the objective function by targeting these larger KW pumps when perhaps they may not be the asset for optimisation as they are at their max boundary. With additional time, the research recommends that any future study in this field explores a secondary round of modelling that potentially removes pumps (by setting their start levels to static values and having the algorithm ignore them by treating them as a constant).

With a very small window of time remaining on the license, the research sought to investigate the sensitivity analysis of the initial baselined Uniform Latin Hypercube results. This was done for the top contributing pumps for 90% of flood volume and 90% of pump power. Figure 7-1 and Figure 7-2 show the sensitivity analysis plots for the initial 84 designs and cover both flood volume and pump power consumption. The pumps are listed in order of contribution to the respective characteristic.

**Table 7-1 Sensitivity analysis from initial ULH84**

<b>Pump Contributing to Flood Volume</b>	<b>Pump Contributing to power consumption</b>
Pump 16	Pump 7
Pump 39	Pump 1
Pump 4	Pump 16
Pump 41	Pump 21
Pump 11	Pump 37

Pump 20	Pump 35
Pump 27	Pump 0
Pump 10	Pump 15
Pump 15	Pump 40
Pump 37	Pump 28
Pump 24	Pump 14
Pump 38	
Pump 28	

Removing the duplicates from across each column, there are 20 individual pumps that make up 90% of the catchment's characteristic response in terms of the objective function and the flood constraint. It would be recommended that any future research investigated this sensitivity analysis before determining whether to deploy dynamic configuration within all control variables, as by reducing this would inevitably help with model time execution.

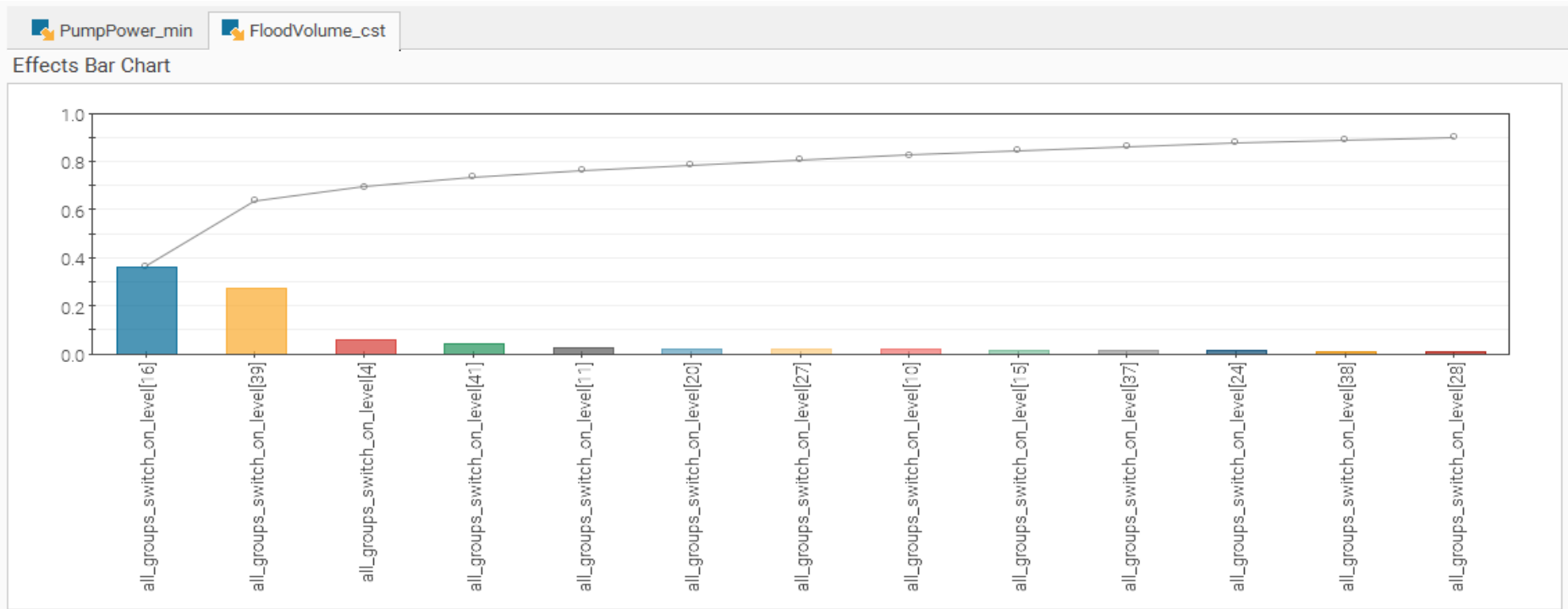

Figure 7-1 Sensitivity analysis for flood volume



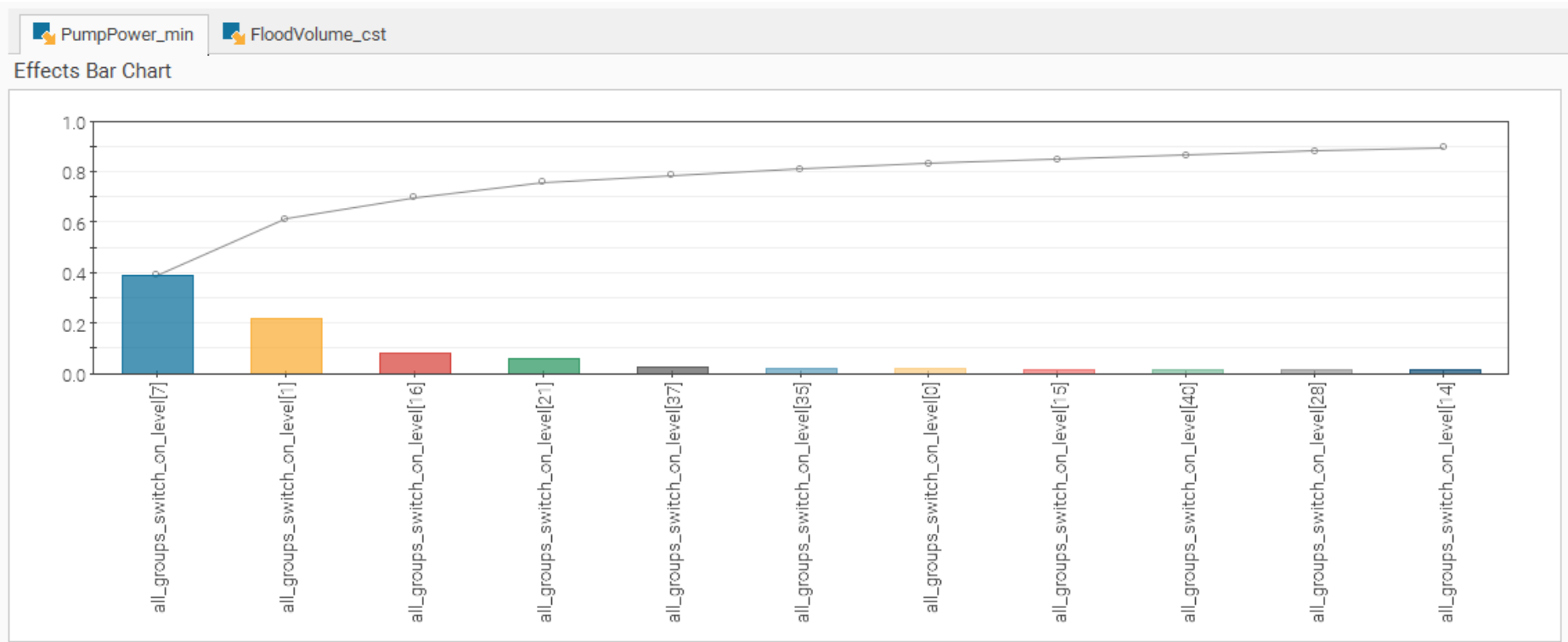

Figure 7-2 Sensitivity analysis for pump power

A final recommendation for any future research regards the optimisation algorithm deployment would be on the deployment if the NSGA-II solver. The research has concluded that this solver may have been constrained within the boundary conditions it was configured with and would have interest in seeing the NSGA-II solver having a wider (global) search of the design space, however, this would have required additional time to have been available to recalibrate the boundaries in which it operated.

### *7.4.3 The Objective*

When this research project began, the author was fresh out of completing a power engineering bachelor's degree and was focussed on the reduction of electrical energy within a wastewater catchment. Which, in the opinion of the author has been completed with great success and has contributed novel outcomes to the literature. However, the research project has been a journey in which the author has also learnt a great deal about, not only wastewater catchments and their pumping systems but also, the receiving treatment works that these systems culminate in and deposit their flows to. It is the authors knowledge that there are huge energy efficiencies to be yielded from providing a more stable flow into a sewage treatment works, rather than oscillatory flows that can come from wastewater catchment dynamics.

For example, in periods of very high flow and where the wastewater is of a particularly high-water content, this water is likely to short-circuit the primary settlement tanks and make its way through into the second stage treatment zone, where the aeration occurs. Aeration is an extremely energy intensive process and accounts for approximately 70% of the total wastewater treatment energy bill. There are considerable savings to be gained from smoothing the flows to the receiving works, as this will reduce the amount of water content that gets passed onto the aeration plant eliminating inefficient use of energy being used to aerate high water content, when the desire and application is to aerate the solid matter.

The author recommends that future research projects seriously consider using a flow balance objective as the target for exploration, as it is believed energy reduction will be a positive and measurable by-product of this approach.

## **7.5 Summary**

In closing; the first objective was met through a critical analysis of a SCADA upgrade within a UK water utility. The second objective involved using clustering techniques to identify the Bordon

wastewater catchment. The third objective was accomplished through physical surveys of pumping stations and modifying the hydraulic model with real-world data. The fourth objective was fulfilled by deploying the modeFRONTIER software package to reduce electrical energy consumption.

The conclusions of the research highlight the importance of aligning the SCADA infrastructure to a singular product and platform for optimal integration and scalability. The research emphasises the need for suitable training and engagement with operators and maintainers when implementing new operational technologies. It suggests avoiding the use of black-box systems and instead utilising existing control assets to ensure acceptance and maintainability. The research also emphasises the significance of considering human factors and addressing resistance to change in any major operational technology change.

The research concludes that the selection of the Bordon wastewater catchment was successfully achieved using clustering algorithms. It estimates the costs associated with upgrading pumping stations and highlights the need for investment to calibrate hydraulic models with real-world data. The research successfully deployed optimisation algorithms within a wastewater hydraulic model to reduce electrical energy consumption while maintaining a tolerable virtual risk level, although suggests that for real world applications this risk tolerance should be reduced.

The contribution to knowledge includes insights into control room acceptance, the use of clustering tools for asset upgrade decisions, validation of hydraulic models with real-world data, and the configuration of models for more accurate power output calculations. The research also presents a new control framework for optimal operating strategies in wastewater catchments.

The limitations of the research include limited processing power and license time for computational resources. Suggestions for future research include exploring alternative software and hardware options to overcome these limitations.

In conclusion, this research successfully achieved its objectives, providing valuable insights into SCADA upgrades, catchment selection, model validation, and wastewater catchment optimisation. The findings contribute to knowledge in various areas and offer recommendations for future work.

## References

1. Jadon, R.S. and U. Datta. *Modified ant colony optimization algorithm with uniform mutation using self-adaptive approach for travelling salesman problem*. in *2013 Fourth International Conference on Computing, Communications and Networking Technologies (ICCCNT)*. 2013.
2. Ganidi, N. and B. Holden, *Real Time Control of Water Distribution Systems Using a Multi-criteria Decision-support Tool for Optimal Water Network Management – A Case Study*. *Procedia Engineering*, 2014. **89**: p. 495-501.
3. Jensen Water Resources. *Minimum Storage Volume – Wet Wells*. Minimum Storage Volume – Wet Wells 2017 [cited 2020 15th May]; Available from: <https://www.jensenprecast.com/water-resources/pump-station-wet-wells-minimum-storage-volume/>.
4. Longo, S., et al., *Monitoring and diagnosis of energy consumption in wastewater treatment plants. A state of the art and proposals for improvement*. *Applied Energy*, 2016. **179**: p. 1251-1268.
5. Jones, M., *Demand side management: opportunities in water and sewage treatment*. *IEEE Power Engineering Review*, 1991. **11**(11): p. 8-9.
6. Berry, A., *Thames Water Energy Consumption*, A. Gray, Editor. 2018.
7. Gray, A.D., et al. *Optimising the use of electrical energy within the waste water industry through improved utilization of process control and automation*. in *2015 50th International Universities Power Engineering Conference (UPEC)*. 2015.
8. Gray, A.D., et al. *Exploiting Granular Electrical Energy Data and the Challenges a Utility Company Faces with an Ageing Asset Base*. in *Power Engineering Conference (UPEC), 2017 52nd International Universities*. 2017.
9. Hill, N.K., E. Jones, L. MacCarthy, J. Bonifazi E. Hinton, S. Walker, C. Harris, B., *2019 Government greenhouse gas conversion factors for company reporting*. 2019: Department for Business, Energy & Industrial Strategy. p. 26.
10. Thames Water. *Environment, Social and Governance Statement 2019*. 2019 [cited 2019 13th May]; Available from: <https://www.thameswater.co.uk/media-library/home/about-us/responsibility/sustainability/esg-2019.pdf>.
11. Velasquez-Orta, S.B., et al., *Retrofitting options for wastewater networks to achieve climate change reduction targets*. *Applied Energy*, 2018. **218**: p. 430-441.
12. HM Government, *Net Zero Strategy: Build Back Greener*, HM Government, Editor. 2021, HH Associates Ltd. on behalf of the Controller of Her Majesty's Stationery Office: Online.
13. Hinson, S., *Energy policy: an overview*, C. Library, Editor. 2020, UK Government: Commons Library. p. 26.
14. Thames Water, *Annual Report and Financial Statements 2021/22*. 2022: Online. p. 118.
15. Sonet, N.H., et al. *Prospect of Demand Side Management in Bangladesh: A Survey on Residential Application*. in *2020 11th International Conference on Electrical and Computer Engineering (ICECE)*. 2020.
16. Keles, C., B.B. Alagoz, and A. Kaygusuz. *A note on demand side load management by maximum power limited load shedding algorithm for smart grids*. in *2015 3rd International Istanbul Smart Grid Congress and Fair (ICSG)*. 2015.

17. Riaz, M.H., et al. *Demand side management using different energy conservation techniques*. in *2017 International Multi-topic Conference (INMIC)*. 2017.
18. Hoarcă, I.C., N. Bizon, and F.M. Enescu. *The design of the graphical interface for the SCADA system on an industrial platform*. in *2020 12th International Conference on Electronics, Computers and Artificial Intelligence (ECAI)*. 2020.
19. Dubuisson, F., et al., *Control of Hybrid Wind–Diesel Standalone Microgrid for Water Treatment System Application*. *IEEE Trans. on Ind. Appl.*, 2019. **55**(6): p. 6499-6507.
20. Rohmingtluanga, C., S. Datta, and N. Sinha. *Study of SCADA based Existing Water Treatment Plant-GAWSS Phase-I in Mizoram, India*. in *2021 IEEE International Power and Renewable Energy Conference (IPRECON)*. 2021.
21. Rojas, G.A., et al., *Supervisory System for Fault Detection and Diagnosis in Drinking Water Treatment Plants Using Fuzzy Engine*. *IEEE Latin America Transactions*, 2017. **15**(11): p. 2071-2076.
22. Desmurget, M. and S. Grafton, *Feedback or feedforward control: End of a dichotomy*. *Feedback or feedforward control: End of a dichotomy*. In S. H. Johnson-Frey (Ed.), *Taking action: Cognitive neuroscience perspectives on intentional acts*, 2003: p. 289-338.
23. Haugen, F., *Basic Dynamics and Control*. 2009, Skien, Norway: TechTeach. 103.
24. Borup, M., et al. *Updating distributed hydrodynamic urban drainage models*. in *13th International Conference on Urban Drainage*.
25. LightSource BP. *Queen Elizabeth II Reservoir Solar Project*. 2016 [cited 2022 17th June 2022]; Available from: <https://www.lightsourcebp.com/uk/projects/queen-elizabeth-ii-reservoir-solar-project/>.
26. Lafratta, M., et al., *Demand-Driven Biogas Production from Anaerobic Digestion of Sewage Sludge: Application in Demonstration Scale*. *Waste and Biomass Valorization*, 2021. **12**.
27. Lafratta, M., et al., *Economic and Carbon Costs of Electricity Balancing Services: The Need for Secure Flexible Low-Carbon Generation*. *Energies*, 2021. **14**: p. 5123.
28. Thames Water. *Climate Change and Carbon Footprint*. 2014 [1st February 2015]; Available from: [www.thameswater.co.uk/cr/Climatechange/Mitigatingclimatechange/Managingourcarbonfootprint/index.html](http://www.thameswater.co.uk/cr/Climatechange/Mitigatingclimatechange/Managingourcarbonfootprint/index.html).
29. Schütze, M., et al., *Real time control of urban wastewater systems—where do we stand today?* *Journal of Hydrology*, 2004. **299**(3–4): p. 335-348.
30. Osborne, M. *ANN\_2E\_Opportunities and Benefits for Application of ANN Models*. *THE USE OF ARTIFICIAL NEURAL NETWORKS (ANNS) IN MODELLING SEWERAGE SYSTEMS FOR MANAGEMENT IN REAL TIME*, 2014. **2E**.
31. Matlis, J., *Virtual Machines*. *Computerworld*, 2006. **40**(17): p. 38.
32. Zhang, Y. *Artificial Intelligence Governance Capability Association Model based on Closed-loop Control Theory*. in *2020 IEEE 9th Joint International Information Technology and Artificial Intelligence Conference (ITAIC)*. 2020.

33. Nair, J.P. and M.S. Vijaya. *Predictive Models for River Water Quality using Machine Learning and Big Data Techniques - A Survey*. in *2021 International Conference on Artificial Intelligence and Smart Systems (ICAIS)*. 2021.
34. Ostojin, S., S.R. Mounce, and J.B. Boxall, *An artificial intelligence approach for optimizing pumping in sewer systems*. *Journal of Hydroinformatics*, 2011. **13**: p. 12.
35. Arslan, A. and M. Kaya, *Determination of fuzzy logic membership functions using genetic algorithms*. *Fuzzy Sets and Systems*, 2001. **118**(2): p. 297-306.
36. Kissi, M., et al., *Determination of fuzzy logic membership functions using genetic algorithms: application to structure-odor modeling*. *Journal of Molecular Modeling*, 2004. **10**(5): p. 335-341.
37. Said, Y.H., *13 - On Genetic Algorithms and their Applications*, in *Handbook of Statistics*, C.R. Rao, E.J. Wegman, and J.L. Solka, Editors. 2005, Elsevier. p. 359-390.
38. Goldberg, D.E. and J.H. Holland, *Genetic Algorithms and Machine Learning*. *Machine Learning*, 1988. **3**(2): p. 95-99.
39. Dorigo, M. and U. Schnepf, *Genetics-based machine learning and behavior-based robotics: a new synthesis*. *IEEE Transactions on Systems, Man, and Cybernetics*, 1993. **23**(1): p. 141-154.
40. Karr, C.L. *Design of an Adaptive Fuzzy Logic Controller Using a Genetic Algorithm*. in *ICGA*. 1991.
41. Ostojin, S., et al., *Field validation of an artificial intelligence based sewer pump control system*, in *9th International Conference on Urban Drainage Modelling*. 2012, Pennine Water Group, Dept of Civil and Structural Engineering, University of Sheffield: Belgrade.
42. Ostojin, S., et al., *Autonomous fuzzy logic control of pumping in sewer systems*, in *ICA2013*, D.o.C.a.S.E. Pennine Water Group, University of Sheffield Editor. 2013: Peterborough.
43. Smith, E. *ANN\_2A\_Crossness Pilot Study*. THE USE OF ARTIFICIAL NEURAL NETWORKS (ANNS) IN MODELLING SEWERAGE SYSTEMS FOR MANAGEMENT IN REAL TIME, 2014. **2A**.
44. Bennett, J. and M. Osborne *ANN\_2B\_Model\_test\_Portsmouth\_Pilot\_study\_Vol\_2B*. THE USE OF ARTIFICIAL NEURAL NETWORKS (ANNS) IN MODELLING SEWERAGE SYSTEMS FOR MANAGEMENT IN REAL TIME, 2014. **2B**.
45. Hill, J. and R. Allitt *ANN\_2C\_Dorchester Pilot Study Vol 2C*. THE USE OF ARTIFICIAL NEURAL NETWORKS (ANNS) IN MODELLING SEWERAGE SYSTEMS FOR MANAGEMENT IN REAL TIME, 2014. **2C**.
46. Duncan, A., et al. *ANN\_2D\_Model\_development\_Vol\_2D*. THE USE OF ARTIFICIAL NEURAL NETWORKS (ANNS) IN MODELLING SEWERAGE SYSTEMS FOR MANAGEMENT IN REAL TIME, 2014. **2D**.
47. Lin, F., X. Chen, and H. Yao, *Evaluating the Use of Nash-Sutcliffe Efficiency Coefficient in Goodness-of-Fit Measures for Daily Runoff Simulation with SWAT*. *Journal of Hydrologic Engineering*, 2017. **22**(11): p. 05017023.
48. Tynemarch Systems Engineering Ltd. *MISER - Ensuring Optimal Wafer Management*. 2014 [cited 2022 20th June 2022]; Available from: <https://www.environmental-expert.com/products/miser-ensuring-optimal-wafer-management-65672>.

49. US Environmental Protection Agency. *Application for Modeling Drinking Water Distribution Systems*. 2022 [cited 2022 20th June 2022]; Available from: <https://www.epa.gov/water-research/epanet>.
50. Rossman, L.A., *EPANET 2: users manual*. 2000.
51. Shao, Y., et al., *Real-Time Water Distribution System Hydraulic Modeling Using Prior Demand Information by Formal Bayesian Approach*. *Journal of water resources planning and management*, 2019. **145**(12): p. 10.1061/(asce)wr.1943-5452.0001137.
52. Lopez-Ibanez, M., *Operational Optimisation of Water Distribution Networks*. 2009, Napier: Edinburgh.
53. Apte, S., M. Kshirsagar, and K. Khare. *Optimization of Storm Water Drainage Network using Ant Colony System*. in *2018 IEEE Punecon*. 2018.
54. Juang, C., et al., *Ant Colony Optimization Algorithm for Fuzzy Controller Design and Its FPGA Implementation*. *IEEE Transactions on Industrial Electronics*, 2008. **55**(3): p. 1453-1462.
55. Olivas, E.L., et al. *Ant colony optimization for membership function design for a water tank fuzzy logic controller*. in *2013 IEEE Workshop on Hybrid Intelligent Models and Applications (HIMA)*. 2013.
56. Juang, C.F. and L. Chun-Ming. *Reinforcement fuzzy control using Ant Colony Optimization*. in *2008 IEEE International Conference on Systems, Man and Cybernetics*. 2008.
57. Tong, L., G. Han, and J. Qiao. *Design of water distribution network via ant colony optimization*. in *2011 2nd International Conference on Intelligent Control and Information Processing*. 2011.
58. Niendorf, M., P.T. Kabamba, and A.R. Girard, *Stability of Solutions to Classes of Traveling Salesman Problems*. *IEEE Transactions on Cybernetics*, 2016. **46**(4): p. 973-985.
59. Pont-Lezica, I., *Abstraction Efficiency in Inter-Stage Pumping*, A.D. Gray, Editor. 2014.
60. Nidhra, S. and J. Dondeti, *Black box and white box testing techniques-a literature review*. *International Journal of Embedded Systems and Applications (IJESA)*, 2012. **2**(2): p. 29-50.
61. Robertson, M. *Advanced Thermodynamic Performance Measurements for pumps and pump systems*. 2013.
62. Sun, Q. *Research and design of the computer-aided selection system of the circulation pump based on the performance curve*. in *2012 3rd International Conference on System Science, Engineering Design and Manufacturing Informatization*. 2012.
63. Keiser, B., *Know Your Pump & System Curves*, A.F. Technology, Editor. 2021: [www.aft.com](http://www.aft.com).
64. Ramanathan, R. *The IEC 61131-3 programming languages features for industrial control systems*. in *2014 World Automation Congress (WAC)*. 2014.
65. Rockwell Automation. *ISaGRAF Technology - Tech Data*. 2022 [cited 2022 22nd June 2022]; Technical info on ISaGRAF]. Available from: [https://www.rockwellautomation.com/en-gb/support/documentation/technical-data/isagraf\\_20190326-0743.html#gate-c7a1d049-9785-4a26-b4b3-385c16d9aa90](https://www.rockwellautomation.com/en-gb/support/documentation/technical-data/isagraf_20190326-0743.html#gate-c7a1d049-9785-4a26-b4b3-385c16d9aa90).

66. National Grid. *Short term operating reserve (STOR)*. 2022 [cited 2022 22nd June 2022]; Available from: <https://www.nationalgrideso.com/industry-information/balancing-services/reserve-services/short-term-operating-reserve>.
67. National Grid. *Short term operating reserve (STOR)*. 2016 [cited 2016 2nd April 2016]; Available from: <https://www.nationalgrideso.com/industry-information/balancing-services/reserve-services/short-term-operating-reserve>.
68. Duffield, M. and Claverton Energy Research Group. *Commercial Opportunities for Back-Up Generation (including diesel generators) and Load Reduction via National Grid, the National Electricity Transmission System Operator (NETSO) for England, Scotland, Wales and Offshore*. . 2009 [cited 2022 22nd June 2022]; Available from: <https://claverton-energy.com/commercial-opportunities-for-back-up-generation-and-load-reduction-via-national-grid-the-national-electricity-transmission-system-operator-netso-for-england-scotland-wales-and-offshore.html>.
69. E-on. *Transmission Network Use of System Recovering the cost of running and maintaining the National Grid*. 2022 [cited 2022 22nd June 2022]; Article]. Available from: <https://www.eonenergy.com/for-your-business/large-energy-users/Understand-Energy/~media/PDFs/For-your-business/Large-Energy-Users/3rd%20Party%20Charges/TNUoS%20charge.pdf>.
70. National Grid. *What are electricity Triads?* 2018 [cited 2022 22nd June 2022]; Available from: <https://www.nationalgrideso.com/sites/eso/files/documents/Guidance%20What%20are%20Triads.pdf>.
71. E-on. *Should Triads still concern industrial and commercial energy users?* . 2022 [cited 2022 22nd June 2022]; Article]. Available from: <https://www.eonenergy.com/business/news-and-insights/your-business/energy-triads.html>.
72. Bajic, B., et al., *Industry 4.0 Implementation Challenges and Opportunities: A Managerial Perspective*. IEEE Systems Journal, 2021. **15**(1): p. 546-559.
73. Institute of Entrepreneurship Development. *The 4 Industrial Revolutions*. 2019 [cited 2022 22nd June 2022]; Available from: <https://ied.eu/project-updates/the-4-industrial-revolutions/>.
74. Johnson, D.G. and M. Noorman. *Principles for the future development of artificial agents*. in *2014 IEEE International Symposium on Ethics in Science, Technology and Engineering*. 2014.
75. Thames Water. *Lots Road (Chelsea) Storm Sewage Pumping Station*. circa 1900 [cited 2022 22nd June 2022]; Available from: <https://archive.thameswater.co.uk/archive/lantern-slides/1153377-lots-road-pumping-station?>
76. British Listed Buildings. *London County Council pumping station*. 2007 [cited 2022 June 22nd 2022]; Lots Road SPS]. Available from: <https://britishlistedbuildings.co.uk/101392309-london-county-council-pumping-station-chelsea-riverside-ward#.YrMbvezMJyE>.
77. Gibbons, J.H., *Computerized Manufacturing Automation: Employment, Education, and the Work place*. 1984, Washington, D. C.: Congress, Office of Technology Assessment.
78. Steusloff, H. *Humans Are Back in the Loop! Would Production Process Related Ethics Support the Design, Operating, and Standardization of Safe, Secure, and Efficient Human-Machine Collaboration?* in *2016 IEEE 4th International Conference on Future Internet of Things and Cloud Workshops (FiCloudW)*. 2016.



79. Xu, X., et al., *Industry 4.0 and Industry 5.0—Inception, conception and perception*. Journal of Manufacturing Systems, 2021. **61**: p. 530-535.
80. Breque, M., L. De Nul, and A. Petridis, *Industry 5.0: towards a sustainable, human-centric and resilient European industry*. Luxembourg, LU: European Commission, Directorate-General for Research and Innovation, 2021.
81. Ofwat. *INTRODUCTORY NOTE CRITIQUE OF OFWAT'S TOTEX MODELLING APPROACH*. 2014 [cited 2015 3rd March 2015]; Business Plan Resubmission June 2014]. Available from: [http://www.ofwat.gov.uk/pricereview/pr14/res\\_stk201407costassessdvw.pdf](http://www.ofwat.gov.uk/pricereview/pr14/res_stk201407costassessdvw.pdf).
82. Bin, M., N. Lubiao, and Y. Shijin. *Waste water discharge optimization modeling using neural network and genetic algorithm*. in *2015 4th International Conference on Computer Science and Network Technology (ICCSNT)*. 2015.
83. Kamilaris, A., et al., *A literature survey on measuring energy usage for miscellaneous electric loads in offices and commercial buildings*. Renewable and Sustainable Energy Reviews, 2014. **34**: p. 536-550.
84. Krishnanand, K.R., et al. *Electrical submetering with repurposable applications for the built environment*. in *IECON 2016 - 42nd Annual Conference of the IEEE Industrial Electronics Society*. 2016.
85. Zhang, Z., et al., *Modeling and optimization of a wastewater pumping system with data-mining methods*. Applied Energy, 2016. **164**: p. 303 - 311.
86. Haven Power. *Haven Power signs £520m deal to provide Thames Water with 100% renewable energy*. 2015 [cited 2017 25th May]; Available from: <http://www.havenpower.com/news/haven-power-signs-520m-deal-to-provide-thames-water-with-100-renewable-energy/2272>.
87. Thames Water, *Extract from electrical line diagram. An Example of an HV/LV Bus Coupling* 2015, Thames Water,: Internal Database. p. Extract from electrical line diagram. An Example of an HV/LV Bus Coupling
88. The Water Services Regulation Authority, *PR19 Draft Determinations - UK Government priorities and our 2019 price review draft determinations*. 2019. p. 29.
89. The Water Services Regulation Authority, *Future water and sewerage charges 2010-15: Final Determinations* The Water Services Regulation Authority, Editor. 2009, The Water Services Regulation Authority, .
90. UK Government, *The Measuring Instruments (ActiveElectrical Energy Meters) Regulations 2006, in 1679*. 2006: Legislation.gov.uk.
91. UK Government. *MID approved gas and electricity meters*. 2014 [cited 2017 25th May]; Available from: <https://www.gov.uk/guidance/mid-approved-gas-and-electricity-meters>.
92. Socomec Group, *DIRIS A40/A41 - Operating instructions*, Socomec, Editor. 2013, Socomec SA. p. 84.
93. Lindmark, J. and M. Håkansson. *Smart Grid using 1<sup>st</sup> generation AMR meters &#x2014; An operational view*. in *22nd International Conference and Exhibition on Electricity Distribution (CIRED 2013)*. 2013.

94. Williams, J.T., *The Purdue Enterprise Reference Architecture and Methodology (PERA)*. 1992, Institute for Interdisciplinary Engineering Studies: Purdue University. p. 48.
95. ZScaler. *What is the Purdue model for ICS security?* 2022 [cited 2022 14th June 2022]; Available from: <https://www.zscaler.com/resources/security-terms-glossary/what-is-purdue-model-ics-security>.
96. Greenfield, D. *Is the Purdue Model Still Relevant?* 2022 [cited 2022 14th June 2022]; Available from: <https://www.automationworld.com/factory/iiot/article/21132891/is-the-purdue-model-still-relevant>.
97. Gray, A.D.L., et al., *A Standardised Modular Approach for Site SCADA Applications within a Water Utility*. IEEE Access, 2017. **PP**(99): p. 1-1.
98. Thames Water. *About Us - Asset Optimisation*. 2014 [1st February 2015]; Available from: [www.thameswater.co.uk/about-us/10098.htm](http://www.thameswater.co.uk/about-us/10098.htm)
99. Zack, M.H., *Managing codified knowledge*. Sloan management review, 1999. **40**(4): p. 45-58.
100. Kulkarni, P. and T. Farnham, *Smart City Wireless Connectivity Considerations and Cost Analysis: Lessons Learnt From Smart Water Case Studies*. IEEE Access, 2016. **4**: p. 660-672.
101. Jones, M. *Digging Deeper: Big Data Dilemma*. 2016 [cited 2016 10th January 2016]; Available from: <http://www.online.co.uk/features/big-data-dilemma#.VpJQiFk2W7I>.
102. Grilo, A.M., et al., *An Integrated WSN and SCADA System for Monitoring a Critical Infrastructure*. Industrial Informatics, IEEE Transactions on, 2014. **10**(3): p. 1755-1764.
103. May, P.J. and C. Koski, *Addressing Public Risks: Extreme Events and Critical Infrastructures*. Review of Policy Research, 2013. **30**(2): p. 139-159.
104. See, C.H., et al. *A Zigbee based wireless sensor network for sewerage monitoring*. in *Microwave Conference, 2009. APMC 2009. Asia Pacific*. 2009.
105. Thames Water, *Annual Report and Financial Statements 2014/15*. 2015: Online. p. 173.
106. Gaj, P., J. Jasperneite, and M. Felser, *Computer Communication Within Industrial Distributed Environment - A Survey*. Industrial Informatics, IEEE Transactions on, 2013. **9**(1): p. 182-189.
107. Kyung Chang, L., L. Suk, and L. Man Hyung, *QoS-based remote control of networked control systems via Profibus token passing protocol*. Industrial Informatics, IEEE Transactions on, 2005. **1**(3): p. 183-191.
108. Shoshani, G., S. Mitschke, and S. Stephan. *Industrial Fieldbus technology and Fieldbus cable overview - Cable standards and electrical qualifications*. in *Petroleum and Chemical Industry Conference (PCIC), 2010 Record of Conference Papers Industry Applications Society 57th Annual*. 2010.
109. Iconics, *GENESIS 32 - Product Brief for GENESIS32 V9.4*, I. Inc, Editor. 2015, Iconics Inc.
110. Gaj, P., et al., *Virtualization as a Way to Distribute PC-Based Functionalities*. Industrial Informatics, IEEE Transactions on, 2015. **11**(3): p. 763-770.
111. Veeam, *Veeam Backup Enterprise Manager*, in *User Guide*. 2016, Veeam Software. p. 115.

112. Cheminod, M., L. Durante, and A. Valenzano, *Review of Security Issues in Industrial Networks*. Industrial Informatics, IEEE Transactions on, 2013. **9**(1): p. 277-293.
113. Badawy, M.A., N.A. El-Fishawy, and O. Elshakankiry. *Using Patch Management Tools to Enhance the Signature Customization for IDS Based on Vulnerability Scanner*. in *Information Technology: New Generations (ITNG), 2014 11th International Conference on*. 2014.
114. Thames Water, *AM-DES-SCADA-F24-SEC5*, in *Asset Management Asset Standard Section 5 of 13*. 2014, Thames Water: Internal.
115. Chuang, C. and H. Chou, *Design Development and Implementation of the Human-System Interface for Lungmen Nuclear Project*. IEEE Transactions on Nuclear Science, 2008. **55**(5): p. 2654-2661.
116. Nov, O. and C. Ye. *Personality and Technology Acceptance: Personal Innovativeness in IT, Openness and Resistance to Change*. in *Hawaii International Conference on System Sciences, Proceedings of the 41st Annual*. 2008.
117. Tang, X. and P. Zhu, *Hierarchical Clustering Problems and Analysis of Fuzzy Proximity Relation on Granular Space*. IEEE Transactions on Fuzzy Systems, 2013. **21**(5): p. 814-824.
118. Zhou, S., Z. Xu, and F. Liu, *Method for Determining the Optimal Number of Clusters Based on Agglomerative Hierarchical Clustering*. IEEE Transactions on Neural Networks and Learning Systems, 2017. **28**(12): p. 3007-3017.
119. Wu, B. and B.M. Wilamowski, *A Fast Density and Grid Based Clustering Method for Data With Arbitrary Shapes and Noise*. IEEE Transactions on Industrial Informatics, 2017. **13**(4): p. 1620-1628.
120. Wang, X. and D. Huang, *A Novel Density-Based Clustering Framework by Using Level Set Method*. IEEE Transactions on Knowledge and Data Engineering, 2009. **21**(11): p. 1515-1531.
121. Wang, J., et al., *From Partition-Based Clustering to Density-Based Clustering: Fast Find Clusters With Diverse Shapes and Densities in Spatial Databases*. IEEE Access, 2018. **6**: p. 1718-1729.
122. Hua, M., et al., *Continuous K-Means Monitoring with Low Reporting Cost in Sensor Networks*. IEEE Transactions on Knowledge and Data Engineering, 2009. **21**(12): p. 1679-1691.
123. Xu, Y., et al., *Efficient k-Means++ Approximation with MapReduce*. IEEE Transactions on Parallel and Distributed Systems, 2014. **25**(12): p. 3135-3144.
124. Ilham, A., et al. *Tackling Initial Centroid of K-Means with Distance Part (DP-KMeans)*. in *2018 International Symposium on Advanced Intelligent Informatics (SAIN)*. 2018.
125. Xu, T., et al., *Hierarchical K-means Method for Clustering Large-Scale Advanced Metering Infrastructure Data*. IEEE Transactions on Power Delivery, 2017. **32**(2): p. 609-616.
126. The MathWorks, I. *K-Means Clustering*. 2019 [28th Dec 2019]; Available from: <https://uk.mathworks.com/help/stats/kmeans.html>.
127. Arthur, D. and S. Vassilvitskii. *K-means++: The Advantages of Careful Seeding*. in *SODA '07: Proceedings of the Eighteenth Annual ACM-SIAM Symposium on Discrete Algorithms*. 2007.
128. Li, P.-H., S. Pye, and I. Keppo, *Using clustering algorithms to characterise uncertain long-term decarbonisation pathways*. Applied Energy, 2020. **268**: p. 114947.

129. Kaufman, L.R., P. J. , *Finding Groups in Data: An Introduction to Cluster Analysis*. 1990, Hoboken, NJ: John Wiley & Sons, Inc.
130. The MathWorks, I. *Silhouette Plot*. 1994-2019 [cited 2019 28th Dec 2019]; Available from: <https://uk.mathworks.com/help/stats/silhouette.html>.
131. Brinkhoff, T. *Bordon Map and Population Overlay*. 2020 [cited 2022 24th June 2022]; Available from: [https://www.citypopulation.de/en/uk/southeastengland/hampshire/E35000879\\_\\_bordon/](https://www.citypopulation.de/en/uk/southeastengland/hampshire/E35000879__bordon/).
132. Walters, D., *Pumping Station Architecture*. 2018, Thames Water: Internally.
133. Xylem Inc, *Technical Product Information (TPI)*. 2017, Xylem Inc,: Online.
134. Karassik, I., et al., *Pump Handbook - Fourth Edition*. 2008: McGraw-Hill Education - Europe. 1824.
135. Wei, N., et al. *Modeling and Optimization of Pumps Scheduling Considering the Time-of-use Electricity Tariff*. in *2020 39th Chinese Control Conference (CCC)*. 2020.
136. UK Power. *Compare energy prices per kWh*. 2020 [cited 2020 2nd Jan 2020]; Available from: [https://www.ukpower.co.uk/home\\_energy/tariffs-per-unit-kwh](https://www.ukpower.co.uk/home_energy/tariffs-per-unit-kwh).
137. Du, W., et al., *High-Dimensional Robust Multi-Objective Optimization for Order Scheduling: A Decision Variable Classification Approach*. *IEEE Transactions on Industrial Informatics*, 2019. **15**(1): p. 293-304.
138. Bengio, S. and Y. Bengio, *Taking on the curse of dimensionality in joint distributions using neural networks*. *IEEE Transactions on Neural Networks*, 2000. **11**(3): p. 550-557.
139. Liu, Z., et al., *Intrusion Detection Based on Parallel Intelligent Optimization Feature Extraction and Distributed Fuzzy Clustering in WSNs*. *IEEE Access*, 2018. **6**: p. 72201-72211.
140. Gao, S., et al., *Multi-Strategy Adaptive Cuckoo Search Algorithm*. *IEEE Access*, 2019. **7**: p. 137642-137655.
141. Li, B., *Efficiency Optimization for Communication Service Based on QoS Technology*. *IEEE Access*, 2019. **7**: p. 48838-48848.
142. Jia, H., et al., *Multi-Strategy Emperor Penguin Optimizer for RGB Histogram-Based Color Satellite Image Segmentation Using Masi Entropy*. *IEEE Access*, 2019. **7**: p. 134448-134474.
143. Takahama, T. and S. Sakai. *Solving Constrained Optimization Problems by the  $\epsilon$  Constrained Particle Swarm Optimizer with Adaptive Velocity Limit Control*. in *2006 IEEE Conference on Cybernetics and Intelligent Systems*. 2006.
144. Roberge, V. and M. Tarbouchi. *Hybrid Method Based on Metaheuristics and Interior Point for Optimal Power Flow*. in *2021 Fifth International Conference On Intelligent Computing in Data Sciences (ICDS)*. 2021.
145. Mugemanyi, S., et al., *Optimal Reactive Power Dispatch Using Chaotic Bat Algorithm*. *IEEE Access*, 2020. **8**: p. 65830-65867.
146. Grudin, N., *Reactive power optimization using successive quadratic programming method*. *IEEE Transactions on Power Systems*, 1998. **13**(4): p. 1219-1225.

147. Lamsali, H. *A mixed integer non-linear programming model for optimizing the collection methods of returned products*. in *2011 Ninth International Conference on ICT and Knowledge Engineering*. 2012.
148. Kuendee, P. and U. Janjarassuk. *A comparative study of mixed-integer linear programming and genetic algorithms for solving binary problems*. in *2018 5th International Conference on Industrial Engineering and Applications (ICIEA)*. 2018.
149. Zhang, S., H. Wang, and M. Huang. *Dominant gradient strategy based on pareto dominant and gradient method*. in *2016 Chinese Control and Decision Conference (CCDC)*. 2016.
150. Xu, H., M. Wang, and C.H. Lai. *Generalized Newton Method for Minimization of a Region-Based Active Contour Model*. in *2013 12th International Symposium on Distributed Computing and Applications to Business, Engineering & Science*. 2013.
151. Huang, Z.S. and W.L. Li. *Novel Multi-Strategy Enhanced Whale Optimization Algorithm*. in *2020 IEEE Eurasia Conference on IOT, Communication and Engineering (ECICE)*. 2020.
152. Tůmová, O., L. Kupka, and P. Netolický. *Design of Experiments approach and its application in the evaluation of experiments*. in *2018 International Conference on Diagnostics in Electrical Engineering (Dagnostika)*. 2018.
153. Junaid, M., W.H. Bangyal, and J. Ahmad. *A Novel Bat Algorithm using Sobol Sequence for the Initialization of Population*. in *2020 IEEE 23rd International Multitopic Conference (INMIC)*. 2020.
154. Antony, J., 6 - *Full Factorial Designs*, in *Design of Experiments for Engineers and Scientists (Second Edition)*, J. Antony, Editor. 2014, Elsevier: Oxford. p. 63-85.
155. Jamshidnezhad, M., 3 - *Experimental design in reservoir engineering*, in *Experimental Design in Petroleum Reservoir Studies*, M. Jamshidnezhad, Editor. 2015, Gulf Professional Publishing: Boston. p. 57-98.
156. Rahman, A.S., 6 - *Effects of nanofibers on properties of geopolymer composites*, in *Nanotechnology in Eco-efficient Construction (Second Edition)*, F. Pacheco-Torgal, et al., Editors. 2019, Woodhead Publishing. p. 123-140.
157. Pant, M., et al. *Particle Swarm Optimization Using Sobol Mutation*. in *2008 First International Conference on Emerging Trends in Engineering and Technology*. 2008.
158. Shang, Y., et al. *Optimization of a Consequent-Pole PMSM with a Sobol Sequence Based Multi-Objective Hybrid Optimization Algorithm*. in *2021 24th International Conference on Electrical Machines and Systems (ICEMS)*. 2021.
159. Yin, J., et al. *Application of Monte Carlo sampling and Latin Hypercube sampling methods in pumping schedule design during establishing surrogate model*. in *2011 International Symposium on Water Resource and Environmental Protection*. 2011.
160. Wan, Y., Z. Lu, and X. Yuan, *Latin hypercube sampling and updated Latin hypercube sampling method for reliability sensitivity and its variance analysis*. 2008. **30**: p. 927-934.
161. Hossain, F., E.N. Anagnostou, and A.C. Bagtzoglou, *On Latin Hypercube sampling for efficient uncertainty estimation of satellite rainfall observations in flood prediction*. *Computers & Geosciences*, 2006. **32**(6): p. 776-792.

162. Llopis-Albert, C., et al., *Optimal Reconfiguration of a Parallel Robot for Forward Singularities Avoidance in Rehabilitation Therapies. A Comparison via Different Optimization Methods*. MDPI - Sustainability, 2020. **12**.
163. Chen, Z., et al., *A Large-Signal Statistical Model and Yield Estimation of GaN HEMTs Based on Response Surface Methodology*. IEEE Microwave and Wireless Components Letters, 2016. **26**(9): p. 690-692.
164. Office of Gas and Electricity Markets, *Check if the energy price cap affects you*. 2022.
165. Yang, X. *Kalman Optimizer for Consistent Gradient Descent*. in *ICASSP 2021 - 2021 IEEE International Conference on Acoustics, Speech and Signal Processing (ICASSP)*. 2021.
166. Pazderin, A. and S. Yuferev. *Power flow calculation by combination of Newton-Raphson method and Newton's method in optimization*. in *2009 35th Annual Conference of IEEE Industrial Electronics*. 2009.
167. Badics, Z. and Z.J. Cendes, *A Newton-Raphson algorithm with adaptive accuracy control based on a block-preconditioned conjugate gradient technique*. IEEE Transactions on Magnetics, 2005. **41**(5): p. 1652-1655.
168. Wilson, P. and H.A. Mantooth, *Chapter 10 - Model-Based Optimization Techniques*, in *Model-Based Engineering for Complex Electronic Systems*, P. Wilson and H.A. Mantooth, Editors. 2013, Newnes: Oxford. p. 347-367.
169. Li, J., et al., *Parameter estimation algorithms for Hammerstein output error systems using Levenberg–Marquardt optimization method with varying interval measurements*. Journal of the Franklin Institute, 2017. **354**(1): p. 316-331.
170. Song, F., et al. *The optimization study of FBG Gaussian fitting peak-detection based on Levenberg-Marquardt algorithm*. in *2017 Chinese Automation Congress (CAC)*. 2017.
171. Le, D.-H., et al. *Parameter extraction and optimization using Levenberg-Marquardt algorithm*. in *2012 Fourth International Conference on Communications and Electronics (ICCE)*. 2012.
172. Yusoff, Y., M.S. Ngadiman, and A.M. Zain, *Overview of NSGA-II for Optimizing Machining Process Parameters*. Procedia Engineering, 2011. **15**: p. 3978-3983.
173. Deb, K., et al., *A fast and elitist multiobjective genetic algorithm: NSGA-II*. IEEE Transactions on Evolutionary Computation, 2002. **6**(2): p. 182-197.

**Optimisation of Water Companies Waste  
Pumping Asset Base with a Focus on Energy  
Reduction**

**Appendix 1 – Mat-Code Script used for K-Means  
Clustering**

**Alex Gray**

**2022**

*College of Engineering, Design and Physical  
Sciences Brunel University London*

# Contents

<b>List of Figures .....</b>	<b>Error! Bookmark not defined.</b>
<b>1 Mat-Code Script used for K-Means Clustering .....</b>	<b>180</b>
<b>2 KML output files for each cluster .....</b>	<b>186</b>
2.1 Cluster 1.....	186
2.2 Cluster 2.....	187
2.3 Cluster 3.....	188
2.4 Cluster 4.....	189
2.5 Cluster 5.....	190
2.6 Cluster 6.....	191
2.7 Cluster 7.....	192
2.8 Cluster 8.....	194
2.9 Cluster 9.....	196
2.10 Cluster 10.....	198
2.11 Cluster 11.....	199
2.12 Cluster 12.....	202
2.13 Cluster 13.....	203
2.14 Cluster 14.....	207
2.15 Cluster 15.....	208
2.16 Cluster 16.....	211
2.17 Cluster 17.....	213
2.18 Cluster 18.....	214
2.19 Cluster 19.....	215
2.20 Cluster 20.....	216



## Mat-Code Script used for K-Means Clustering

The following script was written by the author for the purpose of clustering the wastewater pumping station dataset. It was used to identify catchment clusters following an overlay with google earth .KML files.

```
% -----  
% KMeans Clustering for Optimised Pump Stations  
%% Load the data and convert to an array  
load('OptimisedPumpStations.mat')  
X = OptimisedPumpStations(:,4:5);  
X= table2array (X);  
  
%% Plot all data points to 'visualise' cluster numbers  
figure;  
plot(X(:,1),X(:,2), '.');  
title 'Optimised Pump Station All Data';  
xlabel 'Latitude';  
ylabel 'Longitude';  
  
% Study the first plot to see how many clusters 'appear'  
% Partition the data into n-number clusters by configuring the input  
% Determine intialization and execute script  
  
%clusters = str2double( inputdlg('Insert number of Clusters.') );  
clusters = 20; %hard coded cluster number  
init = str2double( inputdlg('Insert number of Initialisations.') );  
  
%% Run KMeans Script  
opts = statset('Display','final');  
[idx,C] = kmeans(X,clusters,'Distance','cityblock',...  
    'Replicates',init,'Options',opts);  
  
%% Plot Results and Condition the Graph  
colorstring = {[1 1 0]; [1 0 1]; [0 1 1]; [1 0 0]; [0 1 0]; ...  
    [0 0 1]; [1 1 1]; [0 0 0]; [0.9 0.1 0.2]; [0.8 0.1 0.3]; [0.7 0.2 0.2];...  
    [0.1 0.6 0.3]; [0.2 0.6 0.9]; [0.3 0.4 0.5]; [0.6 0.7 0.8]; [0.9 0.8  
0.7];...  
    [0.6 0.5 0.4]; [0.3 0.2 0.1]; [0.1 0.2 0.3]; [0.2 0.4 0.6]};  
figure;  
plot(X(idx==1,1),X(idx==1,2), '.', 'Color', colorstring{1}', 'MarkerSize',12)  
hold on  
plot(X(idx==2,1),X(idx==2,2), '.', 'Color', colorstring{2}', 'MarkerSize',12)  
plot(X(idx==3,1),X(idx==3,2), '.', 'Color', colorstring{3}', 'MarkerSize',12)  
plot(X(idx==4,1),X(idx==4,2), '.', 'Color', colorstring{4}', 'MarkerSize',12)  
plot(X(idx==5,1),X(idx==5,2), '.', 'Color', colorstring{5}', 'MarkerSize',12)  
plot(X(idx==6,1),X(idx==6,2), '.', 'Color', colorstring{6}', 'MarkerSize',12)  
plot(X(idx==7,1),X(idx==7,2), '.', 'Color', colorstring{7}', 'MarkerSize',12)  
plot(X(idx==8,1),X(idx==8,2), '.', 'Color', colorstring{8}', 'MarkerSize',12)  
plot(X(idx==9,1),X(idx==9,2), '.', 'Color', colorstring{9}', 'MarkerSize',12)  
plot(X(idx==10,1),X(idx==10,2), '.', 'Color', colorstring{10}', 'MarkerSize',12)  
plot(X(idx==11,1),X(idx==11,2), '.', 'Color', colorstring{11}', 'MarkerSize',12)  
plot(X(idx==12,1),X(idx==12,2), '.', 'Color', colorstring{12}', 'MarkerSize',12)
```

```

plot(X(idx==13,1),X(idx==13,2),'.','Color',colorstring{13}','MarkerSize',12)
plot(X(idx==14,1),X(idx==14,2),'.','Color',colorstring{14}','MarkerSize',12)
plot(X(idx==15,1),X(idx==15,2),'.','Color',colorstring{15}','MarkerSize',12)
plot(X(idx==16,1),X(idx==16,2),'.','Color',colorstring{16}','MarkerSize',12)
plot(X(idx==17,1),X(idx==17,2),'.','Color',colorstring{17}','MarkerSize',12)
plot(X(idx==18,1),X(idx==18,2),'.','Color',colorstring{18}','MarkerSize',12)
plot(X(idx==19,1),X(idx==19,2),'.','Color',colorstring{19}','MarkerSize',12)
plot(X(idx==20,1),X(idx==20,2),'.','Color',colorstring{20}','MarkerSize',12)

```

```

plot(C(:,1),C(:,2),'kx',...
     'MarkerSize',10,'LineWidth',2)
legend('Cluster 1','Cluster 2','Cluster 3','Cluster 4','Cluster 5'...
      , 'Cluster 6','Cluster 7','Cluster 8','Cluster 9','Cluster 10'...
      , 'Cluster 11','Cluster 12','Cluster 13','Cluster 14','Cluster 15'...
      , 'Cluster 16','Cluster 17','Cluster 18','Cluster 19','Cluster 20'...
      , 'Centroids','Location','NE')
title 'Optimised Pump Station K-Means'
set(gcf, 'color', [0 0 0]);
set(gca, 'color', [0.8 0.8 0.8]);
set(legend, 'Color', [0.7 0.7 0.7]);
xlabel 'Latitude';
ylabel 'Longitude';
hold off

```

```

%% Silhouette Function Used to Determine the Efficiency of the Clustering
figure;
[s,h] = silhouette(X,idx,'cityblock');
title 'Optimised Pump Station - Cluster Silhouette Values'

```

```

%% Manipulate Data for Extraction to KML

```

```

idxary = array2table (idx);
idxtable = [OptimisedPumpStations idxary];

```

```

ClustArng = sortrows(idxtable, 8);

```

```

ClustArng1 = ClustArng((ClustArng.idx == 1),1:8);
ClustArng2 = ClustArng((ClustArng.idx == 2),1:8);
ClustArng3 = ClustArng((ClustArng.idx == 3),1:8);
ClustArng4 = ClustArng((ClustArng.idx == 4),1:8);
ClustArng5 = ClustArng((ClustArng.idx == 5),1:8);
ClustArng6 = ClustArng((ClustArng.idx == 6),1:8);
ClustArng7 = ClustArng((ClustArng.idx == 7),1:8);
ClustArng8 = ClustArng((ClustArng.idx == 8),1:8);
ClustArng9 = ClustArng((ClustArng.idx == 9),1:8);
ClustArng10 = ClustArng((ClustArng.idx == 10),1:8);
ClustArng11 = ClustArng((ClustArng.idx == 11),1:8);
ClustArng12 = ClustArng((ClustArng.idx == 12),1:8);
ClustArng13 = ClustArng((ClustArng.idx == 13),1:8);
ClustArng14 = ClustArng((ClustArng.idx == 14),1:8);
ClustArng15 = ClustArng((ClustArng.idx == 15),1:8);
ClustArng16 = ClustArng((ClustArng.idx == 16),1:8);
ClustArng17 = ClustArng((ClustArng.idx == 17),1:8);
ClustArng18 = ClustArng((ClustArng.idx == 18),1:8);
ClustArng19 = ClustArng((ClustArng.idx == 19),1:8);
ClustArng20 = ClustArng((ClustArng.idx == 20),1:8);

```

```
%% Once the tables have been broken out extract data for KML
```

```
%Prep Cluster 1 Coordinate Data
```

```
ClustArng1Lat = table2array (ClustArng1(:,4));  
ClustArng1Lon = table2array (ClustArng1(:,5));  
ClustArng1FLOC = table2cell (ClustArng1(:,1));
```

```
%Prep Cluster 2 Coordinate Data
```

```
ClustArng2Lat = table2array (ClustArng2(:,4));  
ClustArng2Lon = table2array (ClustArng2(:,5));  
ClustArng2FLOC = table2cell (ClustArng2(:,1));
```

```
%Prep Cluster 3 Coordinate Data
```

```
ClustArng3Lat = table2array (ClustArng3(:,4));  
ClustArng3Lon = table2array (ClustArng3(:,5));  
ClustArng3FLOC = table2cell (ClustArng3(:,1));
```

```
%Prep Cluster 4 Coordinate Data
```

```
ClustArng4Lat = table2array (ClustArng4(:,4));  
ClustArng4Lon = table2array (ClustArng4(:,5));  
ClustArng4FLOC = table2cell (ClustArng4(:,1));
```

```
%Prep Cluster 5 Coordinate Data
```

```
ClustArng5Lat = table2array (ClustArng5(:,4));  
ClustArng5Lon = table2array (ClustArng5(:,5));  
ClustArng5FLOC = table2cell (ClustArng5(:,1));
```

```
%Prep Cluster 6 Coordinate Data
```

```
ClustArng6Lat = table2array (ClustArng6(:,4));  
ClustArng6Lon = table2array (ClustArng6(:,5));  
ClustArng6FLOC = table2cell (ClustArng6(:,1));
```

```
%Prep Cluster 7 Coordinate Data
```

```
ClustArng7Lat = table2array (ClustArng7(:,4));  
ClustArng7Lon = table2array (ClustArng7(:,5));  
ClustArng7FLOC = table2cell (ClustArng7(:,1));
```

```
%Prep Cluster 8 Coordinate Data
```

```
ClustArng8Lat = table2array (ClustArng8(:,4));  
ClustArng8Lon = table2array (ClustArng8(:,5));  
ClustArng8FLOC = table2cell (ClustArng8(:,1));
```

```
%Prep Cluster 9 Coordinate Data
```

```
ClustArng9Lat = table2array (ClustArng9(:,4));  
ClustArng9Lon = table2array (ClustArng9(:,5));  
ClustArng9FLOC = table2cell (ClustArng9(:,1));
```

```
%Prep Cluster 10 Coordinate Data
```

```
ClustArng10Lat = table2array (ClustArng10(:,4));  
ClustArng10Lon = table2array (ClustArng10(:,5));  
ClustArng10FLOC = table2cell (ClustArng10(:,1));
```

```

%Prep Cluster 11 Coordinate Data
ClustArng11Lat = table2array (ClustArng11(:,4));
ClustArng11Lon = table2array (ClustArng11(:,5));
ClustArng11FLOC = table2cell (ClustArng11(:,1));

%Prep Cluster 12 Coordinate Data
ClustArng12Lat = table2array (ClustArng12(:,4));
ClustArng12Lon = table2array (ClustArng12(:,5));
ClustArng12FLOC = table2cell (ClustArng12(:,1));

%Prep Cluster 13 Coordinate Data
ClustArng13Lat = table2array (ClustArng13(:,4));
ClustArng13Lon = table2array (ClustArng13(:,5));
ClustArng13FLOC = table2cell (ClustArng13(:,1));

%Prep Cluster 14 Coordinate Data
ClustArng14Lat = table2array (ClustArng14(:,4));
ClustArng14Lon = table2array (ClustArng14(:,5));
ClustArng14FLOC = table2cell (ClustArng14(:,1));

%Prep Cluster 15 Coordinate Data
ClustArng15Lat = table2array (ClustArng15(:,4));
ClustArng15Lon = table2array (ClustArng15(:,5));
ClustArng15FLOC = table2cell (ClustArng15(:,1));

%Prep Cluster 16 Coordinate Data
ClustArng16Lat = table2array (ClustArng16(:,4));
ClustArng16Lon = table2array (ClustArng16(:,5));
ClustArng16FLOC = table2cell (ClustArng16(:,1));

%Prep Cluster 17 Coordinate Data
ClustArng17Lat = table2array (ClustArng17(:,4));
ClustArng17Lon = table2array (ClustArng17(:,5));
ClustArng17FLOC = table2cell (ClustArng17(:,1));

%Prep Cluster 18 Coordinate Data
ClustArng18Lat = table2array (ClustArng18(:,4));
ClustArng18Lon = table2array (ClustArng18(:,5));
ClustArng18FLOC = table2cell (ClustArng18(:,1));

%Prep Cluster 19 Coordinate Data
ClustArng19Lat = table2array (ClustArng19(:,4));
ClustArng19Lon = table2array (ClustArng19(:,5));
ClustArng19FLOC = table2cell (ClustArng19(:,1));

%Prep Cluster 20 Coordinate Data
ClustArng20Lat = table2array (ClustArng20(:,4));
ClustArng20Lon = table2array (ClustArng20(:,5));
ClustArng20FLOC = table2cell (ClustArng20(:,1));

%% Export to KML

%Export Cluster 1
kmlwrite('ClustArng1', ClustArng1Lat, ClustArng1Lon, ...
        'Description', ClustArng1FLOC, 'name', ClustArng1FLOC);

```

```
%Export Cluster 2
kmlwrite('ClustArng2', ClustArng2Lat, ClustArng2Lon, ...
        'Description', ClustArng2FLOC, 'name', ClustArng2FLOC);

%Export Cluster 3
kmlwrite('ClustArng3', ClustArng3Lat, ClustArng3Lon, ...
        'Description', ClustArng3FLOC, 'name', ClustArng3FLOC);

%Export Cluster 4
kmlwrite('ClustArng4', ClustArng4Lat, ClustArng4Lon, ...
        'Description', ClustArng4FLOC, 'name', ClustArng4FLOC);

%Export Cluster 5
kmlwrite('ClustArng5', ClustArng5Lat, ClustArng5Lon, ...
        'Description', ClustArng5FLOC, 'name', ClustArng5FLOC);

%Export Cluster 6
kmlwrite('ClustArng6', ClustArng6Lat, ClustArng6Lon, ...
        'Description', ClustArng6FLOC, 'name', ClustArng6FLOC);

%Export Cluster 7
kmlwrite('ClustArng7', ClustArng7Lat, ClustArng7Lon, ...
        'Description', ClustArng7FLOC, 'name', ClustArng7FLOC);

%Export Cluster 8
kmlwrite('ClustArng8', ClustArng8Lat, ClustArng8Lon, ...
        'Description', ClustArng8FLOC, 'name', ClustArng8FLOC);

%Export Cluster 9
kmlwrite('ClustArng9', ClustArng9Lat, ClustArng9Lon, ...
        'Description', ClustArng9FLOC, 'name', ClustArng9FLOC);

%Export Cluster 10
kmlwrite('ClustArng10', ClustArng10Lat, ClustArng10Lon, ...
        'Description', ClustArng10FLOC, 'name', ClustArng10FLOC);

%Export Cluster 11
kmlwrite('ClustArng11', ClustArng11Lat, ClustArng11Lon, ...
        'Description', ClustArng11FLOC, 'name', ClustArng11FLOC);

%Export Cluster 12
kmlwrite('ClustArng12', ClustArng12Lat, ClustArng12Lon, ...
        'Description', ClustArng12FLOC, 'name', ClustArng12FLOC);

%Export Cluster 13
kmlwrite('ClustArng13', ClustArng13Lat, ClustArng13Lon, ...
        'Description', ClustArng13FLOC, 'name', ClustArng13FLOC);

%Export Cluster 14
kmlwrite('ClustArng14', ClustArng14Lat, ClustArng14Lon, ...
        'Description', ClustArng14FLOC, 'name', ClustArng14FLOC);

%Export Cluster 15
```

```
kmlwrite('ClustArng15', ClustArng15Lat, ClustArng15Lon, ...
        'Description', ClustArng15FLOC, 'name', ClustArng15FLOC);

%Export Cluster 16
kmlwrite('ClustArng16', ClustArng16Lat, ClustArng16Lon, ...
        'Description', ClustArng16FLOC, 'name', ClustArng16FLOC);

%Export Cluster 17
kmlwrite('ClustArng17', ClustArng17Lat, ClustArng17Lon, ...
        'Description', ClustArng17FLOC, 'name', ClustArng17FLOC);

%Export Cluster 18
kmlwrite('ClustArng18', ClustArng18Lat, ClustArng18Lon, ...
        'Description', ClustArng18FLOC, 'name', ClustArng18FLOC);

%Export Cluster 19
kmlwrite('ClustArng19', ClustArng19Lat, ClustArng19Lon, ...
        'Description', ClustArng19FLOC, 'name', ClustArng19FLOC);

%Export Cluster 20
kmlwrite('ClustArng20', ClustArng20Lat, ClustArng20Lon, ...
        'Description', ClustArng20FLOC, 'name', ClustArng20FLOC);
```

## KML output files for each cluster

Following the execution of the Mat-Code above, the KML files for each cluster were generated. These were then opened in Google Earth for inspection.

### 9.1 Cluster 1

```
<?xml version="1.0" encoding="utf-8"?>
<kml xmlns="http://www.opengis.net/kml/2.2">
  <Document>
    <name>ClustArng1</name>
    <Placemark>
      <Snippet maxLines="0"> </Snippet>
      <description>BEEDP2ZZ</description>
      <name>BEEDP2ZZ</name>
      <Point>
        <coordinates>-1.3078024,51.478224,0</coordinates>
      </Point>
    </Placemark>
    <Placemark>
      <Snippet maxLines="0"> </Snippet>
      <description>HAMP1ZZ</description>
      <name>HAMP1ZZ</name>
      <Point>
        <coordinates>-1.2992807,51.399973,0</coordinates>
      </Point>
    </Placemark>
    <Placemark>
      <Snippet maxLines="0"> </Snippet>
      <description>KNIGP3ZZ</description>
      <name>KNIGP3ZZ</name>
      <Point>
        <coordinates>-1.3930801,51.370392,0</coordinates>
      </Point>
    </Placemark>
    <Placemark>
      <Snippet maxLines="0"> </Snippet>
      <description>MILLPGZZ</description>
      <name>MILLPGZZ</name>
      <Point>
        <coordinates>-1.2412907,51.365281,0</coordinates>
      </Point>
    </Placemark>
    <Placemark>
      <Snippet maxLines="0"> </Snippet>
      <description>RUSSP4ZZ</description>
      <name>RUSSP4ZZ</name>
      <Point>
        <coordinates>-1.3376924,51.399837,0</coordinates>
      </Point>
    </Placemark>
    <Placemark>
      <Snippet maxLines="0"> </Snippet>
      <description>SHEEP5ZZ</description>
      <name>SHEEP5ZZ</name>
      <Point>
```

```

        <coordinates>-1.3227108,51.361086,0</coordinates>
    </Point>
</Placemark>
<Placemark>
    <Snippet maxLines="0"> </Snippet>
    <description>GRANP5ZZ</description>
    <name>GRANP5ZZ</name>
    <Point>
        <coordinates>-1.3533844,51.373695,0</coordinates>
    </Point>
</Placemark>
</Document>
</kml>

```

## 9.2 Cluster 2

```

<?xml version="1.0" encoding="utf-8"?>
<kml xmlns="http://www.opengis.net/kml/2.2">
    <Document>
        <name>ClustArng2</name>
        <Placemark>
            <Snippet maxLines="0"> </Snippet>
            <description>FEATP1ZZ</description>
            <name>FEATP1ZZ</name>
            <Point>
                <coordinates>0.2386163,51.826417,0</coordinates>
            </Point>
        </Placemark>
        <Placemark>
            <Snippet maxLines="0"> </Snippet>
            <description>FOSTP1ZZ</description>
            <name>FOSTP1ZZ</name>
            <Point>
                <coordinates>0.15934235,51.762236,0</coordinates>
            </Point>
        </Placemark>
        <Placemark>
            <Snippet maxLines="0"> </Snippet>
            <description>SPELP0ZZ</description>
            <name>SPELP0ZZ</name>
            <Point>
                <coordinates>0.15674239,51.835654,0</coordinates>
            </Point>
        </Placemark>
        <Placemark>
            <Snippet maxLines="0"> </Snippet>
            <description>STMIP1ZZ</description>
            <name>STMIP1ZZ</name>
            <Point>
                <coordinates>0.13629552,51.854776,0</coordinates>
            </Point>
        </Placemark>
        <Placemark>
            <Snippet maxLines="0"> </Snippet>
            <description>STONPCZZ</description>
            <name>STONPCZZ</name>

```



```

    <Point>
      <coordinates>0.22503679,51.812664,0</coordinates>
    </Point>
  </Placemark>
<Placemark>
  <Snippet maxLines="0"> </Snippet>
  <description>DRUCP1ZZ</description>
  <name>DRUCP1ZZ</name>
  <Point>
    <coordinates>0.14578739,51.965677,0</coordinates>
  </Point>
</Placemark>
</Document>
</kml>

```

### 9.3 Cluster 3

```

<?xml version="1.0" encoding="utf-8"?>
<kml xmlns="http://www.opengis.net/kml/2.2">
  <Document>
    <name>ClustArng3</name>
    <Placemark>
      <Snippet maxLines="0"> </Snippet>
      <description>ASCOP4ZZ</description>
      <name>ASCOP4ZZ</name>
      <Point>
        <coordinates>-0.71602688,51.495728,0</coordinates>
      </Point>
    </Placemark>
    <Placemark>
      <Snippet maxLines="0"> </Snippet>
      <description>BATHP3ZZ</description>
      <name>BATHP3ZZ</name>
      <Point>
        <coordinates>-0.69727223,51.523972,0</coordinates>
      </Point>
    </Placemark>
    <Placemark>
      <Snippet maxLines="0"> </Snippet>
      <description>CLIVP1ZZ</description>
      <name>CLIVP1ZZ</name>
      <Point>
        <coordinates>-0.7014496,51.538262,0</coordinates>
      </Point>
    </Placemark>
    <Placemark>
      <Snippet maxLines="0"> </Snippet>
      <description>MONKP1ZZ</description>
      <name>MONKP1ZZ</name>
      <Point>
        <coordinates>-0.68529442,51.494408,0</coordinates>
      </Point>
    </Placemark>
    <Placemark>
      <Snippet maxLines="0"> </Snippet>
      <description>SOUTP3ZZ</description>

```

```

    <name>SOUTP3ZZ</name>
    <Point>
      <coordinates>-0.65815855,51.502625,0</coordinates>
    </Point>
  </Placemark>
<Placemark>
  <Snippet maxLines="0"> </Snippet>
  <description>TITHP1ZZ</description>
  <name>TITHP1ZZ</name>
  <Point>
    <coordinates>-0.69034771,51.495516,0</coordinates>
  </Point>
</Placemark>
<Placemark>
  <Snippet maxLines="0"> </Snippet>
  <description>ANNEP1ZZ</description>
  <name>ANNEP1ZZ</name>
  <Point>
    <coordinates>-0.75975617,51.426376,0</coordinates>
  </Point>
</Placemark>
<Placemark>
  <Snippet maxLines="0"> </Snippet>
  <description>MAIDP1ZZ</description>
  <name>MAIDP1ZZ</name>
  <Point>
    <coordinates>-0.69992558,51.449988,0</coordinates>
  </Point>
</Placemark>
<Placemark>
  <Snippet maxLines="0"> </Snippet>
  <description>WINKP1ZZ</description>
  <name>WINKP1ZZ</name>
  <Point>
    <coordinates>-0.70341793,51.43796,0</coordinates>
  </Point>
</Placemark>
</Document>
</kml>

```

## 9.4 Cluster 4

```

<?xml version="1.0" encoding="utf-8"?>
<kml xmlns="http://www.opengis.net/kml/2.2">
  <Document>
    <name>ClustArng4</name>
    <Placemark>
      <Snippet maxLines="0"> </Snippet>
      <description>GRIMP1ZZ</description>
      <name>GRIMP1ZZ</name>
      <Point>
        <coordinates>-1.3180963,52.061355,0</coordinates>
      </Point>
    </Placemark>
    <Placemark>
      <Snippet maxLines="0"> </Snippet>

```

```

    <description>KINGPLZZ</description>
    <name>KINGPLZZ</name>
    <Point>
      <coordinates>-1.280117,52.024824,0</coordinates>
    </Point>
  </Placemark>
  <Placemark>
    <Snippet maxLines="0"> </Snippet>
    <description>MARSP3ZZ</description>
    <name>MARSP3ZZ</name>
    <Point>
      <coordinates>-1.2178571,52.073158,0</coordinates>
    </Point>
  </Placemark>
  <Placemark>
    <Snippet maxLines="0"> </Snippet>
    <description>MIDDP1ZZ</description>
    <name>MIDDP1ZZ</name>
    <Point>
      <coordinates>-1.2783416,52.071745,0</coordinates>
    </Point>
  </Placemark>
  <Placemark>
    <Snippet maxLines="0"> </Snippet>
    <description>WALTP2ZZ</description>
    <name>WALTP2ZZ</name>
    <Point>
      <coordinates>-1.262551,52.008208,0</coordinates>
    </Point>
  </Placemark>
</Document>
</kml>

```

## 9.5 Cluster 5

```

<?xml version="1.0" encoding="utf-8"?>
<kml xmlns="http://www.opengis.net/kml/2.2">
  <Document>
    <name>ClustArng5</name>
    <Placemark>
      <Snippet maxLines="0"> </Snippet>
      <description>LAWRP3ZZ</description>
      <name>LAWRP3ZZ</name>
      <Point>
        <coordinates>0.0040624445,51.784779,0</coordinates>
      </Point>
    </Placemark>
    <Placemark>
      <Snippet maxLines="0"> </Snippet>
      <description>ROBEP1ZZ</description>
      <name>ROBEP1ZZ</name>
      <Point>
        <coordinates>-0.025425324,51.721729,0</coordinates>
      </Point>
    </Placemark>
    <Placemark>
      <Snippet maxLines="0"> </Snippet>

```

```

    <description>STANPLZZ</description>
    <name>STANPLZZ</name>
    <Point>
      <coordinates>-0.011913624,51.749522,0</coordinates>
    </Point>
  </Placemark>
<Placemark>
  <Snippet maxLines="0"> </Snippet>
  <description>KNOWP2ZZ</description>
  <name>KNOWP2ZZ</name>
  <Point>
    <coordinates>-0.015585325,51.755986,0</coordinates>
  </Point>
</Placemark>
<Placemark>
  <Snippet maxLines="0"> </Snippet>
  <description>LYNCP1ZZ</description>
  <name>LYNCP1ZZ</name>
  <Point>
    <coordinates>-0.0042191504,51.759418,0</coordinates>
  </Point>
</Placemark>
<Placemark>
  <Snippet maxLines="0"> </Snippet>
  <description>PRINP2ZZ</description>
  <name>PRINP2ZZ</name>
  <Point>
    <coordinates>-0.022296527,51.66899,0</coordinates>
  </Point>
</Placemark>
<Placemark>
  <Snippet maxLines="0"> </Snippet>
  <description>ROUNP1ZZ</description>
  <name>ROUNP1ZZ</name>
  <Point>
    <coordinates>-0.10919858,51.667544,0</coordinates>
  </Point>
</Placemark>
</Document>
</kml>

```

## 9.6 Cluster 6

```

<?xml version="1.0" encoding="utf-8"?>
<kml xmlns="http://www.opengis.net/kml/2.2">
  <Document>
    <name>ClustArng6</name>
    <Placemark>
      <Snippet maxLines="0"> </Snippet>
      <description>CAPEP1ZZ</description>
      <name>CAPEP1ZZ</name>
      <Point>
        <coordinates>-0.31302564,51.1561,0</coordinates>
      </Point>
    </Placemark>
    <Placemark>
      <Snippet maxLines="0"> </Snippet>

```

```

    <description>BRICP2ZZ</description>
    <name>BRICP2ZZ</name>
    <Point>
      <coordinates>-0.40550834,51.210715,0</coordinates>
    </Point>
  </Placemark>
</Placemark>
  <Snippet maxLines="0"> </Snippet>
  <description>ELLEP1ZZ</description>
  <name>ELLEP1ZZ</name>
  <Point>
    <coordinates>-0.43066905,51.108961,0</coordinates>
  </Point>
</Placemark>
</Document>
</kml>

```

## 9.7 Cluster 7

```

<?xml version="1.0" encoding="utf-8"?>
<kml xmlns="http://www.opengis.net/kml/2.2">
  <Document>
    <name>ClustArng7</name>
    <Placemark>
      <Snippet maxLines="0"> </Snippet>
      <description>JACOP1ZZ</description>
      <name>JACOP1ZZ</name>
      <Point>
        <coordinates>-0.56934731,51.265286,0</coordinates>
      </Point>
    </Placemark>
    <Placemark>
      <Snippet maxLines="0"> </Snippet>
      <description>BONNP1ZZ</description>
      <name>BONNP1ZZ</name>
      <Point>
        <coordinates>-0.55976128,51.294987,0</coordinates>
      </Point>
    </Placemark>
    <Placemark>
      <Snippet maxLines="0"> </Snippet>
      <description>CARTP6ZZ</description>
      <name>CARTP6ZZ</name>
      <Point>
        <coordinates>-0.54203309,51.294093,0</coordinates>
      </Point>
    </Placemark>
    <Placemark>
      <Snippet maxLines="0"> </Snippet>
      <description>CHARP5ZZ</description>
      <name>CHARP5ZZ</name>
      <Point>
        <coordinates>-0.63639109,51.392373,0</coordinates>
      </Point>
    </Placemark>
    <Placemark>
      <Snippet maxLines="0"> </Snippet>

```

```
<description>CLAPP2ZZ</description>
<name>CLAPP2ZZ</name>
<Point>
  <coordinates>-0.61469549,51.348309,0</coordinates>
</Point>
</Placemark>
<Placemark>
  <Snippet maxLines="0"> </Snippet>
  <description>EDENP1ZZ</description>
  <name>EDENP1ZZ</name>
  <Point>
    <coordinates>-0.47352589,51.335799,0</coordinates>
  </Point>
</Placemark>
<Placemark>
  <Snippet maxLines="0"> </Snippet>
  <description>GOLDP1ZZ</description>
  <name>GOLDP1ZZ</name>
  <Point>
    <coordinates>-0.56943943,51.317704,0</coordinates>
  </Point>
</Placemark>
<Placemark>
  <Snippet maxLines="0"> </Snippet>
  <description>OWOKP1ZZ</description>
  <name>OWOKP1ZZ</name>
  <Point>
    <coordinates>-0.54643174,51.302412,0</coordinates>
  </Point>
</Placemark>
<Placemark>
  <Snippet maxLines="0"> </Snippet>
  <description>PARLP1ZZ</description>
  <name>PARLP1ZZ</name>
  <Point>
    <coordinates>-0.59320624,51.323225,0</coordinates>
  </Point>
</Placemark>
<Placemark>
  <Snippet maxLines="0"> </Snippet>
  <description>SUTTP5ZZ</description>
  <name>SUTTP5ZZ</name>
  <Point>
    <coordinates>-0.55727433,51.288302,0</coordinates>
  </Point>
</Placemark>
<Placemark>
  <Snippet maxLines="0"> </Snippet>
  <description>WHITP5ZZ</description>
  <name>WHITP5ZZ</name>
  <Point>
    <coordinates>-0.54442145,51.310183,0</coordinates>
  </Point>
</Placemark>
</Document>
</kml>
```

## 9.8 Cluster 8

```
<?xml version="1.0" encoding="utf-8"?>
<kml xmlns="http://www.opengis.net/kml/2.2">
  <Document>
    <name>ClustArng8</name>
    <Placemark>
      <Snippet maxLines="0"> </Snippet>
      <description>BEGBP1ZZ</description>
      <name>BEGBP1ZZ</name>
      <Point>
        <coordinates>-1.3136348,51.820938,0</coordinates>
      </Point>
    </Placemark>
    <Placemark>
      <Snippet maxLines="0"> </Snippet>
      <description>BOTLP1ZZ</description>
      <name>BOTLP1ZZ</name>
      <Point>
        <coordinates>-1.282085,51.752938,0</coordinates>
      </Point>
    </Placemark>
    <Placemark>
      <Snippet maxLines="0"> </Snippet>
      <description>BROOP1ZZ</description>
      <name>BROOP1ZZ</name>
      <Point>
        <coordinates>-1.351662,51.850231,0</coordinates>
      </Point>
    </Placemark>
    <Placemark>
      <Snippet maxLines="0"> </Snippet>
      <description>CASSP1ZZ</description>
      <name>CASSP1ZZ</name>
      <Point>
        <coordinates>-1.3342603,51.791773,0</coordinates>
      </Point>
    </Placemark>
    <Placemark>
      <Snippet maxLines="0"> </Snippet>
      <description>COLGP1ZZ</description>
      <name>COLGP1ZZ</name>
      <Point>
        <coordinates>-1.3143305,51.740624,0</coordinates>
      </Point>
    </Placemark>
    <Placemark>
      <Snippet maxLines="0"> </Snippet>
      <description>ISLIP1ZZ</description>
      <name>ISLIP1ZZ</name>
      <Point>
        <coordinates>-1.2353745,51.821004,0</coordinates>
      </Point>
    </Placemark>
    <Placemark>
      <Snippet maxLines="0"> </Snippet>
      <description>LHEYP2ZZ</description>
```

```
<name>LHEY2ZZ</name>
<Point>
  <coordinates>-1.2985285,51.918249,0</coordinates>
</Point>
</Placemark>
<Placemark>
  <Snippet maxLines="0"> </Snippet>
  <description>LHEY1ZZ</description>
  <name>LHEY1ZZ</name>
  <Point>
    <coordinates>-1.2899116,51.920688,0</coordinates>
  </Point>
</Placemark>
<Placemark>
  <Snippet maxLines="0"> </Snippet>
  <description>SHIPP3ZZ</description>
  <name>SHIPP3ZZ</name>
  <Point>
    <coordinates>-1.3005259,51.847672,0</coordinates>
  </Point>
</Placemark>
<Placemark>
  <Snippet maxLines="0"> </Snippet>
  <description>TACKP1ZZ</description>
  <name>TACKP1ZZ</name>
  <Point>
    <coordinates>-1.3013239,51.880522,0</coordinates>
  </Point>
</Placemark>
<Placemark>
  <Snippet maxLines="0"> </Snippet>
  <description>LINCP1ZZ</description>
  <name>LINCP1ZZ</name>
  <Point>
    <coordinates>-1.3527874,51.828434,0</coordinates>
  </Point>
</Placemark>
<Placemark>
  <Snippet maxLines="0"> </Snippet>
  <description>THRUP1ZZ</description>
  <name>THRUP1ZZ</name>
  <Point>
    <coordinates>-1.3056341,51.837408,0</coordinates>
  </Point>
</Placemark>
<Placemark>
  <Snippet maxLines="0"> </Snippet>
  <description>WOOTP1ZZ</description>
  <name>WOOTP1ZZ</name>
  <Point>
    <coordinates>-1.3630313,51.872735,0</coordinates>
  </Point>
</Placemark>
<Placemark>
  <Snippet maxLines="0"> </Snippet>
  <description>YARNP1ZZ</description>
  <name>YARNP1ZZ</name>
```



```

    <Point>
      <coordinates>-1.3074032,51.806273,0</coordinates>
    </Point>
  </Placemark>
</Document>
</kml>

```

## 9.9 Cluster 9

```

<?xml version="1.0" encoding="utf-8"?>
<kml xmlns="http://www.opengis.net/kml/2.2">
  <Document>
    <name>ClustArng9</name>
    <Placemark>
      <Snippet maxLines="0"> </Snippet>
      <description>APOLP1ZZ</description>
      <name>APOLP1ZZ</name>
      <Point>
        <coordinates>-0.8529379,51.108335,0</coordinates>
      </Point>
    </Placemark>
    <Placemark>
      <Snippet maxLines="0"> </Snippet>
      <description>ARFOP1ZZ</description>
      <name>ARFOP1ZZ</name>
      <Point>
        <coordinates>-0.81883794,51.125243,0</coordinates>
      </Point>
    </Placemark>
    <Placemark>
      <Snippet maxLines="0"> </Snippet>
      <description>CHALP2ZZ</description>
      <name>CHALP2ZZ</name>
      <Point>
        <coordinates>-0.85317538,51.112015,0</coordinates>
      </Point>
    </Placemark>
    <Placemark>
      <Snippet maxLines="0"> </Snippet>
      <description>CHAPP1ZZ</description>
      <name>CHAPP1ZZ</name>
      <Point>
        <coordinates>-0.84863648,51.121629,0</coordinates>
      </Point>
    </Placemark>
    <Placemark>
      <Snippet maxLines="0"> </Snippet>
      <description>CHURP7ZZ</description>
      <name>CHURP7ZZ</name>
      <Point>
        <coordinates>-0.78231864,51.135893,0</coordinates>
      </Point>
    </Placemark>
    <Placemark>
      <Snippet maxLines="0"> </Snippet>
      <description>HAMIP1ZZ</description>
      <name>HAMIP1ZZ</name>

```

```
<Point>
  <coordinates>-0.84628711,51.114411,0</coordinates>
</Point>
</Placemark>
<Placemark>
  <Snippet maxLines="0"> </Snippet>
  <description>HEADP1ZZ</description>
  <name>HEADP1ZZ</name>
  <Point>
    <coordinates>-0.84162467,51.115184,0</coordinates>
  </Point>
</Placemark>
<Placemark>
  <Snippet maxLines="0"> </Snippet>
  <description>HOGMP2ZZ</description>
  <name>HOGMP2ZZ</name>
  <Point>
    <coordinates>-0.87790493,51.104899,0</coordinates>
  </Point>
</Placemark>
<Placemark>
  <Snippet maxLines="0"> </Snippet>
  <description>KINGPHZZ</description>
  <name>KINGPHZZ</name>
  <Point>
    <coordinates>-0.87545991,51.135612,0</coordinates>
  </Point>
</Placemark>
<Placemark>
  <Snippet maxLines="0"> </Snippet>
  <description>LIONP2ZZ</description>
  <name>LIONP2ZZ</name>
  <Point>
    <coordinates>-0.90246677,51.114799,0</coordinates>
  </Point>
</Placemark>
<Placemark>
  <Snippet maxLines="0"> </Snippet>
  <description>MILLP6ZZ</description>
  <name>MILLP6ZZ</name>
  <Point>
    <coordinates>-0.78548872,51.169783,0</coordinates>
  </Point>
</Placemark>
<Placemark>
  <Snippet maxLines="0"> </Snippet>
  <description>MONUP0ZZ</description>
  <name>MONUP0ZZ</name>
  <Point>
    <coordinates>-0.85710271,51.104536,0</coordinates>
  </Point>
</Placemark>
<Placemark>
  <Snippet maxLines="0"> </Snippet>
  <description>PASSP1ZZ</description>
  <name>PASSP1ZZ</name>
  <Point>
```

```

        <coordinates>-0.82918183,51.103837,0</coordinates>
    </Point>
</Placemark>
<Placemark>
    <Snippet maxLines="0"> </Snippet>
    <description>PEARP1ZZ</description>
    <name>PEARP1ZZ</name>
    <Point>
        <coordinates>-0.81282487,51.182527,0</coordinates>
    </Point>
</Placemark>
<Placemark>
    <Snippet maxLines="0"> </Snippet>
    <description>RAILP1ZZ</description>
    <name>RAILP1ZZ</name>
    <Point>
        <coordinates>-0.86863871,51.182531,0</coordinates>
    </Point>
</Placemark>
<Placemark>
    <Snippet maxLines="0"> </Snippet>
    <description>SELBP1ZZ</description>
    <name>SELBP1ZZ</name>
    <Point>
        <coordinates>-0.93990509,51.098859,0</coordinates>
    </Point>
</Placemark>
<Placemark>
    <Snippet maxLines="0"> </Snippet>
    <description>MEADP8ZZ</description>
    <name>MEADP8ZZ</name>
    <Point>
        <coordinates>-0.77319182,51.137803,0</coordinates>
    </Point>
</Placemark>
<Placemark>
    <Snippet maxLines="0"> </Snippet>
    <description>TULLP1ZZ</description>
    <name>TULLP1ZZ</name>
    <Point>
        <coordinates>-0.83440225,51.106398,0</coordinates>
    </Point>
</Placemark>
<Placemark>
    <Snippet maxLines="0"> </Snippet>
    <description>WALLP1ZZ</description>
    <name>WALLP1ZZ</name>
    <Point>
        <coordinates>-0.85411468,51.100604,0</coordinates>
    </Point>
</Placemark>
</Document>
</kml>

```

## 9.10 Cluster 10

```
<?xml version="1.0" encoding="utf-8"?>
```

```

<kml xmlns="http://www.opengis.net/kml/2.2">
  <Document>
    <name>ClustArng10</name>
    <Placemark>
      <Snippet maxLines="0"> </Snippet>
      <description>BREN2ZZ</description>
      <name>BREN2ZZ</name>
      <Point>
        <coordinates>-0.30436212,51.481795,0</coordinates>
      </Point>
    </Placemark>
    <Placemark>
      <Snippet maxLines="0"> </Snippet>
      <description>GLEN2ZZ</description>
      <name>GLEN2ZZ</name>
      <Point>
        <coordinates>-0.38481103,51.522937,0</coordinates>
      </Point>
    </Placemark>
    <Placemark>
      <Snippet maxLines="0"> </Snippet>
      <description>GLAN2ZZ</description>
      <name>GLAN2ZZ</name>
      <Point>
        <coordinates>-0.34316907,51.504605,0</coordinates>
      </Point>
    </Placemark>
    <Placemark>
      <Snippet maxLines="0"> </Snippet>
      <description>QUAIP4ZZ</description>
      <name>QUAIP4ZZ</name>
      <Point>
        <coordinates>-0.26271097,51.560228,0</coordinates>
      </Point>
    </Placemark>
    <Placemark>
      <Snippet maxLines="0"> </Snippet>
      <description>TRUMP1ZZ</description>
      <name>TRUMP1ZZ</name>
      <Point>
        <coordinates>-0.3376823,51.500562,0</coordinates>
      </Point>
    </Placemark>
  </Document>
</kml>

```

### 9.11 Cluster 11

```

<?xml version="1.0" encoding="utf-8"?>
<kml xmlns="http://www.opengis.net/kml/2.2">
  <Document>
    <name>ClustArng11</name>
    <Placemark>
      <Snippet maxLines="0"> </Snippet>
      <description>NMILP1ZZ</description>
      <name>NMILP1ZZ</name>
      <Point>

```

```
    <coordinates>-0.90781109,51.359195,0</coordinates>
  </Point>
</Placemark>
<Placemark>
  <Snippet maxLines="0"> </Snippet>
  <description>FOXLP1ZZ</description>
  <name>FOXLP1ZZ</name>
  <Point>
    <coordinates>-0.79739956,51.42907,0</coordinates>
  </Point>
</Placemark>
<Placemark>
  <Snippet maxLines="0"> </Snippet>
  <description>ANDRP1ZZ</description>
  <name>ANDRP1ZZ</name>
  <Point>
    <coordinates>-0.88285623,51.505196,0</coordinates>
  </Point>
</Placemark>
<Placemark>
  <Snippet maxLines="0"> </Snippet>
  <description>CAMPP2ZZ</description>
  <name>CAMPP2ZZ</name>
  <Point>
    <coordinates>-0.86906086,51.505459,0</coordinates>
  </Point>
</Placemark>
<Placemark>
  <Snippet maxLines="0"> </Snippet>
  <description>DEANP1ZZ</description>
  <name>DEANP1ZZ</name>
  <Point>
    <coordinates>-0.90741247,51.535136,0</coordinates>
  </Point>
</Placemark>
<Placemark>
  <Snippet maxLines="0"> </Snippet>
  <description>FRIDP1ZZ</description>
  <name>FRIDP1ZZ</name>
  <Point>
    <coordinates>-0.90128133,51.536481,0</coordinates>
  </Point>
</Placemark>
<Placemark>
  <Snippet maxLines="0"> </Snippet>
  <description>HSTRP5ZZ</description>
  <name>HSTRP5ZZ</name>
  <Point>
    <coordinates>-0.86866694,51.476555,0</coordinates>
  </Point>
</Placemark>
<Placemark>
  <Snippet maxLines="0"> </Snippet>
  <description>HOGMP1ZZ</description>
  <name>HOGMP1ZZ</name>
  <Point>
    <coordinates>-0.85174445,51.461195,0</coordinates>
```

```
</Point>
</Placemark>
<Placemark>
  <Snippet maxLines="0"> </Snippet>
  <description>MERRP3ZZ</description>
  <name>MERRP3ZZ</name>
  <Point>
    <coordinates>-0.87122442,51.437097,0</coordinates>
  </Point>
</Placemark>
<Placemark>
  <Snippet maxLines="0"> </Snippet>
  <description>RADBP1ZZ</description>
  <name>RADBP1ZZ</name>
  <Point>
    <coordinates>-0.93047263,51.494256,0</coordinates>
  </Point>
</Placemark>
<Placemark>
  <Snippet maxLines="0"> </Snippet>
  <description>CENTP3ZZ</description>
  <name>CENTP3ZZ</name>
  <Point>
    <coordinates>-0.9239803,51.479998,0</coordinates>
  </Point>
</Placemark>
<Placemark>
  <Snippet maxLines="0"> </Snippet>
  <description>FREN1ZZ</description>
  <name>FREN1ZZ</name>
  <Point>
    <coordinates>-0.91742139,51.47724,0</coordinates>
  </Point>
</Placemark>
<Placemark>
  <Snippet maxLines="0"> </Snippet>
  <description>STSAP1ZZ</description>
  <name>STSAP1ZZ</name>
  <Point>
    <coordinates>-0.98328287,51.442986,0</coordinates>
  </Point>
</Placemark>
<Placemark>
  <Snippet maxLines="0"> </Snippet>
  <description>THAMPEZZ</description>
  <name>THAMPEZZ</name>
  <Point>
    <coordinates>-0.93253756,51.461958,0</coordinates>
  </Point>
</Placemark>
<Placemark>
  <Snippet maxLines="0"> </Snippet>
  <description>UNIVP1ZZ</description>
  <name>UNIVP1ZZ</name>
  <Point>
    <coordinates>-0.94336803,51.443632,0</coordinates>
  </Point>
</Placemark>
```

```
    </Placemark>
  </Document>
</kml>
```

## 9.12 Cluster 12

```
<?xml version="1.0" encoding="utf-8"?>
<kml xmlns="http://www.opengis.net/kml/2.2">
  <Document>
    <name>ClustArng12</name>
    <Placemark>
      <Snippet maxLines="0"> </Snippet>
      <description>ALDEP6ZZ</description>
      <name>ALDEP6ZZ</name>
      <Point>
        <coordinates>-0.73528503,51.241828,0</coordinates>
      </Point>
    </Placemark>
    <Placemark>
      <Snippet maxLines="0"> </Snippet>
      <description>HAWLP2ZZ</description>
      <name>HAWLP2ZZ</name>
      <Point>
        <coordinates>-0.76412439,51.316071,0</coordinates>
      </Point>
    </Placemark>
    <Placemark>
      <Snippet maxLines="0"> </Snippet>
      <description>MINLP1ZZ</description>
      <name>MINLP1ZZ</name>
      <Point>
        <coordinates>-0.83194957,51.293027,0</coordinates>
      </Point>
    </Placemark>
    <Placemark>
      <Snippet maxLines="0"> </Snippet>
      <description>MOULP1ZZ</description>
      <name>MOULP1ZZ</name>
      <Point>
        <coordinates>-0.84150552,51.348694,0</coordinates>
      </Point>
    </Placemark>
    <Placemark>
      <Snippet maxLines="0"> </Snippet>
      <description>NEWTP1ZZ</description>
      <name>NEWTP1ZZ</name>
      <Point>
        <coordinates>-0.74496705,51.304015,0</coordinates>
      </Point>
    </Placemark>
    <Placemark>
      <Snippet maxLines="0"> </Snippet>
      <description>OLANP1ZZ</description>
      <name>OLANP1ZZ</name>
      <Point>
        <coordinates>-0.73484704,51.250483,0</coordinates>
      </Point>
    </Placemark>
  </Document>
</kml>
```

```

</Placemark>
<Placemark>
  <Snippet maxLines="0"> </Snippet>
  <description>SYCAP1ZZ</description>
  <name>SYCAP1ZZ</name>
  <Point>
    <coordinates>-0.7380662,51.281542,0</coordinates>
  </Point>
</Placemark>
<Placemark>
  <Snippet maxLines="0"> </Snippet>
  <description>THORP3ZZ</description>
  <name>THORP3ZZ</name>
  <Point>
    <coordinates>-0.77168042,51.32543,0</coordinates>
  </Point>
</Placemark>
<Placemark>
  <Snippet maxLines="0"> </Snippet>
  <description>TILFP1ZZ</description>
  <name>TILFP1ZZ</name>
  <Point>
    <coordinates>-0.7543666,51.184014,0</coordinates>
  </Point>
</Placemark>
<Placemark>
  <Snippet maxLines="0"> </Snippet>
  <description>WHITP4ZZ</description>
  <name>WHITP4ZZ</name>
  <Point>
    <coordinates>-0.7956239,51.297318,0</coordinates>
  </Point>
</Placemark>
<Placemark>
  <Snippet maxLines="0"> </Snippet>
  <description>WHITPCZZ</description>
  <name>WHITPCZZ</name>
  <Point>
    <coordinates>-0.73431458,51.280836,0</coordinates>
  </Point>
</Placemark>
<Placemark>
  <Snippet maxLines="0"> </Snippet>
  <description>WILLP9ZZ</description>
  <name>WILLP9ZZ</name>
  <Point>
    <coordinates>-0.72922889,51.250009,0</coordinates>
  </Point>
</Placemark>
</Document>
</kml>

```

### 9.13 Cluster 13

```

<?xml version="1.0" encoding="utf-8"?>
<kml xmlns="http://www.opengis.net/kml/2.2">

```



```
<Document>
  <name>ClustArng13</name>
  <Placemark>
    <Snippet maxLines="0"> </Snippet>
    <description>BURCP2ZZ</description>
    <name>BURCP2ZZ</name>
    <Point>
      <coordinates>-1.1807394,51.658955,0</coordinates>
    </Point>
  </Placemark>
  <Placemark>
    <Snippet maxLines="0"> </Snippet>
    <description>CHESP1ZZ</description>
    <name>CHESP1ZZ</name>
    <Point>
      <coordinates>-1.1826894,51.65744,0</coordinates>
    </Point>
  </Placemark>
  <Placemark>
    <Snippet maxLines="0"> </Snippet>
    <description>CHURP8ZZ</description>
    <name>CHURP8ZZ</name>
    <Point>
      <coordinates>-1.1833722,51.637133,0</coordinates>
    </Point>
  </Placemark>
  <Placemark>
    <Snippet maxLines="0"> </Snippet>
    <description>DRAYP2ZZ</description>
    <name>DRAYP2ZZ</name>
    <Point>
      <coordinates>-1.3150773,51.63748,0</coordinates>
    </Point>
  </Placemark>
  <Placemark>
    <Snippet maxLines="0"> </Snippet>
    <description>FRILP2ZZ</description>
    <name>FRILP2ZZ</name>
    <Point>
      <coordinates>-1.3609709,51.67445,0</coordinates>
    </Point>
  </Placemark>
  <Placemark>
    <Snippet maxLines="0"> </Snippet>
    <description>HENLP2ZZ</description>
    <name>HENLP2ZZ</name>
    <Point>
      <coordinates>-1.2283093,51.713009,0</coordinates>
    </Point>
  </Placemark>
  <Placemark>
    <Snippet maxLines="0"> </Snippet>
    <description>KENNP2ZZ</description>
    <name>KENNP2ZZ</name>
    <Point>
      <coordinates>-1.2353048,51.704153,0</coordinates>
    </Point>
  </Placemark>

```

```
</Placemark>
<Placemark>
  <Snippet maxLines="0"> </Snippet>
  <description>KENNP4ZZ</description>
  <name>KENNP4ZZ</name>
  <Point>
    <coordinates>-1.2272801,51.688456,0</coordinates>
  </Point>
</Placemark>
<Placemark>
  <Snippet maxLines="0"> </Snippet>
  <description>STEV1ZZ</description>
  <name>STEV1ZZ</name>
  <Point>
    <coordinates>-1.316407,51.625925,0</coordinates>
  </Point>
</Placemark>
<Placemark>
  <Snippet maxLines="0"> </Snippet>
  <description>TOLL1ZZ</description>
  <name>TOLL1ZZ</name>
  <Point>
    <coordinates>-1.266372,51.651482,0</coordinates>
  </Point>
</Placemark>
<Placemark>
  <Snippet maxLines="0"> </Snippet>
  <description>BLEW1ZZ</description>
  <name>BLEW1ZZ</name>
  <Point>
    <coordinates>-1.2364201,51.571546,0</coordinates>
  </Point>
</Placemark>
<Placemark>
  <Snippet maxLines="0"> </Snippet>
  <description>CROFP2ZZ</description>
  <name>CROFP2ZZ</name>
  <Point>
    <coordinates>-1.2384735,51.592006,0</coordinates>
  </Point>
</Placemark>
<Placemark>
  <Snippet maxLines="0"> </Snippet>
  <description>ESSOP1ZZ</description>
  <name>ESSOP1ZZ</name>
  <Point>
    <coordinates>-1.3109373,51.60648,0</coordinates>
  </Point>
</Placemark>
<Placemark>
  <Snippet maxLines="0"> </Snippet>
  <description>FIRTP1ZZ</description>
  <name>FIRTP1ZZ</name>
  <Point>
    <coordinates>-1.1404258,51.601256,0</coordinates>
  </Point>
</Placemark>
```

```
<Placemark>
  <Snippet maxLines="0"> </Snippet>
  <description>HARWP2ZZ</description>
  <name>HARWP2ZZ</name>
  <Point>
    <coordinates>-1.2815723,51.60518,0</coordinates>
  </Point>
</Placemark>
<Placemark>
  <Snippet maxLines="0"> </Snippet>
  <description>MARTP2ZZ</description>
  <name>MARTP2ZZ</name>
  <Point>
    <coordinates>-1.166773,51.647185,0</coordinates>
  </Point>
</Placemark>
<Placemark>
  <Snippet maxLines="0"> </Snippet>
  <description>READP1ZZ</description>
  <name>READP1ZZ</name>
  <Point>
    <coordinates>-1.1266724,51.594141,0</coordinates>
  </Point>
</Placemark>
<Placemark>
  <Snippet maxLines="0"> </Snippet>
  <description>SLADP2ZZ</description>
  <name>SLADP2ZZ</name>
  <Point>
    <coordinates>-1.1508123,51.610269,0</coordinates>
  </Point>
</Placemark>
<Placemark>
  <Snippet maxLines="0"> </Snippet>
  <description>UPTOP1ZZ</description>
  <name>UPTOP1ZZ</name>
  <Point>
    <coordinates>-1.2552033,51.578824,0</coordinates>
  </Point>
</Placemark>
<Placemark>
  <Snippet maxLines="0"> </Snippet>
  <description>WHARP3ZZ</description>
  <name>WHARP3ZZ</name>
  <Point>
    <coordinates>-1.1420667,51.629115,0</coordinates>
  </Point>
</Placemark>
<Placemark>
  <Snippet maxLines="0"> </Snippet>
  <description>WINTP1ZZ</description>
  <name>WINTP1ZZ</name>
  <Point>
    <coordinates>-1.1259751,51.593614,0</coordinates>
  </Point>
</Placemark>
<Placemark>
```

```

    <Snippet maxLines="0"> </Snippet>
    <description>NMORP1ZZ</description>
    <name>NMORP1ZZ</name>
    <Point>
      <coordinates>-1.188946,51.603309,0</coordinates>
    </Point>
  </Placemark>
</Document>
</kml>

```

## 9.14 Cluster 14

```

<?xml version="1.0" encoding="utf-8"?>
<kml xmlns="http://www.opengis.net/kml/2.2">
  <Document>
    <name>ClustArng14</name>
    <Placemark>
      <Snippet maxLines="0"> </Snippet>
      <description>ALBEP2ZZ</description>
      <name>ALBEP2ZZ</name>
      <Point>
        <coordinates>-0.12648159,51.171912,0</coordinates>
      </Point>
    </Placemark>
    <Placemark>
      <Snippet maxLines="0"> </Snippet>
      <description>CHARPAZZ</description>
      <name>CHARPAZZ</name>
      <Point>
        <coordinates>-0.21245199,51.155739,0</coordinates>
      </Point>
    </Placemark>
    <Placemark>
      <Snippet maxLines="0"> </Snippet>
      <description>COPTP1ZZ</description>
      <name>COPTP1ZZ</name>
      <Point>
        <coordinates>-0.13251783,51.137925,0</coordinates>
      </Point>
    </Placemark>
    <Placemark>
      <Snippet maxLines="0"> </Snippet>
      <description>HOLMP3ZZ</description>
      <name>HOLMP3ZZ</name>
      <Point>
        <coordinates>-0.15449338,51.2485,0</coordinates>
      </Point>
    </Placemark>
    <Placemark>
      <Snippet maxLines="0"> </Snippet>
      <description>HUNTP1ZZ</description>
      <name>HUNTP1ZZ</name>
      <Point>
        <coordinates>-0.19491032,51.249365,0</coordinates>
      </Point>
    </Placemark>
  </Document>
</kml>

```

```

    <Snippet maxLines="0"> </Snippet>
    <description>LODGP2ZZ</description>
    <name>LODGP2ZZ</name>
    <Point>
      <coordinates>-0.17617027,51.200387,0</coordinates>
    </Point>
  </Placemark>
</Placemark>
<Placemark>
  <Snippet maxLines="0"> </Snippet>
  <description>LOWFP1ZZ</description>
  <name>LOWFP1ZZ</name>
  <Point>
    <coordinates>-0.17800193,51.146323,0</coordinates>
  </Point>
</Placemark>
</Placemark>
<Placemark>
  <Snippet maxLines="0"> </Snippet>
  <description>NAGSP3ZZ</description>
  <name>NAGSP3ZZ</name>
  <Point>
    <coordinates>-0.17325607,51.217967,0</coordinates>
  </Point>
</Placemark>
</Placemark>
<Placemark>
  <Snippet maxLines="0"> </Snippet>
  <description>SALFP2ZZ</description>
  <name>SALFP2ZZ</name>
  <Point>
    <coordinates>-0.16782942,51.204609,0</coordinates>
  </Point>
</Placemark>
</Placemark>
<Placemark>
  <Snippet maxLines="0"> </Snippet>
  <description>SUBRP3ZZ</description>
  <name>SUBRP3ZZ</name>
  <Point>
    <coordinates>-0.1549624,51.253966,0</coordinates>
  </Point>
</Placemark>
</Placemark>
<Placemark>
  <Snippet maxLines="0"> </Snippet>
  <description>TILGP1ZZ</description>
  <name>TILGP1ZZ</name>
  <Point>
    <coordinates>-0.1936723,51.093552,0</coordinates>
  </Point>
</Placemark>
</Document>
</kml>

```

### 9.15 Cluster 15

```

<?xml version="1.0" encoding="utf-8"?>
<kml xmlns="http://www.opengis.net/kml/2.2">
  <Document>
    <name>ClustArng15</name>
    <Placemark>

```

```
<Snippet maxLines="0"> </Snippet>
<description>BRAYP2ZZ</description>
<name>BRAYP2ZZ</name>
<Point>
  <coordinates>-0.48207562,51.551266,0</coordinates>
</Point>
</Placemark>
<Placemark>
  <Snippet maxLines="0"> </Snippet>
  <description>COLNP1ZZ</description>
  <name>COLNP1ZZ</name>
  <Point>
    <coordinates>-0.52719581,51.484571,0</coordinates>
  </Point>
</Placemark>
<Placemark>
  <Snippet maxLines="0"> </Snippet>
  <description>DOUGP2ZZ</description>
  <name>DOUGP2ZZ</name>
  <Point>
    <coordinates>-0.54990138,51.459811,0</coordinates>
  </Point>
</Placemark>
<Placemark>
  <Snippet maxLines="0"> </Snippet>
  <description>FRAYP1ZZ</description>
  <name>FRAYP1ZZ</name>
  <Point>
    <coordinates>-0.48344011,51.536689,0</coordinates>
  </Point>
</Placemark>
<Placemark>
  <Snippet maxLines="0"> </Snippet>
  <description>ROCHP1ZZ</description>
  <name>ROCHP1ZZ</name>
  <Point>
    <coordinates>-0.56990362,51.516176,0</coordinates>
  </Point>
</Placemark>
<Placemark>
  <Snippet maxLines="0"> </Snippet>
  <description>CHURP0ZZ</description>
  <name>CHURP0ZZ</name>
  <Point>
    <coordinates>-0.51977235,51.435371,0</coordinates>
  </Point>
</Placemark>
<Placemark>
  <Snippet maxLines="0"> </Snippet>
  <description>COWLP2ZZ</description>
  <name>COWLP2ZZ</name>
  <Point>
    <coordinates>-0.51003258,51.38936,0</coordinates>
  </Point>
</Placemark>
<Placemark>
  <Snippet maxLines="0"> </Snippet>
```

```
<description>DEVIP1ZZ</description>
<name>DEVIP1ZZ</name>
<Point>
  <coordinates>-0.52601941,51.423203,0</coordinates>
</Point>
</Placemark>
<Placemark>
  <Snippet maxLines="0"> </Snippet>
  <description>HAMHP1ZZ</description>
  <name>HAMHP1ZZ</name>
  <Point>
    <coordinates>-0.46094492,51.380102,0</coordinates>
  </Point>
</Placemark>
<Placemark>
  <Snippet maxLines="0"> </Snippet>
  <description>MOORP4ZZ</description>
  <name>MOORP4ZZ</name>
  <Point>
    <coordinates>-0.51946246,51.440952,0</coordinates>
  </Point>
</Placemark>
<Placemark>
  <Snippet maxLines="0"> </Snippet>
  <description>POYLP1ZZ</description>
  <name>POYLP1ZZ</name>
  <Point>
    <coordinates>-0.51509264,51.478079,0</coordinates>
  </Point>
</Placemark>
<Placemark>
  <Snippet maxLines="0"> </Snippet>
  <description>STAIP2ZZ</description>
  <name>STAIP2ZZ</name>
  <Point>
    <coordinates>-0.51371679,51.435331,0</coordinates>
  </Point>
</Placemark>
<Placemark>
  <Snippet maxLines="0"> </Snippet>
  <description>WATEP5ZZ</description>
  <name>WATEP5ZZ</name>
  <Point>
    <coordinates>-0.59232396,51.407787,0</coordinates>
  </Point>
</Placemark>
<Placemark>
  <Snippet maxLines="0"> </Snippet>
  <description>WHEAP7ZZ</description>
  <name>WHEAP7ZZ</name>
  <Point>
    <coordinates>-0.50586231,51.420753,0</coordinates>
  </Point>
</Placemark>
<Placemark>
  <Snippet maxLines="0"> </Snippet>
  <description>WICKP1ZZ</description>
```

```

    <name>WICKP1ZZ</name>
    <Point>
      <coordinates>-0.58994677,51.422433,0</coordinates>
    </Point>
  </Placemark>
<Placemark>
  <Snippet maxLines="0"> </Snippet>
  <description>YARDP2ZZ</description>
  <name>YARDP2ZZ</name>
  <Point>
    <coordinates>-0.54484016,51.439714,0</coordinates>
  </Point>
</Placemark>
</Document>
</kml>

```

## 9.16 Cluster 16

```

<?xml version="1.0" encoding="utf-8"?>
<kml xmlns="http://www.opengis.net/kml/2.2">
  <Document>
    <name>ClustArng16</name>
    <Placemark>
      <Snippet maxLines="0"> </Snippet>
      <description>ALDEP4ZZ</description>
      <name>ALDEP4ZZ</name>
      <Point>
        <coordinates>-1.1353531,51.40047,0</coordinates>
      </Point>
    </Placemark>
    <Placemark>
      <Snippet maxLines="0"> </Snippet>
      <description>ARROP1ZZ</description>
      <name>ARROP1ZZ</name>
      <Point>
        <coordinates>-1.0680501,51.43291,0</coordinates>
      </Point>
    </Placemark>
    <Placemark>
      <Snippet maxLines="0"> </Snippet>
      <description>BRADP1ZZ</description>
      <name>BRADP1ZZ</name>
      <Point>
        <coordinates>-1.1300183,51.451315,0</coordinates>
      </Point>
    </Placemark>
    <Placemark>
      <Snippet maxLines="0"> </Snippet>
      <description>BRADP3ZZ</description>
      <name>BRADP3ZZ</name>
      <Point>
        <coordinates>-1.1689796,51.43918,0</coordinates>
      </Point>
    </Placemark>
    <Placemark>
      <Snippet maxLines="0"> </Snippet>
      <description>BRAMP2ZZ</description>

```



```
<name>BRAMP2ZZ</name>
<Point>
  <coordinates>-1.0829783,51.328101,0</coordinates>
</Point>
</Placemark>
<Placemark>
  <Snippet maxLines="0"> </Snippet>
  <description>BUSIP1ZZ</description>
  <name>BUSIP1ZZ</name>
  <Point>
    <coordinates>-1.06378,51.434908,0</coordinates>
  </Point>
</Placemark>
<Placemark>
  <Snippet maxLines="0"> </Snippet>
  <description>COLLP5ZZ</description>
  <name>COLLP5ZZ</name>
  <Point>
    <coordinates>-1.1221122,51.320128,0</coordinates>
  </Point>
</Placemark>
<Placemark>
  <Snippet maxLines="0"> </Snippet>
  <description>ELIZP2ZZ</description>
  <name>ELIZP2ZZ</name>
  <Point>
    <coordinates>-1.0731754,51.436978,0</coordinates>
  </Point>
</Placemark>
<Placemark>
  <Snippet maxLines="0"> </Snippet>
  <description>FERRP1ZZ</description>
  <name>FERRP1ZZ</name>
  <Point>
    <coordinates>-1.1413662,51.520707,0</coordinates>
  </Point>
</Placemark>
<Placemark>
  <Snippet maxLines="0"> </Snippet>
  <description>HSTRP1ZZ</description>
  <name>HSTRP1ZZ</name>
  <Point>
    <coordinates>-1.1397534,51.522925,0</coordinates>
  </Point>
</Placemark>
<Placemark>
  <Snippet maxLines="0"> </Snippet>
  <description>SHOOP1ZZ</description>
  <name>SHOOP1ZZ</name>
  <Point>
    <coordinates>-1.0944631,51.487409,0</coordinates>
  </Point>
</Placemark>
<Placemark>
  <Snippet maxLines="0"> </Snippet>
  <description>SWAIP1ZZ</description>
  <name>SWAIP1ZZ</name>
```

```

    <Point>
      <coordinates>-1.1405855,51.349821,0</coordinates>
    </Point>
  </Placemark>
</Document>
</kml>

```

## 9.17 Cluster 17

```

<?xml version="1.0" encoding="utf-8"?>
<kml xmlns="http://www.opengis.net/kml/2.2">
  <Document>
    <name>ClustArng17</name>
    <Placemark>
      <Snippet maxLines="0"> </Snippet>
      <description>CHARPEZZ</description>
      <name>CHARPEZZ</name>
      <Point>
        <coordinates>-1.5123434,51.419072,0</coordinates>
      </Point>
    </Placemark>
    <Placemark>
      <Snippet maxLines="0"> </Snippet>
      <description>EDDIP1ZZ</description>
      <name>EDDIP1ZZ</name>
      <Point>
        <coordinates>-1.5093468,51.419572,0</coordinates>
      </Point>
    </Placemark>
    <Placemark>
      <Snippet maxLines="0"> </Snippet>
      <description>GBEDP1ZZ</description>
      <name>GBEDP1ZZ</name>
      <Point>
        <coordinates>-1.597699,51.379077,0</coordinates>
      </Point>
    </Placemark>
    <Placemark>
      <Snippet maxLines="0"> </Snippet>
      <description>GBEDP2ZZ</description>
      <name>GBEDP2ZZ</name>
      <Point>
        <coordinates>-1.5979095,51.381299,0</coordinates>
      </Point>
    </Placemark>
    <Placemark>
      <Snippet maxLines="0"> </Snippet>
      <description>RAMSP1ZZ</description>
      <name>RAMSP1ZZ</name>
      <Point>
        <coordinates>-1.592885,51.442335,0</coordinates>
      </Point>
    </Placemark>
    <Placemark>
      <Snippet maxLines="0"> </Snippet>
      <description>SMITP2ZZ</description>
      <name>SMITP2ZZ</name>

```

```

    <Point>
      <coordinates>-1.5256359,51.413057,0</coordinates>
    </Point>
  </Placemark>
</Placemark>
  <Snippet maxLines="0"> </Snippet>
  <description>TEMPP8ZZ</description>
  <name>TEMPP8ZZ</name>
  <Point>
    <coordinates>-1.4591772,51.399588,0</coordinates>
  </Point>
</Placemark>
</Placemark>
  <Snippet maxLines="0"> </Snippet>
  <description>WESTPGZZ</description>
  <name>WESTPGZZ</name>
  <Point>
    <coordinates>-1.4234075,51.460606,0</coordinates>
  </Point>
</Placemark>
</Document>
</kml>

```

## 9.18 Cluster 18

```

<?xml version="1.0" encoding="utf-8"?>
<kml xmlns="http://www.opengis.net/kml/2.2">
  <Document>
    <name>ClustArng18</name>
    <Placemark>
      <Snippet maxLines="0"> </Snippet>
      <description>BARFP1ZZ</description>
      <name>BARFP1ZZ</name>
      <Point>
        <coordinates>-1.3650707,51.991903,0</coordinates>
      </Point>
    </Placemark>
    <Placemark>
      <Snippet maxLines="0"> </Snippet>
      <description>CHAPP5ZZ</description>
      <name>CHAPP5ZZ</name>
      <Point>
        <coordinates>-1.314206,51.975281,0</coordinates>
      </Point>
    </Placemark>
    <Placemark>
      <Snippet maxLines="0"> </Snippet>
      <description>CLEVP1ZZ</description>
      <name>CLEVP1ZZ</name>
      <Point>
        <coordinates>-1.4315331,51.91181,0</coordinates>
      </Point>
    </Placemark>
    <Placemark>
      <Snippet maxLines="0"> </Snippet>
      <description>CLEVP2ZZ</description>
      <name>CLEVP2ZZ</name>

```

```

    <Point>
      <coordinates>-1.4365083,51.913865,0</coordinates>
    </Point>
  </Placemark>
<Placemark>
  <Snippet maxLines="0"> </Snippet>
  <description>LTADP1ZZ</description>
  <name>LTADP1ZZ</name>
  <Point>
    <coordinates>-1.4086726,52.032948,0</coordinates>
  </Point>
</Placemark>
<Placemark>
  <Snippet maxLines="0"> </Snippet>
  <description>SANDP1ZZ</description>
  <name>SANDP1ZZ</name>
  <Point>
    <coordinates>-1.3928873,51.935865,0</coordinates>
  </Point>
</Placemark>
<Placemark>
  <Snippet maxLines="0"> </Snippet>
  <description>SNEWP1ZZ</description>
  <name>SNEWP1ZZ</name>
  <Point>
    <coordinates>-1.4076677,51.998661,0</coordinates>
  </Point>
</Placemark>
</Document>
</kml>

```

## 9.19 Cluster 19

```

<?xml version="1.0" encoding="utf-8"?>
<kml xmlns="http://www.opengis.net/kml/2.2">
  <Document>
    <name>ClustArng19</name>
    <Placemark>
      <Snippet maxLines="0"> </Snippet>
      <description>ANDOP1ZZ</description>
      <name>ANDOP1ZZ</name>
      <Point>
        <coordinates>-1.9658036,51.87474,0</coordinates>
      </Point>
    </Placemark>
    <Placemark>
      <Snippet maxLines="0"> </Snippet>
      <description>COLNP2ZZ</description>
      <name>COLNP2ZZ</name>
      <Point>
        <coordinates>-1.7891026,51.743414,0</coordinates>
      </Point>
    </Placemark>
    <Placemark>
      <Snippet maxLines="0"> </Snippet>
      <description>DUNSP3ZZ</description>
      <name>DUNSP3ZZ</name>

```

```

    <Point>
      <coordinates>-1.80067,51.553116,0</coordinates>
    </Point>
  </Placemark>
<Placemark>
  <Snippet maxLines="0"> </Snippet>
  <description>GREEP6ZZ</description>
  <name>GREEP6ZZ</name>
  <Point>
    <coordinates>-1.8390867,51.70208,0</coordinates>
  </Point>
</Placemark>
<Placemark>
  <Snippet maxLines="0"> </Snippet>
  <description>LECHP1ZZ</description>
  <name>LECHP1ZZ</name>
  <Point>
    <coordinates>-1.6968861,51.693599,0</coordinates>
  </Point>
</Placemark>
<Placemark>
  <Snippet maxLines="0"> </Snippet>
  <description>MALVP1ZZ</description>
  <name>MALVP1ZZ</name>
  <Point>
    <coordinates>-1.7814047,51.57342,0</coordinates>
  </Point>
</Placemark>
<Placemark>
  <Snippet maxLines="0"> </Snippet>
  <description>REDLP1ZZ</description>
  <name>REDLP1ZZ</name>
  <Point>
    <coordinates>-1.9271559,51.663865,0</coordinates>
  </Point>
</Placemark>
</Document>
</kml>

```

## 9.20 Cluster 20

```

<?xml version="1.0" encoding="utf-8"?>
<kml xmlns="http://www.opengis.net/kml/2.2">
  <Document>
    <name>ClustArng20</name>
    <Placemark>
      <Snippet maxLines="0"> </Snippet>
      <description>CHURP2ZZ</description>
      <name>CHURP2ZZ</name>
      <Point>
        <coordinates>-1.5922899,51.9119,0</coordinates>
      </Point>
    </Placemark>
    <Placemark>
      <Snippet maxLines="0"> </Snippet>
      <description>CHURP1ZZ</description>
      <name>CHURP1ZZ</name>

```

```
<Point>
  <coordinates>-1.6023248,51.92133,0</coordinates>
</Point>
</Placemark>
<Placemark>
  <Snippet maxLines="0"> </Snippet>
  <description>KINGP4ZZ</description>
  <name>KINGP4ZZ</name>
  <Point>
    <coordinates>-1.6254965,51.908091,0</coordinates>
  </Point>
</Placemark>
<Placemark>
  <Snippet maxLines="0"> </Snippet>
  <description>MILTP2ZZ</description>
  <name>MILTP2ZZ</name>
  <Point>
    <coordinates>-1.6170957,51.865159,0</coordinates>
  </Point>
</Placemark>
<Placemark>
  <Snippet maxLines="0"> </Snippet>
  <description>MILTP3ZZ</description>
  <name>MILTP3ZZ</name>
  <Point>
    <coordinates>-1.6067612,51.861187,0</coordinates>
  </Point>
</Placemark>
<Placemark>
  <Snippet maxLines="0"> </Snippet>
  <description>NAUNP1ZZ</description>
  <name>NAUNP1ZZ</name>
  <Point>
    <coordinates>-1.8247841,51.909706,0</coordinates>
  </Point>
</Placemark>
<Placemark>
  <Snippet maxLines="0"> </Snippet>
  <description>SALFP3ZZ</description>
  <name>SALFP3ZZ</name>
  <Point>
    <coordinates>-1.5780085,51.946609,0</coordinates>
  </Point>
</Placemark>
<Placemark>
  <Snippet maxLines="0"> </Snippet>
  <description>SHIPP2ZZ</description>
  <name>SHIPP2ZZ</name>
  <Point>
    <coordinates>-1.5953584,51.861589,0</coordinates>
  </Point>
</Placemark>
<Placemark>
  <Snippet maxLines="0"> </Snippet>
  <description>USLAP1ZZ</description>
  <name>USLAP1ZZ</name>
  <Point>
```

```
      <coordinates>-1.7734768,51.908117,0</coordinates>  
    </Point>  
  </Placemark>  
</Document>  
</kml>
```

**Optimisation of Water Companies Waste  
Pumping Asset Base with a Focus on Energy  
Reduction**

**Appendix 2 – Topographical Survey of Cover  
Levels at 33 Sites**

**Alex Gray**

**2022**

*College of Engineering, Design and Physical  
Sciences Brunel University London*



## List of Figures

Figure 1 Apollo Drive APOLP1ZZ .....	221
Figure 2 Hamilton Close HAMIP1ZZ .....	222
Figure 3 Headley Mill HEADP1ZZ .....	223
Figure 4 Monument Close MONUP0ZZ .....	224
Figure 5 Walldown Road WALLP1ZZ .....	225
Figure 6 Bordon STW (Canes Lane) BORDS1ZZ .....	226
Figure 7 Hogmoor Road HOGMP2ZZ .....	227
Figure 8 Arford ARFOP1ZZ .....	228
Figure 9 Ashgrove ASHGP1ZZ .....	229
Figure 10 Tunbridge Lane TUNBP1ZZ .....	230
Figure 11 Oakhanger OAKHP1ZZ .....	231
Figure 12 Chapel Gardens CHAPP1ZZ .....	232
Figure 13 The Meadows MEADP8ZZ .....	233
Figure 14 Churt CHURP7ZZ .....	234
Figure 15 Conford Passfield CONFP1ZZ .....	235
Figure 16 Bramshott Court BRAMP8ZZ .....	236
Figure 17 Cypress CYPRP1ZZ .....	237
Figure 18 Griggs Green GRIGP2ZZ .....	238
Figure 19 Whitmore Vale WHITPDZZ .....	239
Figure 20 Stoney Bottom STONP8ZZ .....	240
Figure 21 Heatherlands (Headley Down) HEATP8ZZ .....	241
Figure 22 Larch Close LARCP3ZZ .....	242
Figure 23 Marsh Close MARSP5ZZ .....	243
Figure 24 Chalet Hill CHALP2ZZ .....	244
Figure 25 Maple Leaf Drive MAPLP0ZZ .....	245
Figure 26 Woolmer WOOLP2ZZ .....	246
Figure 27 Tulls Hill TULLP1ZZ .....	247
Figure 28 Malthouse Meadow MALTP3ZZ .....	248
Figure 29 Warren Close P2ZZ .....	249
Figure 30 Kingsley Common KINGP1ZZ .....	250
Figure 31 Lionfield LIONP2ZZ .....	251
Figure 32 Western WESTPAZZ .....	252
Figure 33 Passfield PASSP1ZZ .....	253

select surveys 



**Project Title:**

Topographical Survey of Cover Levels

**Location:**

Borden, Hampshire

**Date:** 31/3/2017

**Site Name:** Apollo Drive APOLP1ZZ

**Elevation [m]:** 72.56

**Surveyor:** Cyprian Luzarowski

**Checked by:** Martin Bramwell

**Additional information:** Nearest reference used - CL=72.86. Second manhole not located.



**Figure 61 Apollo Drive APOLP1ZZ**

select surveys 



Project Title:

Topographical Survey of Cover Levels

Location:

Borden, Hampshire

Date: 31/3/2017

Site Name: Hamilton Close HAMIP1ZZ

Elevation [m]: 72.42



Surveyor: Cyprian Luzarowski

Checked by: Martin Bramwell

Additional information: Nearest reference used - CL=72.10



Figure 62 Hamilton Close HAMIP1ZZ

		
<b>Project Title:</b> Topographical Survey of Cover Levels	<b>Location:</b> Borden, Hampshire	<b>Date:</b> 31/3/2017
<b>Site Name:</b> Headley Mill HEADP1ZZ		
<b>Elevation [m]:</b> 72.04		
<b>Surveyor:</b> Cyprian Luzarowski	<b>Checked by:</b> Martin Bramwell	
<b>Additional information:</b> Nearest reference used - 71.45. Second manhole not located.		
		

**Figure 5 Headley Mill HEADP1ZZ**









select surveys 		
<b>Project Title:</b> Topographical Survey of Cover Levels	<b>Location:</b> Borden, Hampshire	<b>Date:</b> 31/3/2017
<b>Site Name:</b> Monument Chase MONUP0ZZ		
<b>Elevation [m]:</b> 75.98		
<b>Surveyor:</b> Cyprian Luzarowski	<b>Checked by:</b> Martin Bramwell	
<b>Additional information:</b> Nearest reference used - 76.92		
		

Figure 6 Monument Close MONUP0ZZ

		
<b>Project Title:</b> Topographical Survey of Cover Levels	<b>Location:</b> Borden, Hampshire	<b>Date:</b> 31/3/2017
<b>Site Name:</b> Walldown Road WALLP1ZZ		
<b>Elevation [m]:</b> 73.741		
<b>Surveyor:</b> Cyprian Luzarowski	<b>Checked by:</b> Martin Bramwell	
<b>Additional information:</b> Nearest reference used - 73.726		
		

**Figure 7 Walldown Road WALLP1ZZ**

		
<b>Project Title:</b> Topographical Survey of Cover Levels	<b>Location:</b> Borden, Hampshire	<b>Date:</b> 31/3/2017
<b>Site Name:</b> Bordon STW Canes Lane		
<b>Elevation [m]:</b> 68.82		
<b>Surveyor:</b> Cyprian Luzarowski	<b>Checked by:</b> Martin Bramwell	
<b>Additional information:</b> Nearest reference used - 68.28. Second manhole not available.		
		

**Figure 66 Bordon STW (Canes Lane) BORDS1ZZ**

select surveys 



**Project Title:**

Topographical Survey of Cover Levels

**Location:**

Borden, Hampshire

**Date:** 31/3/2017

**Site Name:** Hogmoor Road HOGMP2ZZ

**Elevation [m]:** 84.64

**Surveyor:** Cyprian Luzarowski

**Checked by:** Martin Bramwell

**Additional information:** Nearest reference used - 84.65 (closer one to marked yellow dot)



**Figure 67 Hogmoor Road HOGMP2ZZ**



select surveys 



Project Title:

Topographical Survey of Cover Levels

Location:

Borden, Hampshire

Date: 31/3/2017

Site Name: Arford ARFOP1ZZ

Elevation [m]: 75.36

Surveyor: Cyprian Luzarowski

Checked by: Martin Bramwell

Additional information: Nearest reference used - 75.64 (cover closer to the gate)

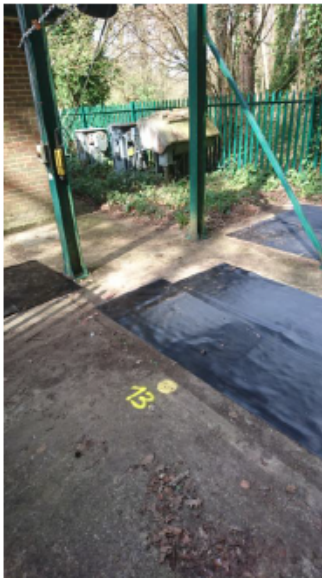

Figure 68 Arford ARFOP1ZZ

select surveys 



**Project Title:**

Topographical Survey of Cover Levels

**Location:**

Borden, Hampshire

**Date:** 31/3/2017

**Site Name:** Ashgrove ASHGP1ZZ

**Elevation [m]:** 116.51

**Surveyor:** Cyprian Luzarowski

**Checked by:** Martin Bramwell

**Additional information:** Nearest reference used - 118.41



**Figure 69 Ashgrove ASHGP1ZZ**

select surveys 



**Project Title:**

Topographical Survey of Cover Levels

**Location:**

Borden, Hampshire

**Date:** 31/3/2017

**Site Name:** Tunbridge Lane

**Elevation [m]:** Cover No 16 - 92.67      Cover No 16A - 92.54



**Surveyor:** Cyprian Luzarowski

**Checked by:** Martin Bramwell



**Additional information:** Nearest reference used - 92.35





**Figure 70 Tunbridge Lane TUNBP1ZZ**

			
<b>Project Title:</b> Topographical Survey of Cover Levels		<b>Location:</b> Borden, Hampshire	
<b>Date:</b> 31/3/2017			
<b>Site Name:</b> Oakhanger OAKHP1ZZ			
<b>Elevation [m]:</b> 71.85			
<b>Surveyor:</b> Cyprian Luzarowski		<b>Checked by:</b> Martin Bramwell	
<b>Additional information:</b> Nearest reference used - 72.07. Second manhole not located.			
			

**Figure 71 Oakhanger OAKHP1ZZ**

		
<b>Project Title:</b> Topographical Survey of Cover Levels	<b>Location:</b> Borden, Hampshire	<b>Date:</b> 31/3/2017
<b>Site Name:</b> Chapel Gardens CHAPP1ZZ		
<b>Elevation [m]:</b> 67.37		
<b>Surveyor:</b> Cyprian Luzarowski	<b>Checked by:</b> Martin Bramwell	
<b>Additional information:</b> Nearest reference used - 68.43, 68.51		
		

**Figure 72 Chapel Gardens CHAPP1ZZ**

		
<b>Project Title:</b> Topographical Survey of Cover Levels	<b>Location:</b> Borden, Hampshire	<b>Date:</b> 31/3/2017
<b>Site Name:</b> The Meadows MEADP8ZZ		
<b>Elevation [m]:</b> 106.92		
<b>Surveyor:</b> Cyprian Luzarowski	<b>Checked by:</b> Martin Bramwell	
<b>Additional information:</b> Nearest reference used -107.76. Second manhole not located.		
		

**Figure 73 The Meadows MEADP8ZZ**



select surveys 



<b>Project Title:</b> Topographical Survey of Cover Levels	<b>Location:</b> Borden, Hampshire	<b>Date:</b> 31/3/2017
<b>Site Name:</b> Churt CHURP7ZZ		
<b>Elevation [m]:</b> 90.14		
<b>Surveyor:</b> Cyprian Luzarowski	<b>Checked by:</b> Martin Bramwell	
<b>Additional information:</b> Nearest reference used - 89.33		







Figure 74 Churt CHURP7ZZ

			
<b>Project Title:</b> Topographical Survey of Cover Levels		<b>Location:</b> Borden, Hampshire	
		<b>Date:</b> 31/3/2017	
<b>Site Name:</b> Conford Passfield CONF1ZZ			
<b>Elevation [m]:</b> 79.11			
<b>Surveyor:</b> Cyprian Luzarowski		<b>Checked by:</b> Martin Bramwell	
<b>Additional information:</b> Nearest reference used - 83.73			
			

**Figure 75 Conford Passfield CONF1ZZ**



		
<b>Project Title:</b> Topographical Survey of Cover Levels	<b>Location:</b> Borden, Hampshire	<b>Date:</b> 31/3/2017
<b>Site Name:</b> Bramshott Court BRAMP8ZZ		
<b>Elevation [m]:</b> 87.311		
<b>Surveyor:</b> Cyprian Luzarowski	<b>Checked by:</b> Martin Bramwell	
<b>Additional information:</b> Nearest reference used - 89.206		
<div style="display: flex; justify-content: space-around;">   </div>		

**Figure 76 Bramshott Court BRAMP8ZZ**



		
<b>Project Title:</b> Topographical Survey of Cover Levels	<b>Location:</b> Borden, Hampshire	<b>Date:</b> 31/3/2017
<b>Site Name:</b> Cypress CYPRP1ZZ		
<b>Elevation [m]:</b> 80.94		
<b>Surveyor:</b> Cyprian Luzarowski	<b>Checked by:</b> Martin Bramwell	
<b>Additional information:</b> Nearest reference used - 80.92		
		

Figure 77 Cypress CYPRP1ZZ

select surveys 



<b>Project Title:</b> Topographical Survey of Cover Levels	<b>Location:</b> Borden, Hampshire	<b>Date:</b> 31/3/2017
<b>Site Name:</b> Griggs Green GRIGP2ZZ		
<b>Elevation [m]:</b> 83.57		
<b>Surveyor:</b> Cyprian Luzarowski	<b>Checked by:</b> Martin Bramwell	
<b>Additional information:</b> Nearest reference used - 83.30. Second manhole not located.		



Figure 78 Griggs Green GRIGP2ZZ





select surveys 



<b>Project Title:</b> Topographical Survey of Cover Levels	<b>Location:</b> Borden, Hampshire	<b>Date:</b> 31/3/2017
<b>Site Name:</b> Whitmore Vale WHITPDZZ		
<b>Elevation [m]:</b> 172.15		
<b>Surveyor:</b> Cyprian Luzarowski	<b>Checked by:</b> Martin Bramwell	
<b>Additional information:</b> Nearest reference used - 195.55		



**Figure 79 Whitmore Vale WHITPDZZ**

select surveys 		
<b>Project Title:</b> Topographical Survey of Cover Levels	<b>Location:</b> Borden, Hampshire	<b>Date:</b> 31/3/2017
<b>Site Name:</b> Stoney Bottom		
<b>Elevation [m]:</b> 151.50		
<b>Surveyor:</b> Cyprian Luzarowski	<b>Checked by:</b> Martin Bramwell	
<b>Additional information:</b> Nearest reference used - 165.92. Second manhole not located		
<div style="display: flex; justify-content: space-around;">   </div>		

**Figure 80 Stoney Bottom STONP8ZZ**



			
<b>Project Title:</b> Topographical Survey of Cover Levels		<b>Location:</b> Borden, Hampshire	
<b>Date:</b> 31/3/2017			
<b>Site Name:</b> Maple Way HEATP8ZZ			
<b>Elevation [m]:</b> 127.47			
<b>Surveyor:</b> Cyprian Luzarowski		<b>Checked by:</b> Martin Bramwell	
<b>Additional information:</b> Nearest reference used - 128.72. Second manhole not available.			
			

Figure 81 Heatherlands (Headley Down) HEATP8ZZ







			
<b>Project Title:</b> Topographical Survey of Cover Levels		<b>Location:</b> Borden, Hampshire	
<b>Date:</b> 03/4/2017			
<b>Site Name:</b> Larch Close LARCP3ZZ			
<b>Elevation [m]:</b> 104.815			
<b>Surveyor:</b> Cyprian Luzarowski		<b>Checked by:</b> Martin Bramwell	
<b>Additional information:</b> Nearest reference used -104.739. Second manhole not located			
			

Figure 82 Larch Close LARCP3ZZ

			
<b>Project Title:</b> Topographical Survey of Cover Levels		<b>Location:</b> Borden, Hampshire	
<b>Date:</b> 03/4/2017			
<b>Site Name:</b> Marsh Close MARSP5ZZ			
<b>Elevation [m]:</b> 70.46			
<b>Surveyor:</b> Cyprian Luzarowski		<b>Checked by:</b> Martin Bramwell	
<b>Additional information:</b> Nearest reference used -71.45. Second manhole not located.			
			

**Figure 83 Marsh Close MARSP5ZZ**









		
<b>Project Title:</b> Topographical Survey of Cover Levels	<b>Location:</b> Borden, Hampshire	<b>Date:</b> 03/4/2017
<b>Site Name:</b> Chalet Hill CHALP2ZZ		
<b>Elevation [m]:</b> 69.439		
<b>Surveyor:</b> Cyprian Luzarowski	<b>Checked by:</b> Martin Bramwell	
<b>Additional information:</b> Nearest reference used - 68.761		
		

Figure 84 Chalet Hill CHALP2ZZ

			
<b>Project Title:</b> Topographical Survey of Cover Levels		<b>Location:</b> Borden, Hampshire	
		<b>Date:</b> 03/4/2017	
<b>Site Name:</b> Maple Leaf Drive MAPLP0ZZ			
<b>Elevation [m]:</b> Cover No 6 - 84.09    Cover No 6A - 83.86			
<b>Surveyor:</b> Cyprian Luzarowski		<b>Checked by:</b> Martin Bramwell	
<b>Additional information:</b> Nearest reference used - 85.34			
			

**Figure 85 Maple Leaf Drive MAPLP0ZZ**



select surveys 		
<b>Project Title:</b> Topographical Survey of Cover Levels	<b>Location:</b> Borden, Hampshire	<b>Date:</b> 03/4/2017
<b>Site Name:</b> Woolmer WOOLP2ZZ		
<b>Elevation [m]:</b> 80.16		
<b>Surveyor:</b> Cyprian Luzarowski	<b>Checked by:</b> Martin Bramwell	
<b>Additional information:</b> Nearest reference used - 80.15		
		

Figure 86 Woolmer WOOLP2ZZ







		
<b>Project Title:</b> Topographical Survey of Cover Levels	<b>Location:</b> Borden, Hampshire	<b>Date:</b> 03/4/2017
<b>Site Name:</b> Tulls Hill TULLP1ZZ		
<b>Elevation [m]:</b> 77.49		
<b>Surveyor:</b> Cyprian Luzarowski	<b>Checked by:</b> Martin Bramwell	
<b>Additional information:</b> Nearest reference used - 77.16. Second manhole not located.		
		

Figure 87 Tulls Hill TULLP1ZZ

		
<b>Project Title:</b> Topographical Survey of Cover Levels	<b>Location:</b> Borden, Hampshire	<b>Date:</b> 03/4/2017
<b>Site Name:</b> Malthouse Meadow MALTP3ZZ		
<b>Elevation [m]:</b> 95.16		
<b>Surveyor:</b> Cyprian Luzarowski	<b>Checked by:</b> Martin Bramwell	
<b>Additional information:</b> Nearest reference used - 102.87		
		

**Figure 88 Malthouse Meadow MALTP3ZZ**











		
<b>Project Title:</b> Topographical Survey of Cover Levels	<b>Location:</b> Borden, Hampshire	<b>Date:</b> 10/4/2017
<b>Site Name:</b> Warren Close WARRP2ZZ		
<b>Elevation [m]:</b> 79.48		
<b>Surveyor:</b> Cyprian Luzarowski	<b>Checked by:</b> Martin Bramwell	
<b>Additional information:</b> Nearest reference used - 79.88		
		

Figure 89 Warren Close P2ZZ

			
<b>Project Title:</b> Topographical Survey of Cover Levels		<b>Location:</b> Borden, Hampshire	
		<b>Date:</b> 03/4/2017	
<b>Site Name:</b> Kingsley Common KINGP1ZZ			
<b>Elevation [m]:</b> 71.14			
<b>Surveyor:</b> Cyprian Luzarowski		<b>Checked by:</b> Martin Bramwell	
<b>Additional information:</b> Nearest reference used - 71.12. Second manhole not located.			
<div style="display: flex; justify-content: space-around;">   </div>			

**Figure 90 Kingsley Common KINGP1ZZ**

			
<b>Project Title:</b> Topographical Survey of Cover Levels		<b>Location:</b> Borden, Hampshire	
<b>Date:</b> 10/4/2017			
<b>Site Name:</b> Lionfield LIONP2ZZ			
<b>Elevation [m]:</b> Cover No 29 - 78.83    Cover No A - 78.81			
<b>Surveyor:</b> Cyprian Luzarowski		<b>Checked by:</b> Martin Bramwell	
<b>Additional information:</b> Nearest reference used - 80.75			
			

**Figure 91 Lionfield LIONP2ZZ**



select surveys 



Project Title:

Topographical Survey of Cover Levels

Location:

Borden, Hampshire

Date: 10/4/2017

Site Name: Western WESTPAZZ

Elevation [m]: Cover No 18 - 73.95 Cover No A - 73.95



Surveyor: Cyprian Luzarowski

Checked by: Martin Bramwell

Additional information: Nearest reference used - 75.47. Second manhole not located.



Figure 92 Western WESTPAZZ

		
<b>Project Title:</b> Topographical Survey of Cover Levels	<b>Location:</b> Borden, Hampshire	<b>Date:</b> 10/4/2017
<b>Site Name:</b> Passfield PASSP1ZZ		
<b>Elevation [m]:</b> 86.26 (GPS)		
<b>Surveyor:</b> Cyprian Luzarowski	<b>Checked by:</b> Martin Bramwell	
<b>Additional information:</b> Nearest reference not located. Cover measured by GPS.		
Horizontal precision: 0.012m Vertical precision: 0.022m Satellites: 12 PDOP: 1.6 VDOP: 1.3 Position used: 180		
		

**Figure 93 Passfield PASSP1ZZ**

**Optimisation of Water Companies Waste  
Pumping Asset Base with a Focus on Energy  
Reduction**

**Appendix 3 – Manufacturers Pump Curve Data  
Sheets**

**Alex Gray**

**2022**

*College of Engineering, Design and Physical  
Sciences Brunel University London*

## List of Figures

Figure 1 Flygt n-3085 1450rpm Efficiency Curves .....	256
Figure 2 Flygt n-3085 1450rpm .....	257
Figure 3 Flygt n-3085 1415rpm .....	258
Figure 4 Flygt n-3102 efficiency curves .....	259
Figure 5 Flygt n-3102 1500rpm .....	260
Figure 6 Flygt n-3127 1460rpm efficiency curves .....	261
Figure 7 Flygt n-3127 1460rpm .....	262
Figure 8 Flygt n-3127 2900rpm efficiency curves .....	263
Figure 9 Flygt n-3127 2900rpm .....	264
Figure 10 Flygt n-3153 1500rpm efficiency curves .....	265
Figure 11 Flygt n-3153 1500rpm .....	266
Figure 12 Flygt n-3153-2900rpm efficiency curves .....	267
Figure 13 Flygt n-3153 2900rpm .....	268
Figure 14 Flygt n-3171 1460rpm .....	269
Figure 15 Flygt n-3202 1475rpm efficiency curves .....	270
Figure 16 Flygt n-3202 1475rpm .....	271
Figure 17 Flygt n-3231 .....	272

All figures within this appendix have been taken from the Xylem Water Inc archives. Xylem Water acquired Flygt pumps and now control all documentation archives. (Xylem Inc, 2017)

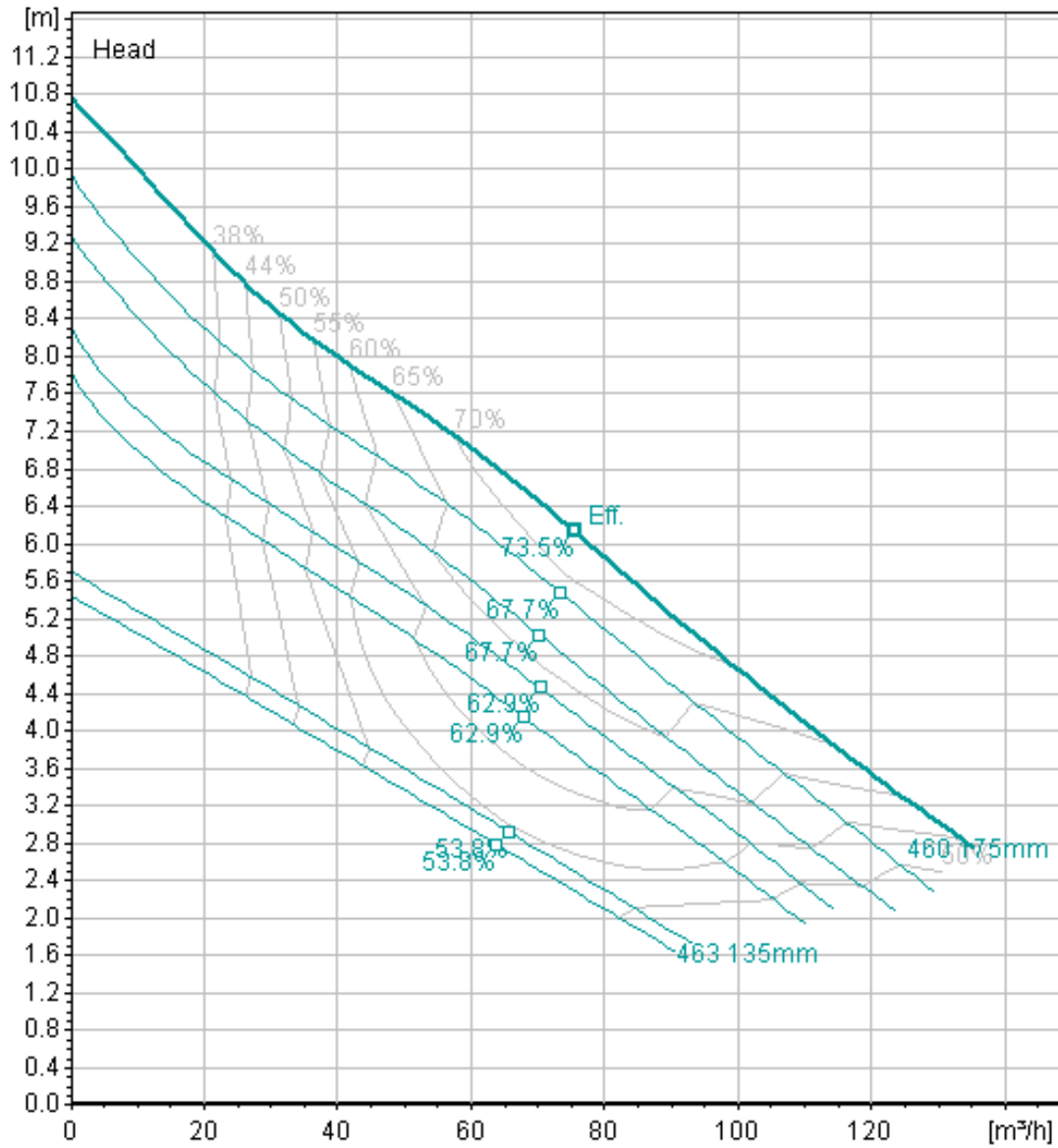

**Figure 36 Flygt n-3085 1450rpm Efficiency Curves**

Full details:

n-3085-mt-3-phase--4-poles-smartrun-50hz-metric-freq-50-measure-metric 1450rpm efficiency curves

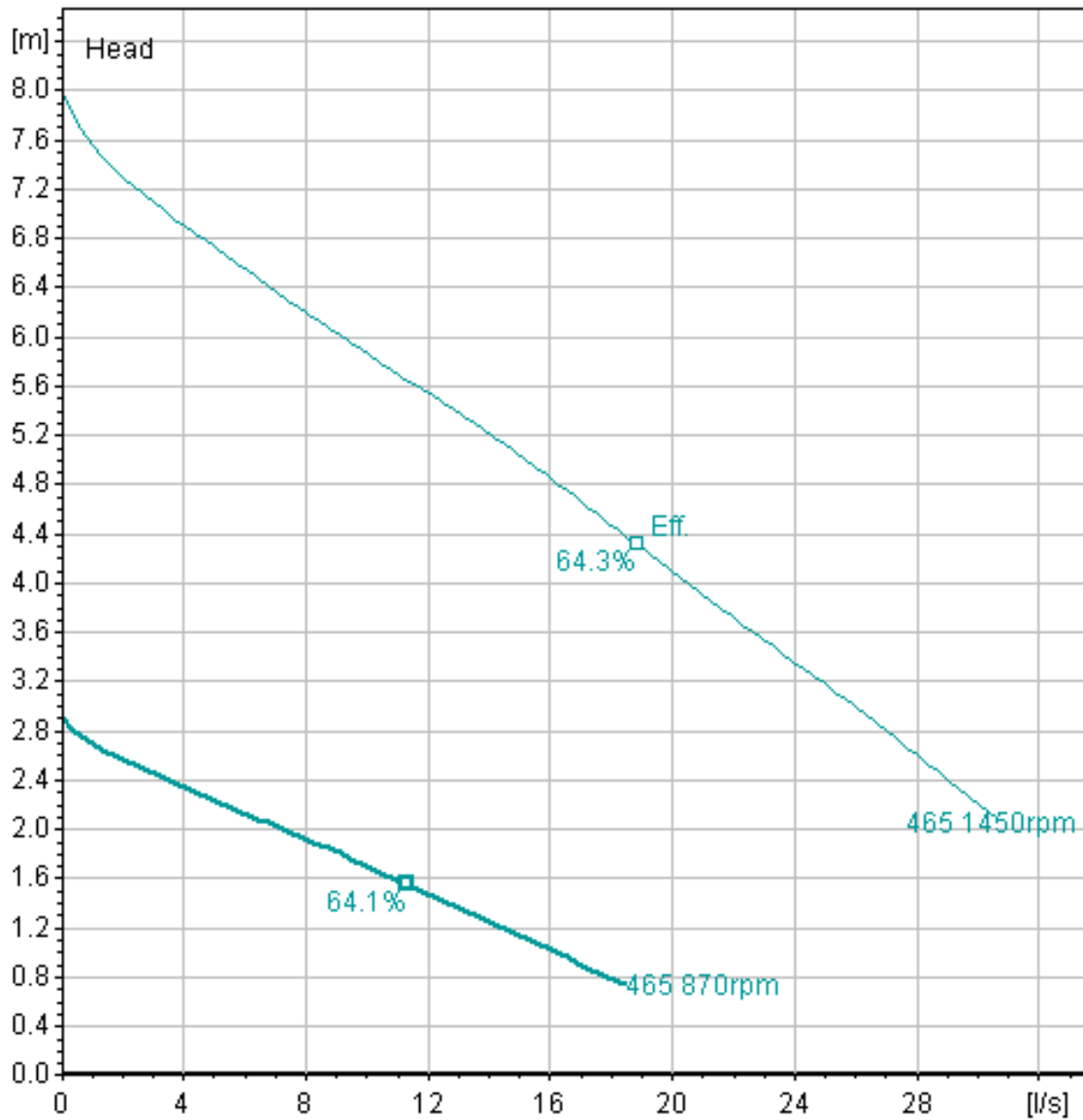

**Figure 37 Flygt n-3085 1450rpm**

Full details:

n-3085-mt-3-phase--4-poles-smartrun-50hz-metric-freq-50-measure-metric 1450rpm

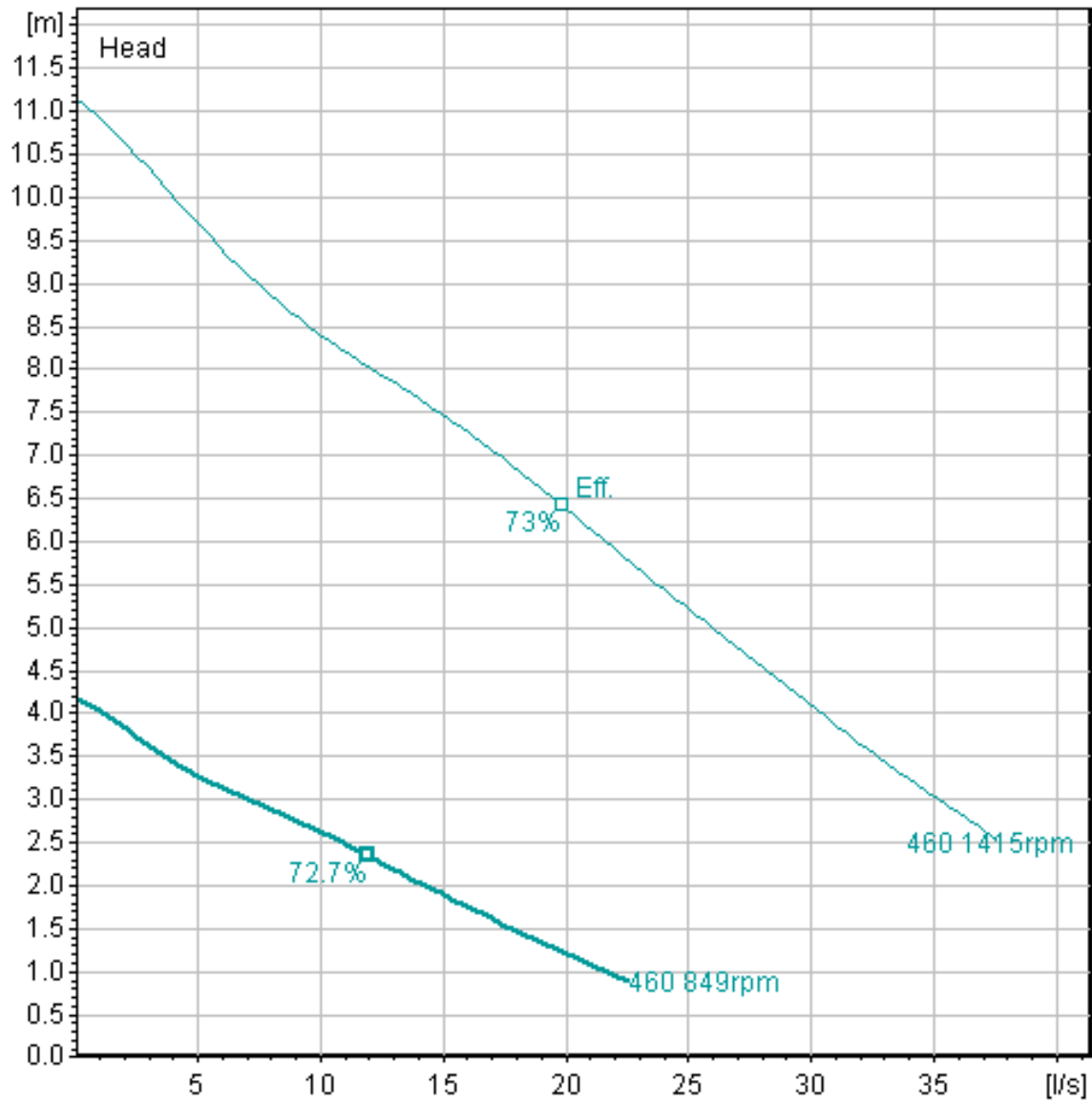

**Figure 38 Flygt n-3085 1415rpm**

Full details:

n-3085-mt-3-phase--adaptive-4-poles-smartrun-50hz-metric-freq-50-measure-metric 1415rpm

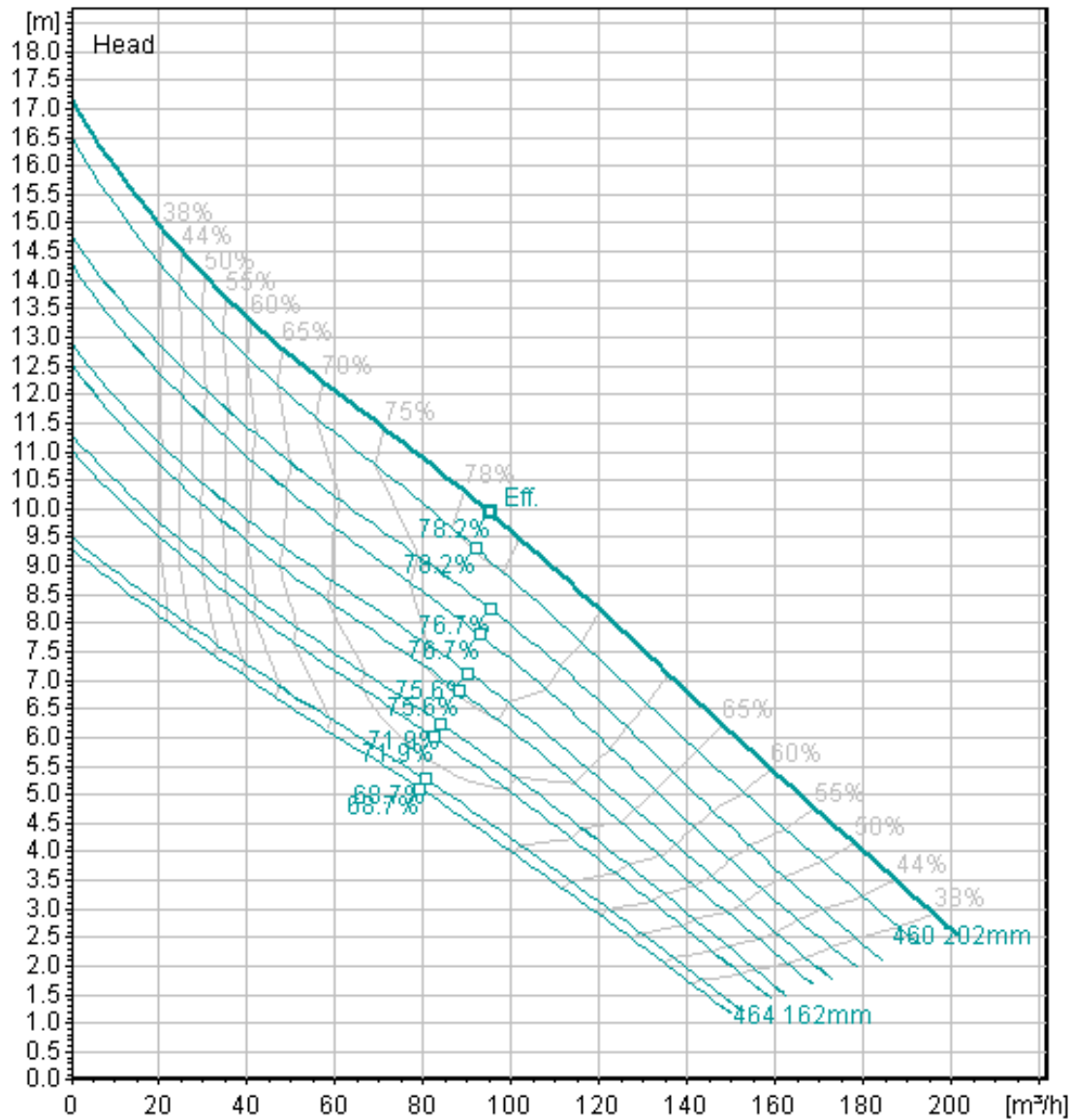
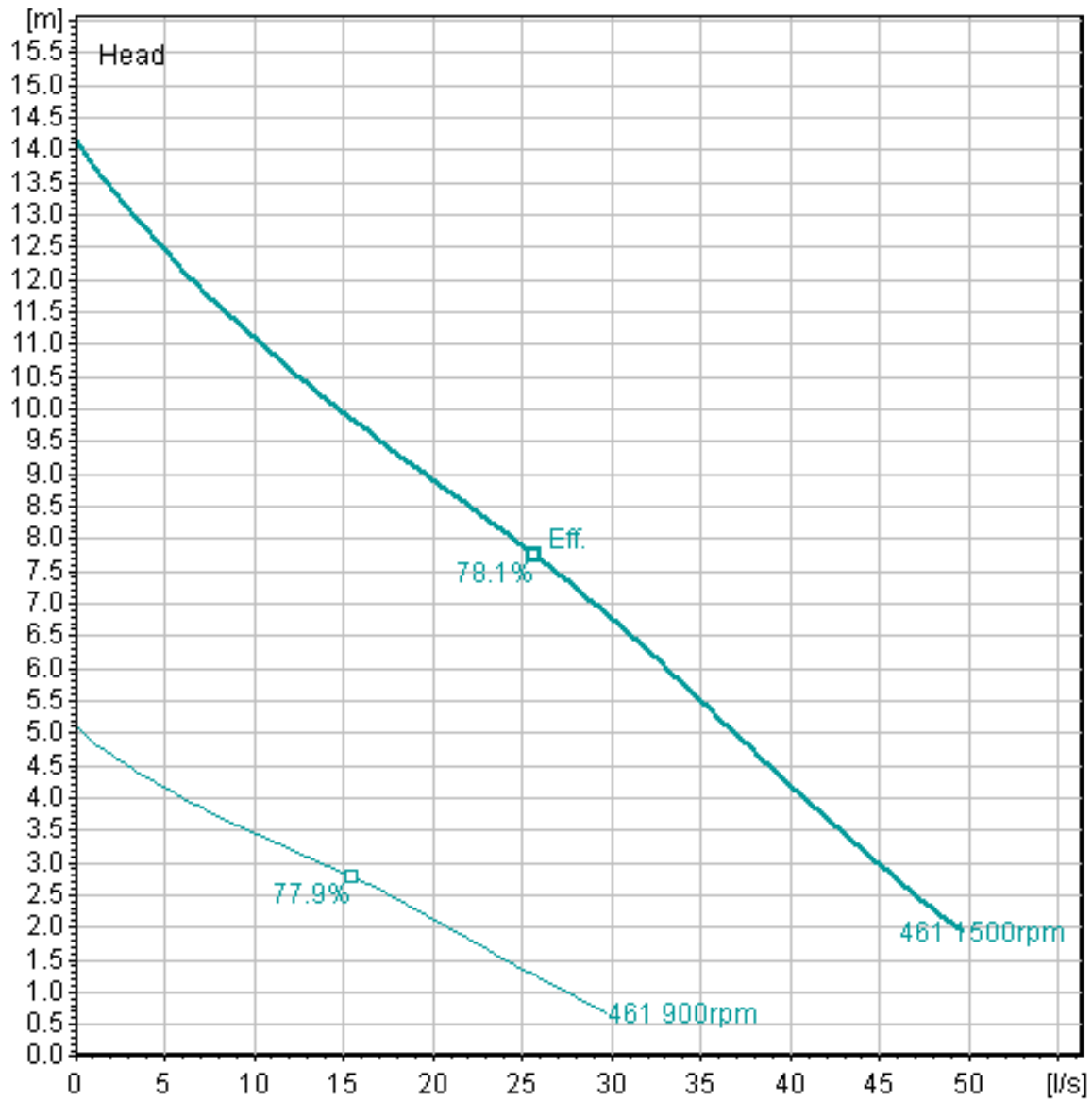

**Figure 39 Flygt n-3102 efficiency curves**

Full details:

n-3102-mt-3-phase--adaptive-4-poles-smartrun-50hz-metric-freq-50-measure-metric efficiency curves

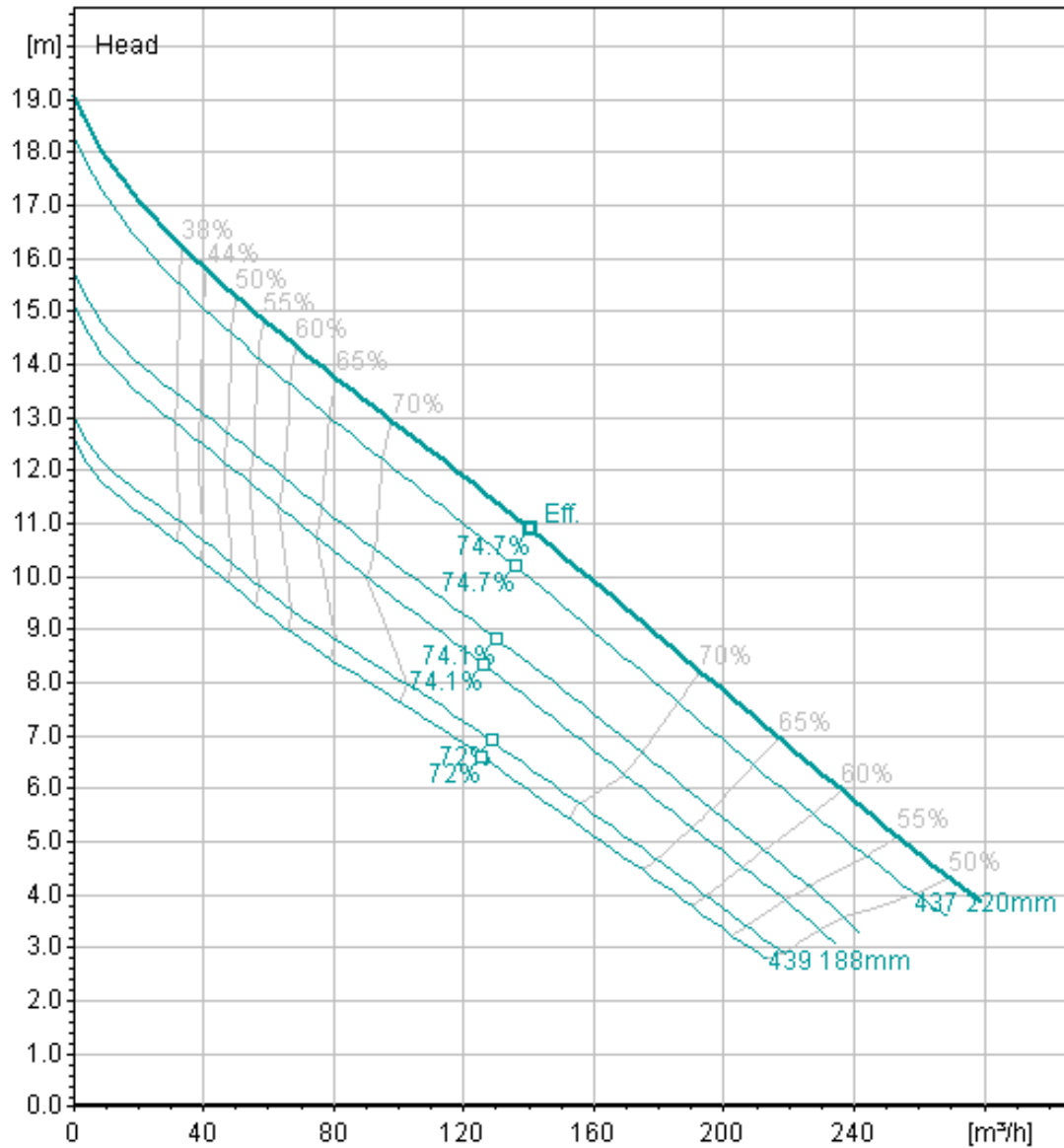



**Figure 40 Flygt n-3102 1500rpm**

Full details:

n-3102-mt-3-phase--adaptive-4-poles-smartrun-50hz-metric-freq-50-measure-metric 1500rpm



**Figure 41 Flygt n-3127 1460rpm efficiency curves**

Full details:

n-3127-mt-3-phase--4-poles-smartrun-50hz-metric-freq-50-measure-metric 1460rpm efficiency curves

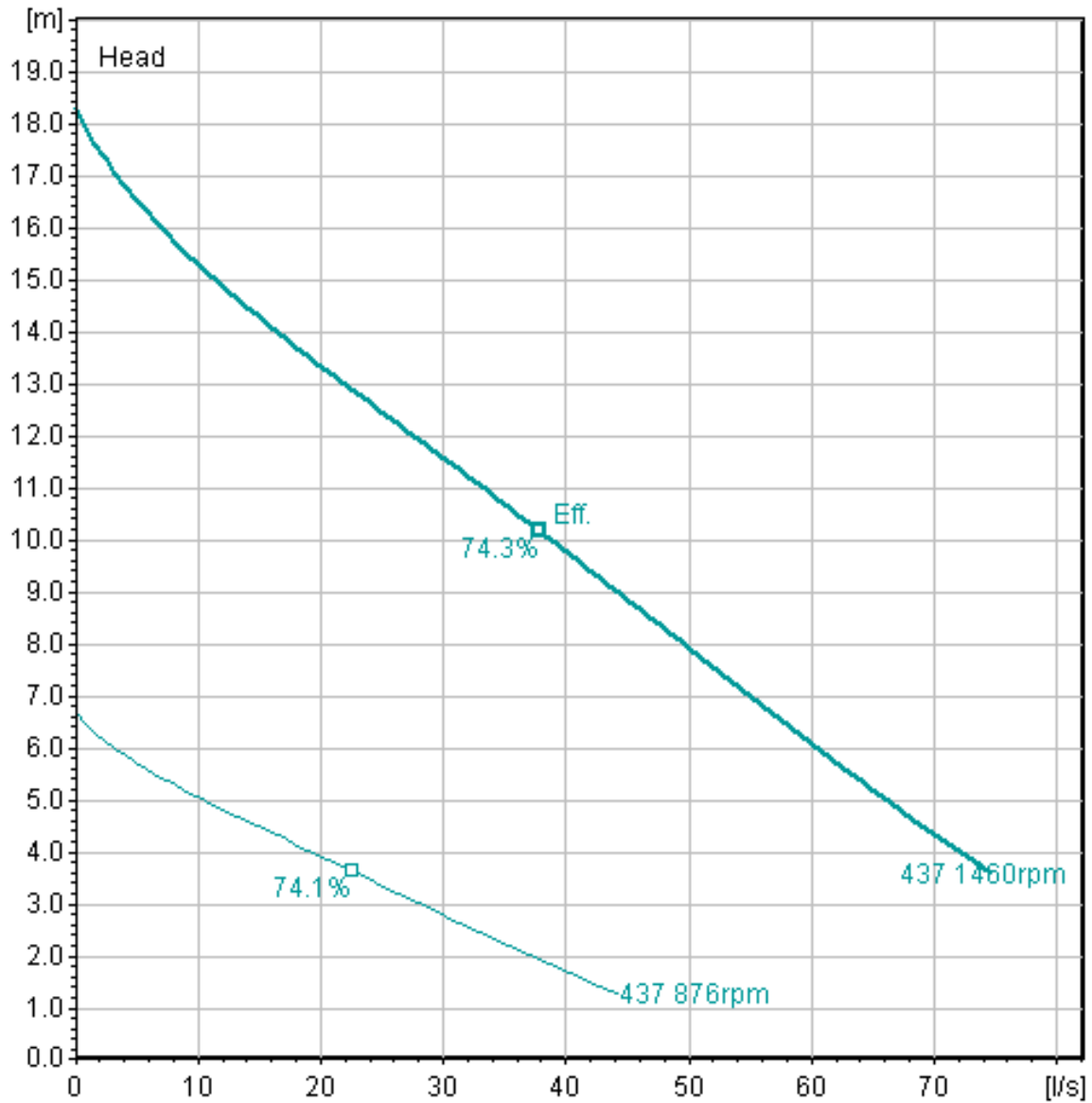

**Figure 42 Flygt n-3127 1460rpm**

Full details:

n-3127-mt-3-phase--4-poles-smartrun-50hz-metric-freq-50-measure-metric 1460rpm

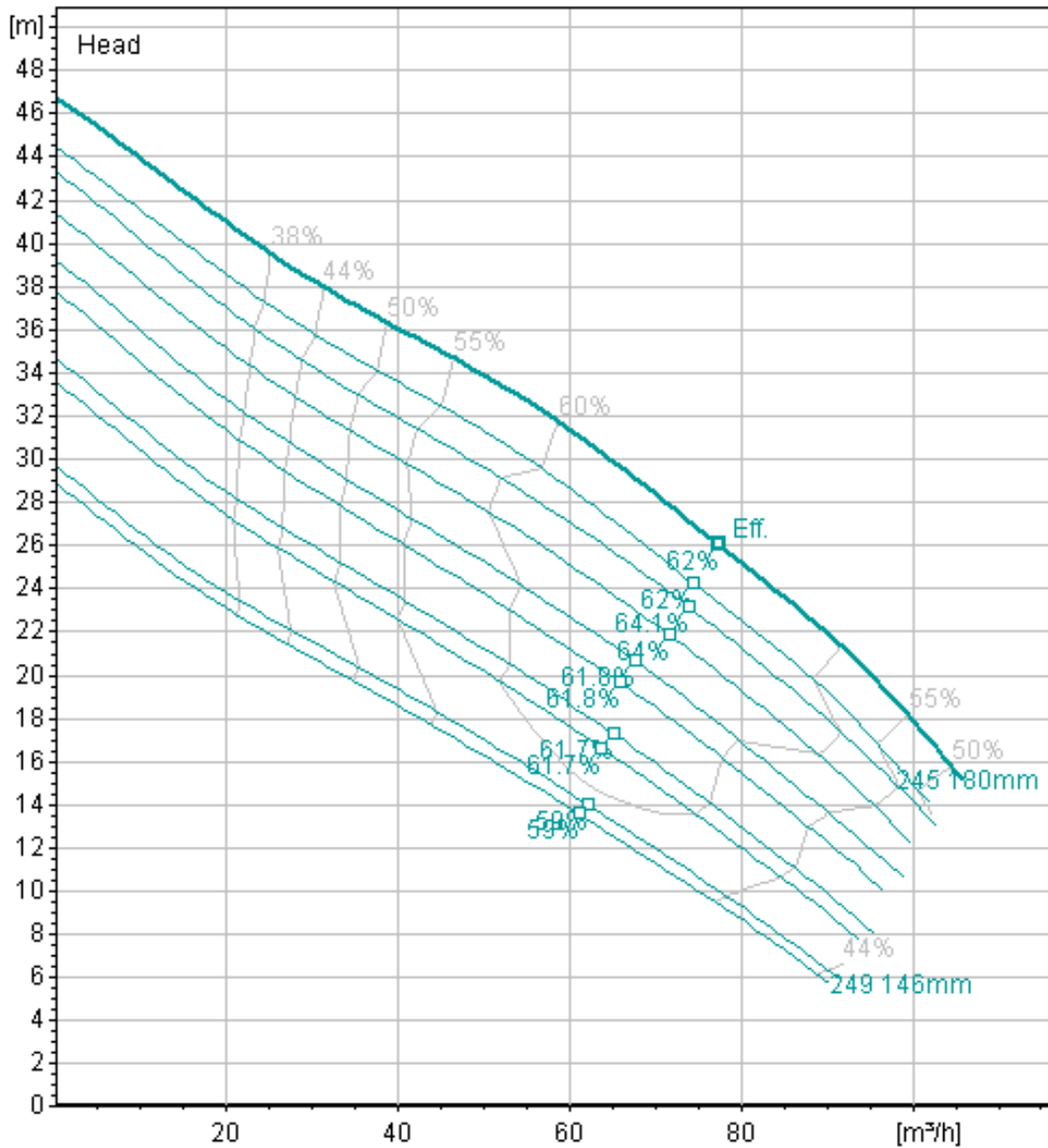

**Figure 43 Flygt n-3127 2900rpm efficiency curves**

Full details:

n-3127-sh-3-phase--adaptive-2-poles-smartrun-50hz-metric-freq-50-measure-metric 2900rpm efficiency curves

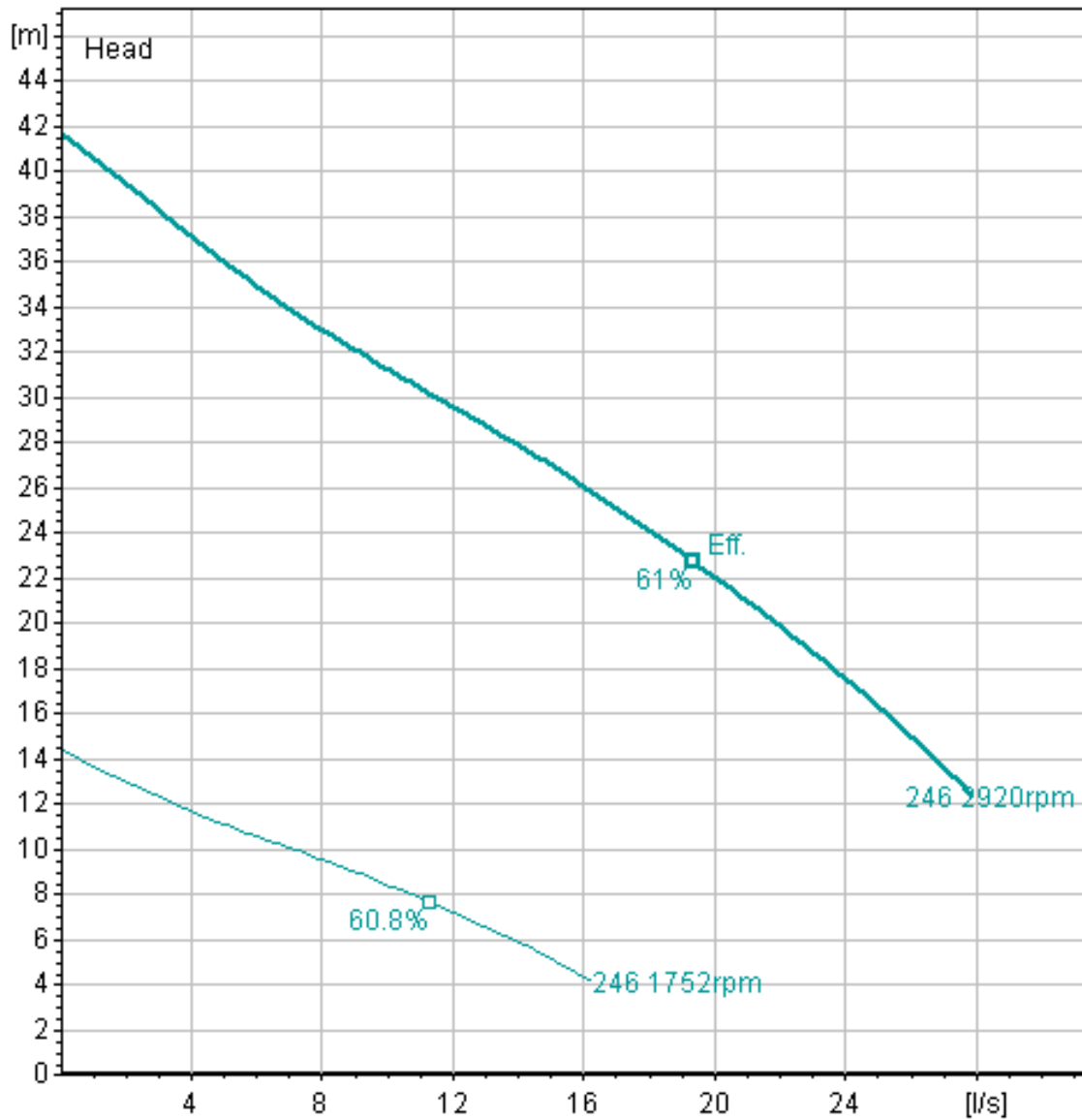

**Figure 44 Flygt n-3127 2900rpm**

Full details:

n-3127-sh-3-phase--adaptive-2-poles-smartrun-50hz-metric-freq-50-measure-metric 2900rpm

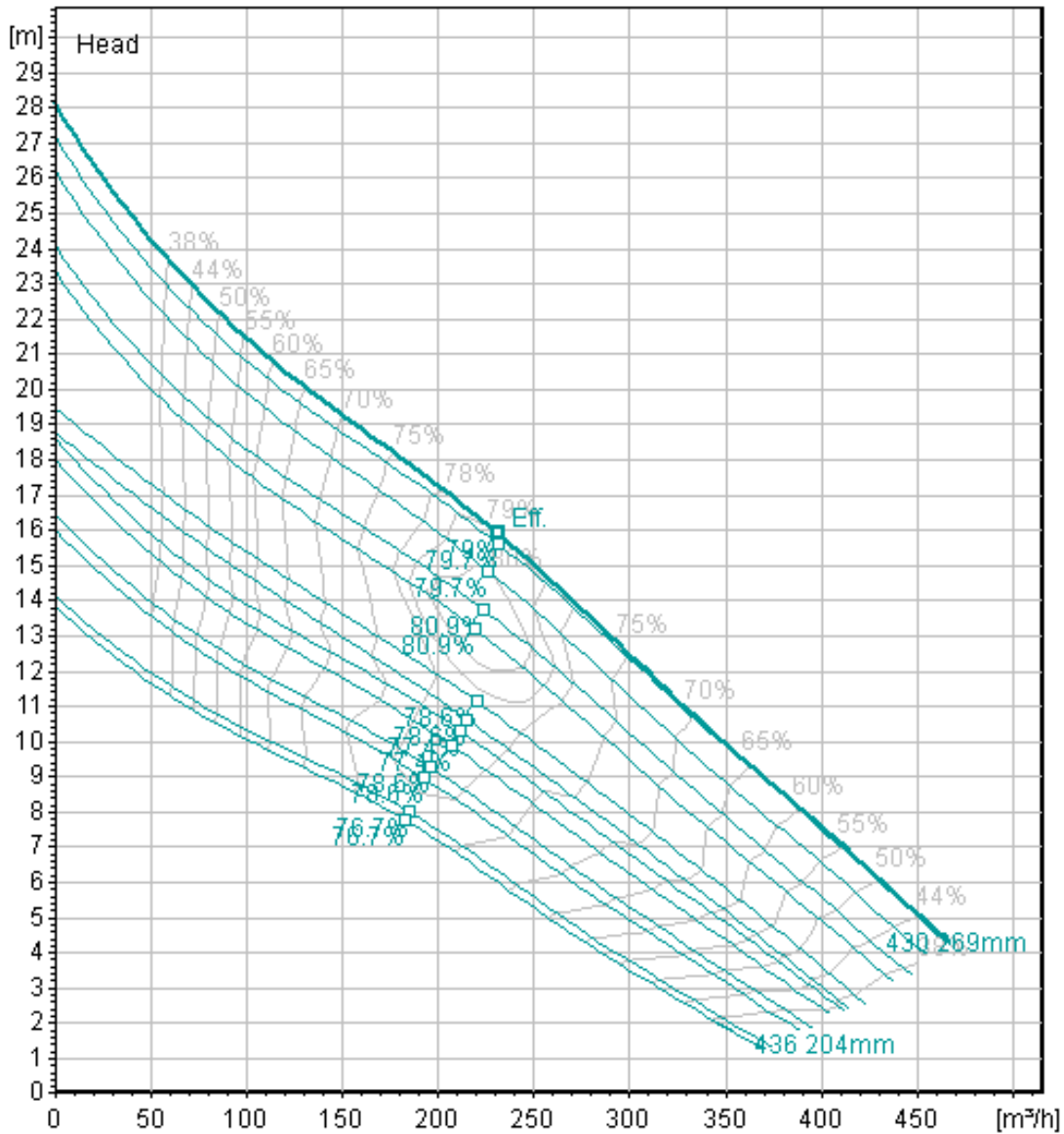

**Figure 45 Flygt n-3153 1500rpm efficiency curves**

Full details:

n-3153-mt-3-phase--4-poles-smartrun-50hz-metric-freq-50-measure-metric 1500rpm efficiency curves

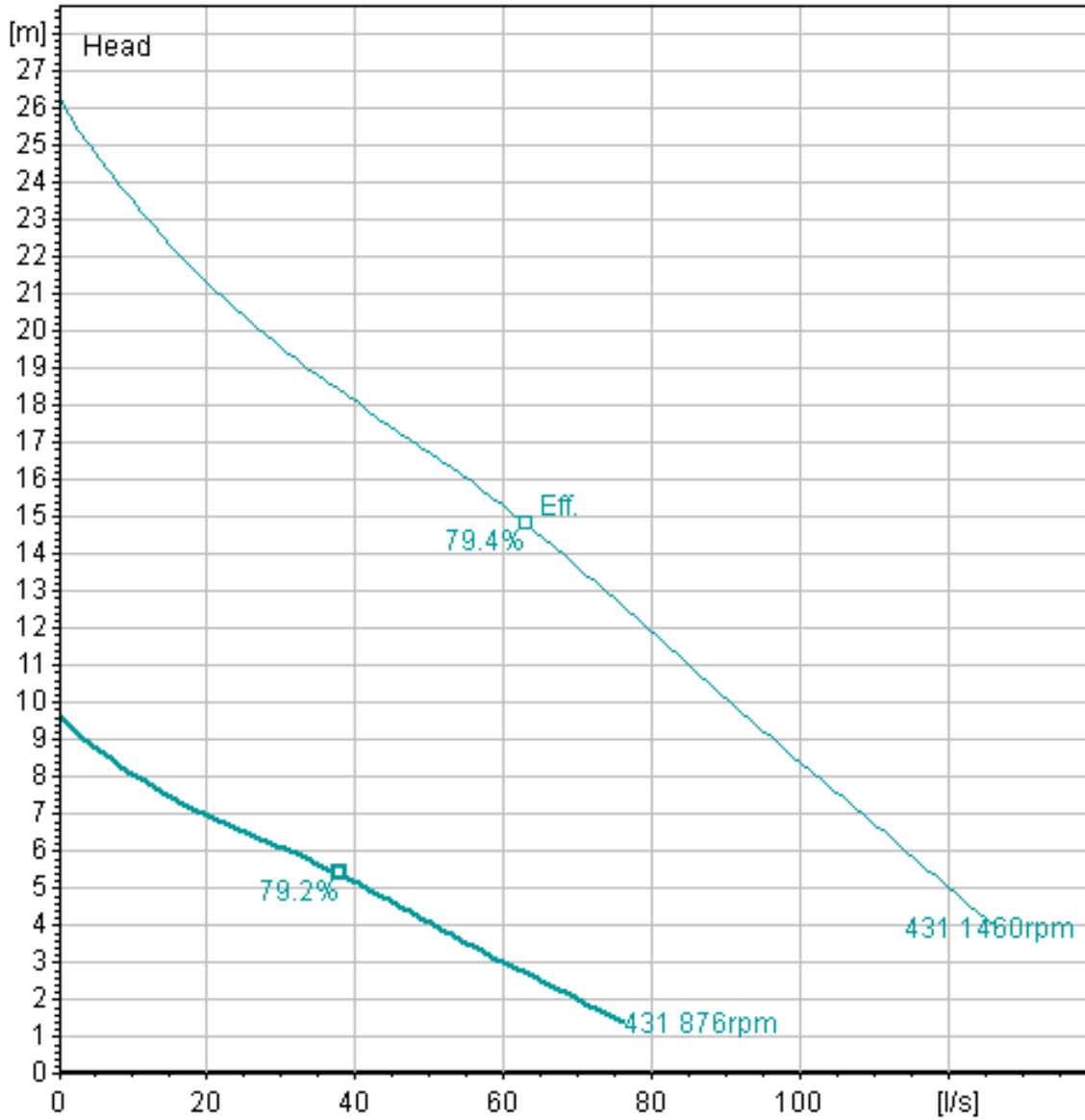

**Figure 46 Flygt n-3153 1500rpm**

Full details:

n-3153-mt-3-phase--4-poles-smartrun-50hz-metric-freq-50-measure-metric 1500rpm

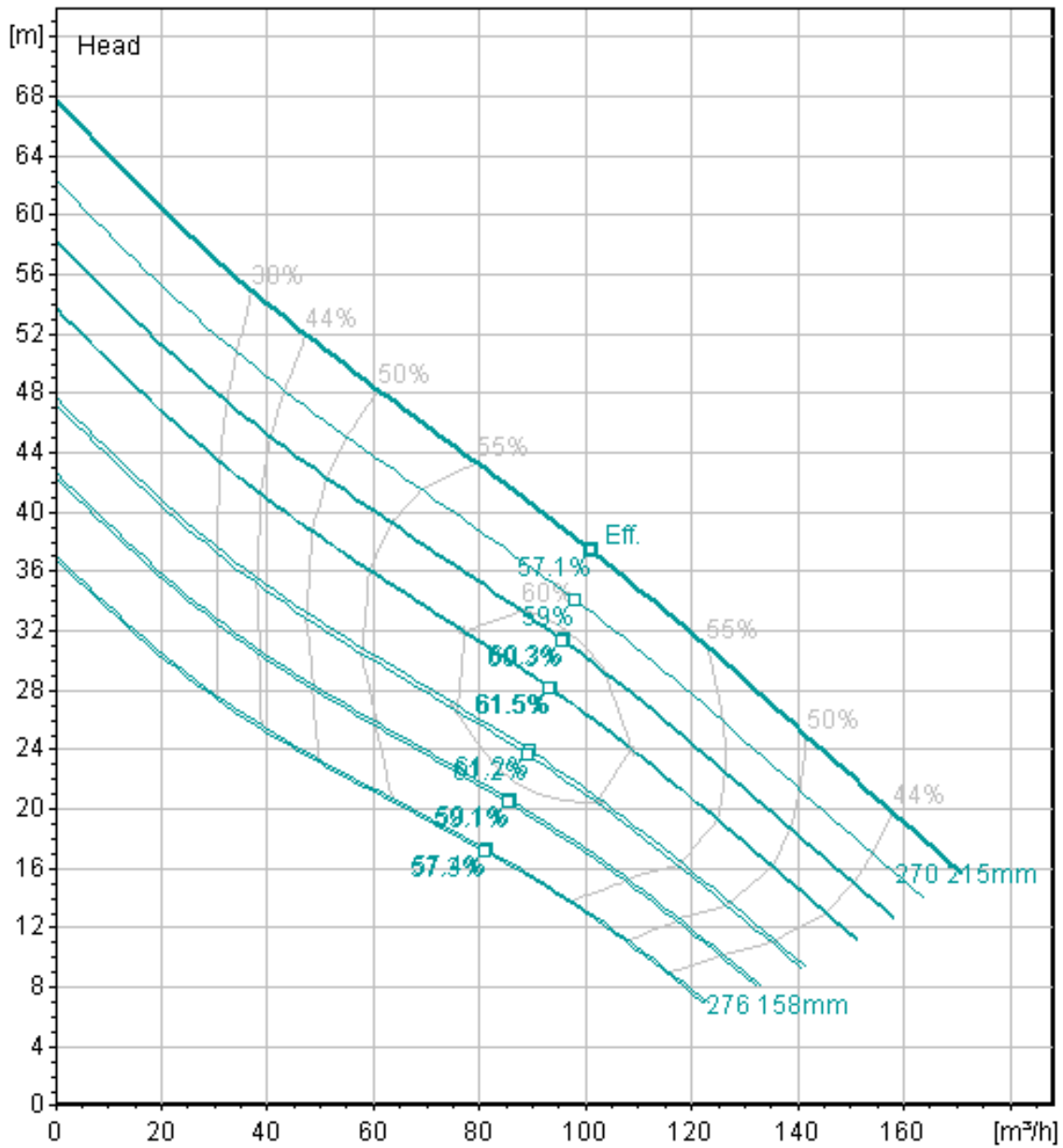
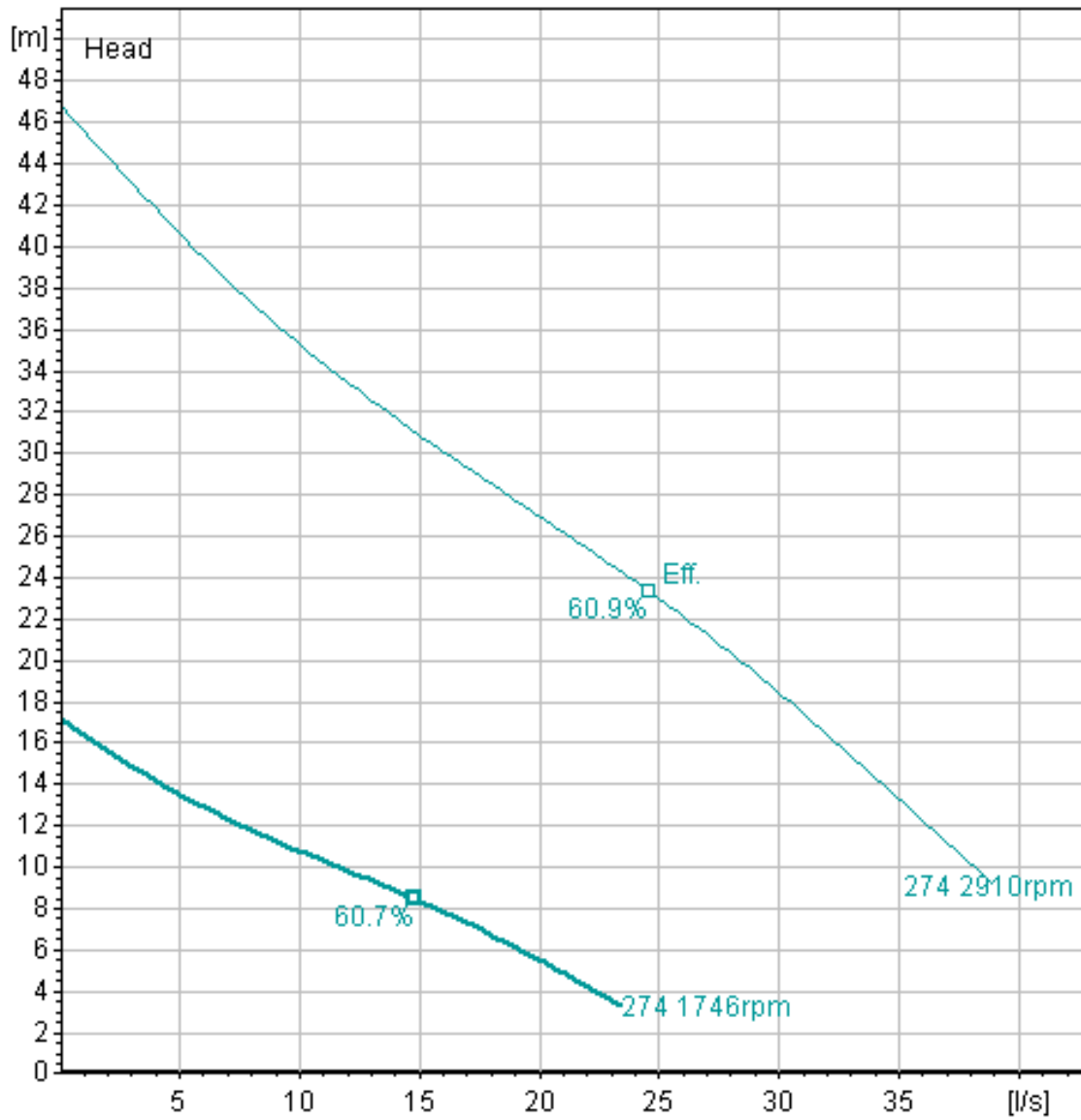

**Figure 47 Flygt n-3153-2900rpm efficiency curves**

Full details:

n-3153-sh-3-phase--2-poles-smartrun-50hz-metric-freq-50-measure-metric 2900rpm efficiency curves

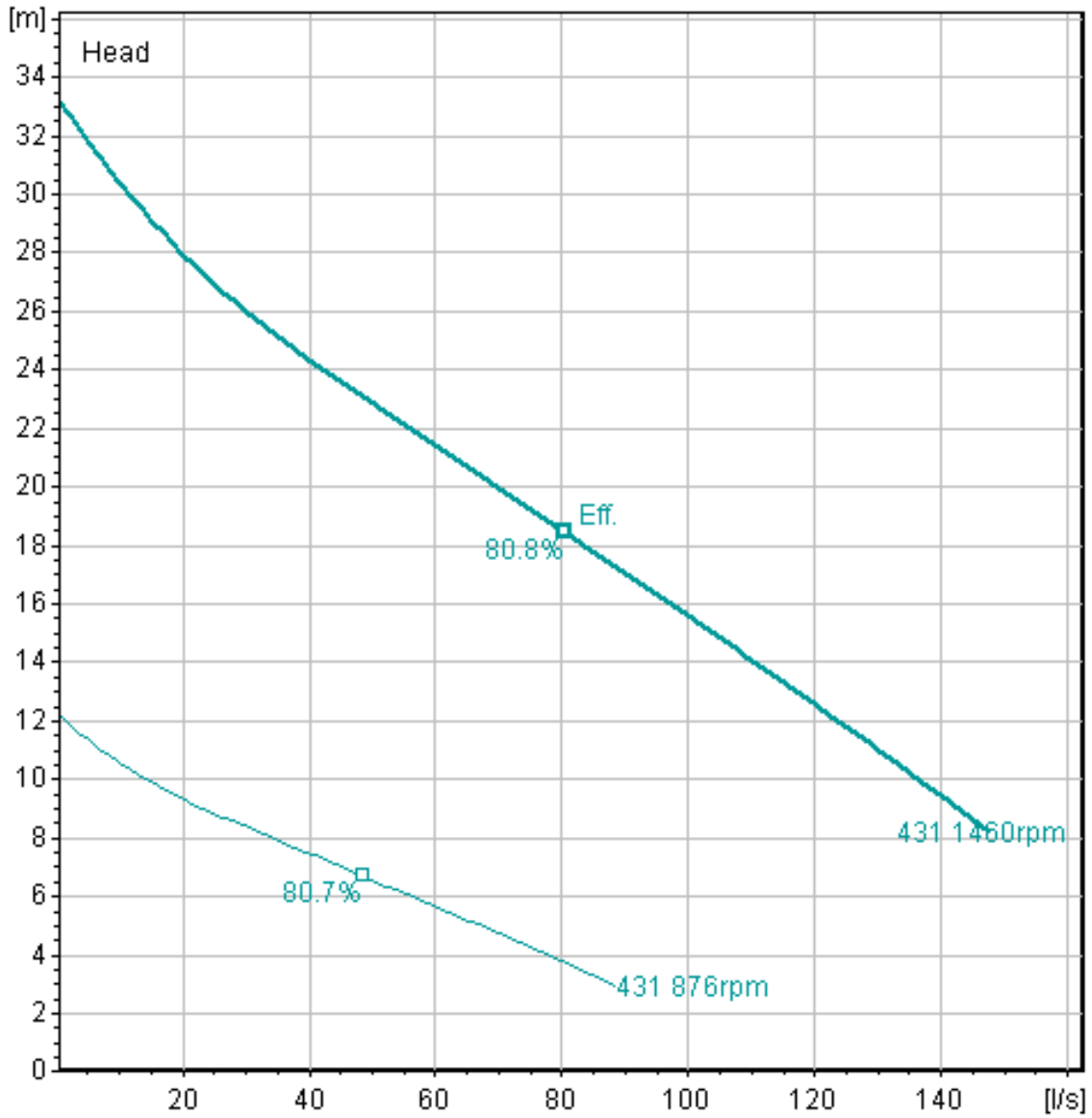



**Figure 48 Flygt n-3153 2900rpm**

Full details:

n-3153-sh-3-phase--2-poles-smartrun-50hz-metric-freq-50-measure-metric 2900rpm



**Figure 49 Flygt n-3171 1460rpm**

Full details:

n-3171-mt-3-phase--4-poles-smartrun-50hz-metric-freq-50-measure-metric 1460rpm

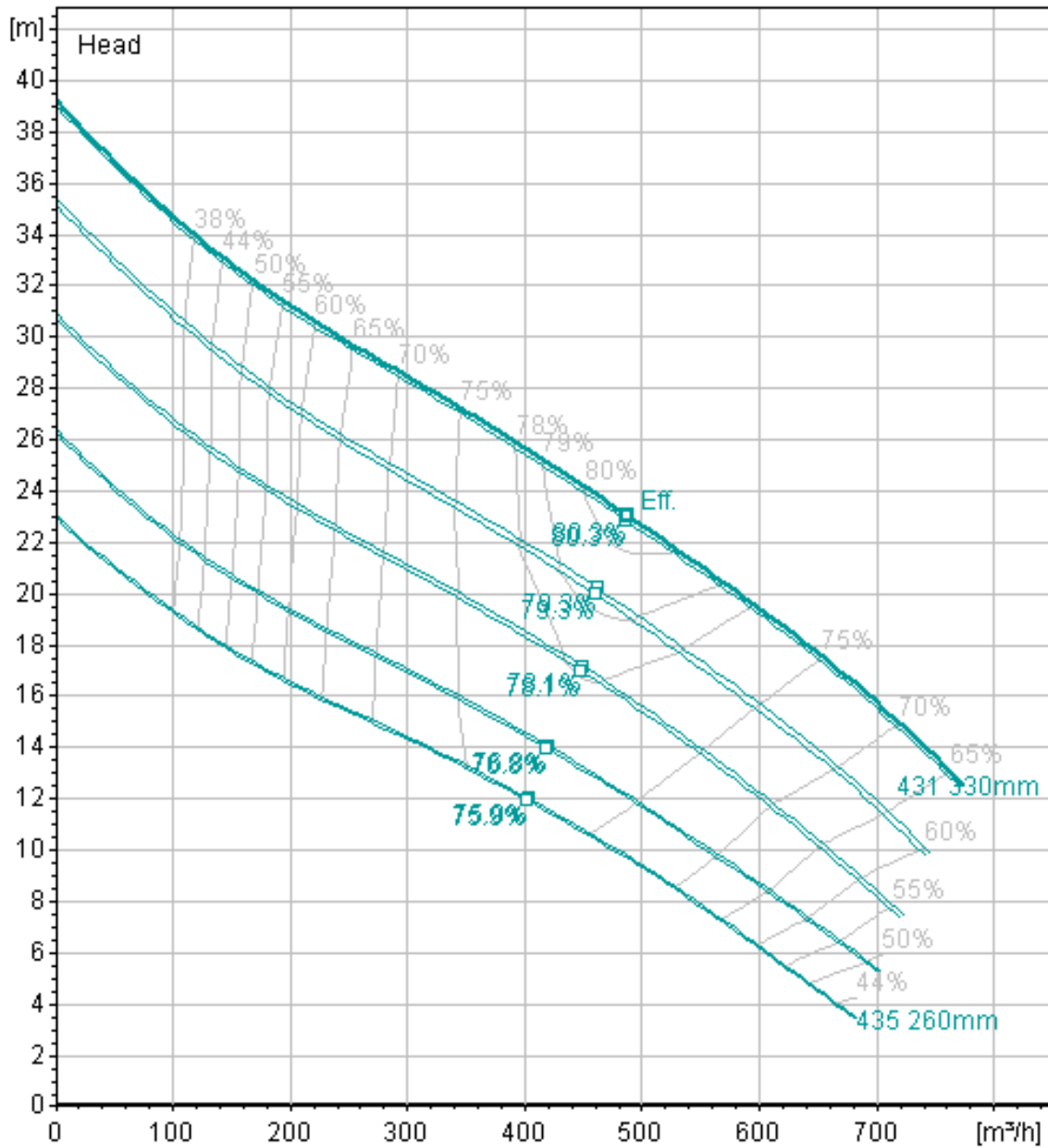

**Figure 50 Flygt n-3202 1475rpm efficiency curves**

Full details:

n-3202-mt-3-phase--4-poles-smartrun-50hz-metric-freq-50-measure-metric 1475rpm efficiency curves

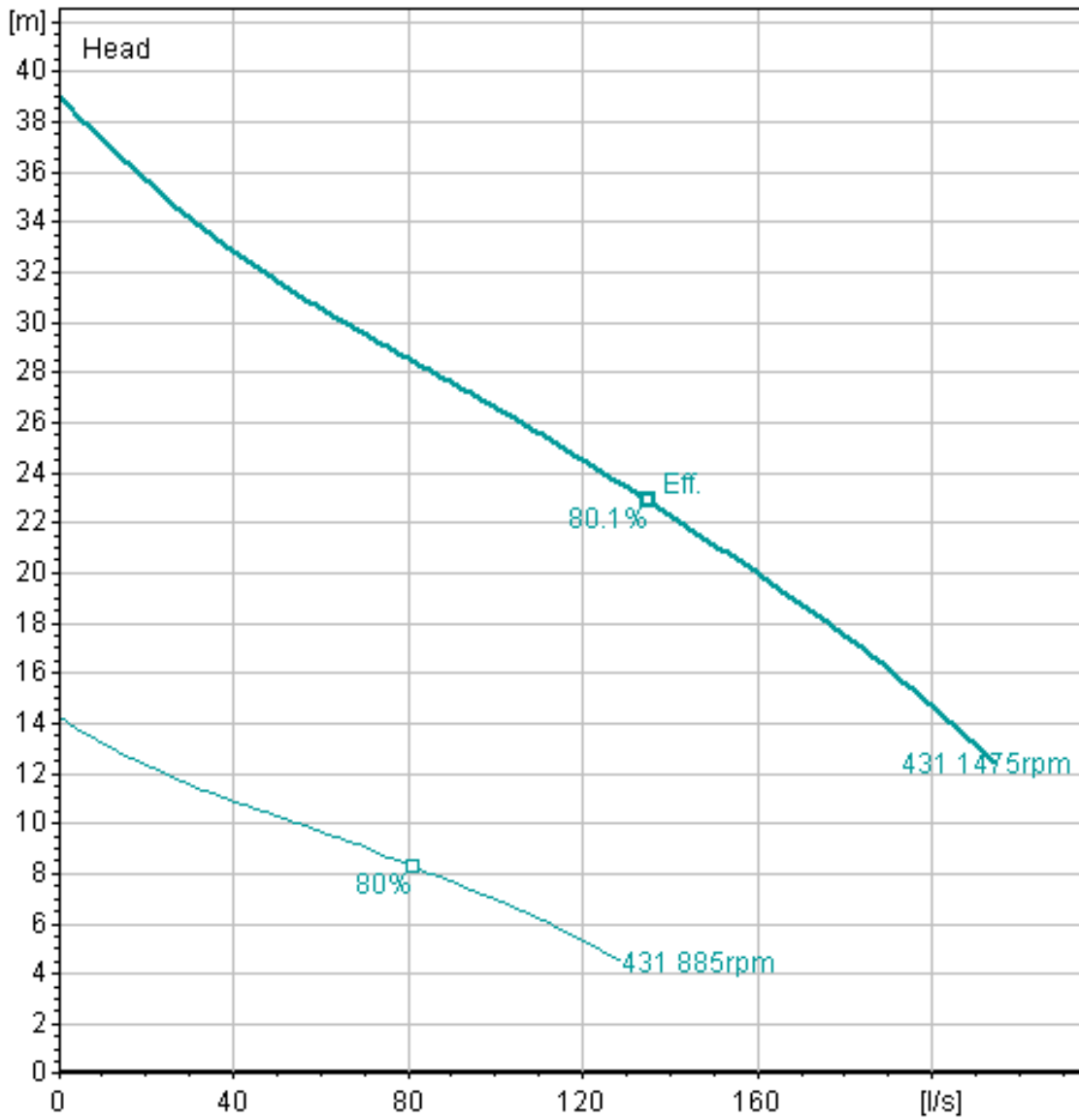

**Figure 51 Flygt n-3202 1475rpm**

Full details:

n-3202-mt-3-phase--4-poles-smartrun-50hz-metric-freq-50-measure-metric 1475rpm

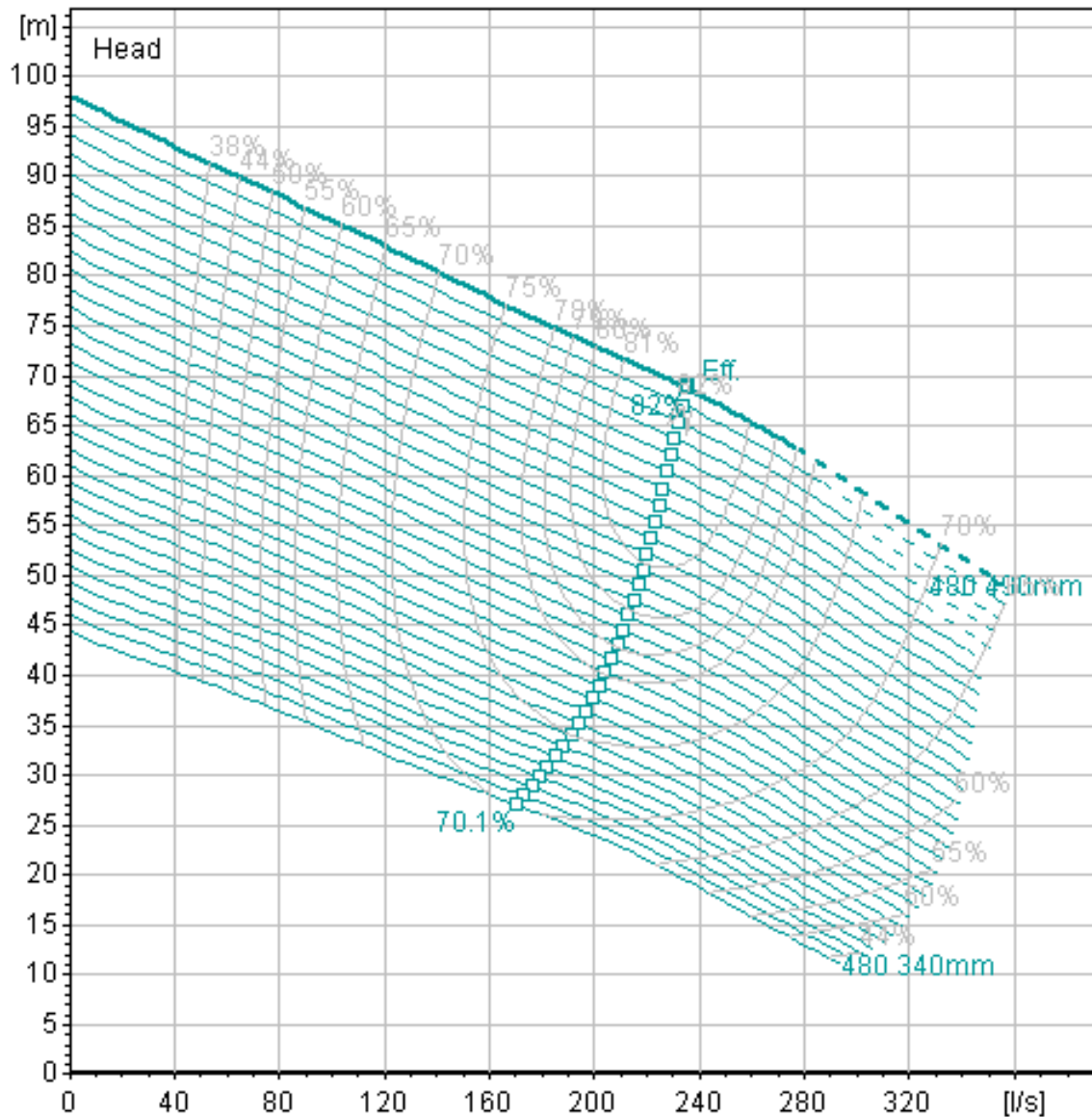

**Figure 52 Flygt n-3231**

Full details:  
 n-3231--3-phase--4-poles-480-50hz-metric-freq-50-measure-metric

XYLEM INC 2017. Technical Product Information (TPI). Online: Xylem Inc.,

**Optimisation of Water Companies Waste  
Pumping Asset Base with a Focus on Energy  
Reduction**

**Appendix 4 – CSV Data Dump for 31 Day Model  
Run**

**Alex Gray**

**2022**

*College of Engineering, Design and Physical  
Sciences Brunel University London*

Due to size of file, and the >500,000 rows of data, this excel is located on the Brunel Fig-Share repository.

[/https://brunel.figshare.com/](https://brunel.figshare.com/)



Alex Gray - Appendix 4 - CSV Data Dump for 31 day Model Run.zip

**Optimisation of Water Companies Waste  
Pumping Asset Base with a Focus on Energy  
Reduction**

**Appendix 5 – Configuration Dump of Mode-  
Frontier System**

**Alex Gray**

**2022**

*College of Engineering, Design and Physical  
Sciences Brunel University London*



# Contents

<b>List of Figures .....</b>	<b>277</b>
<b>1 Initial Optimiser Build – Design of Experiments (DoE) .....</b>	<b>278</b>
<i>1.1 The Power Calculation .....</i>	<i>295</i>
<b>2 Multi-Strategy Agent Optimiser Build – PiLOPT .....</b>	<b>298</b>
<b>3 Levenberg-Marquardt Optimiser Build .....</b>	<b>300</b>
<b>4 NSGA-II Optimiser Build .....</b>	<b>304</b>

## List of Figures

Figure 1 Scheduling Start [DOE Sequence] .....	278
Figure 2 Run Options.....	279
Figure 3 Duration Configuration.....	280
Figure 4 Timestep .....	281
Figure 5 Gauge Multiplier .....	282
Figure 6 Results Multiplier .....	283
Figure 7 ICM API Integration Setup .....	284
Figure 8 Whole Network Lost Flood Volume.....	285
Figure 9 Whole Network Stored Flood Volume.....	286
Figure 10 Sum of two Scalars .....	287
Figure 11 Condition the summated Flood Volume .....	288
Figure 12 The Constraint Function .....	289
Figure 13 Transfer File Function 1 .....	290
Figure 14 Transfer File Function 2 .....	291
Figure 15 Transfer File Function 3 .....	292
Figure 16 Pump Power Calculation Block.....	293
Figure 17 Easy Driver Configuration.....	294
Figure 18 Pump Power Output.....	296
Figure 19 Objective Function.....	297
Figure 20 PiLOPT Setup .....	298
Figure 21 PiLOPT Scheduler .....	299
Figure 22 PiLOPT Run Options.....	299
Figure 23 Levenberg-Marquardt Optimser Workflow .....	300
Figure 24 Levenberg-Marquardt Scheduler Properties.....	301
Figure 25 Levenberg-Marquardt DoE Setup.....	302
Figure 26 Levenberg-Marquardt Run Options .....	303
Figure 27 NSGA-II Workflow .....	304
Figure 28 NSGA-II Parameter Setup.....	305
Figure 29 NSGA-II Run Options.....	306
Figure 30 Levenberg-Marquardt and NSGA-II PumpPower Calc .....	307
Figure 31 Vector to Output Variable Java Script .....	308
Figure 32 Pump Power Minimum .....	309
Figure 33 Objective Function.....	310

# Initial Optimiser Build – Design of Experiments (DoE)

Starting Point: Original Mode-Frontier Workflow

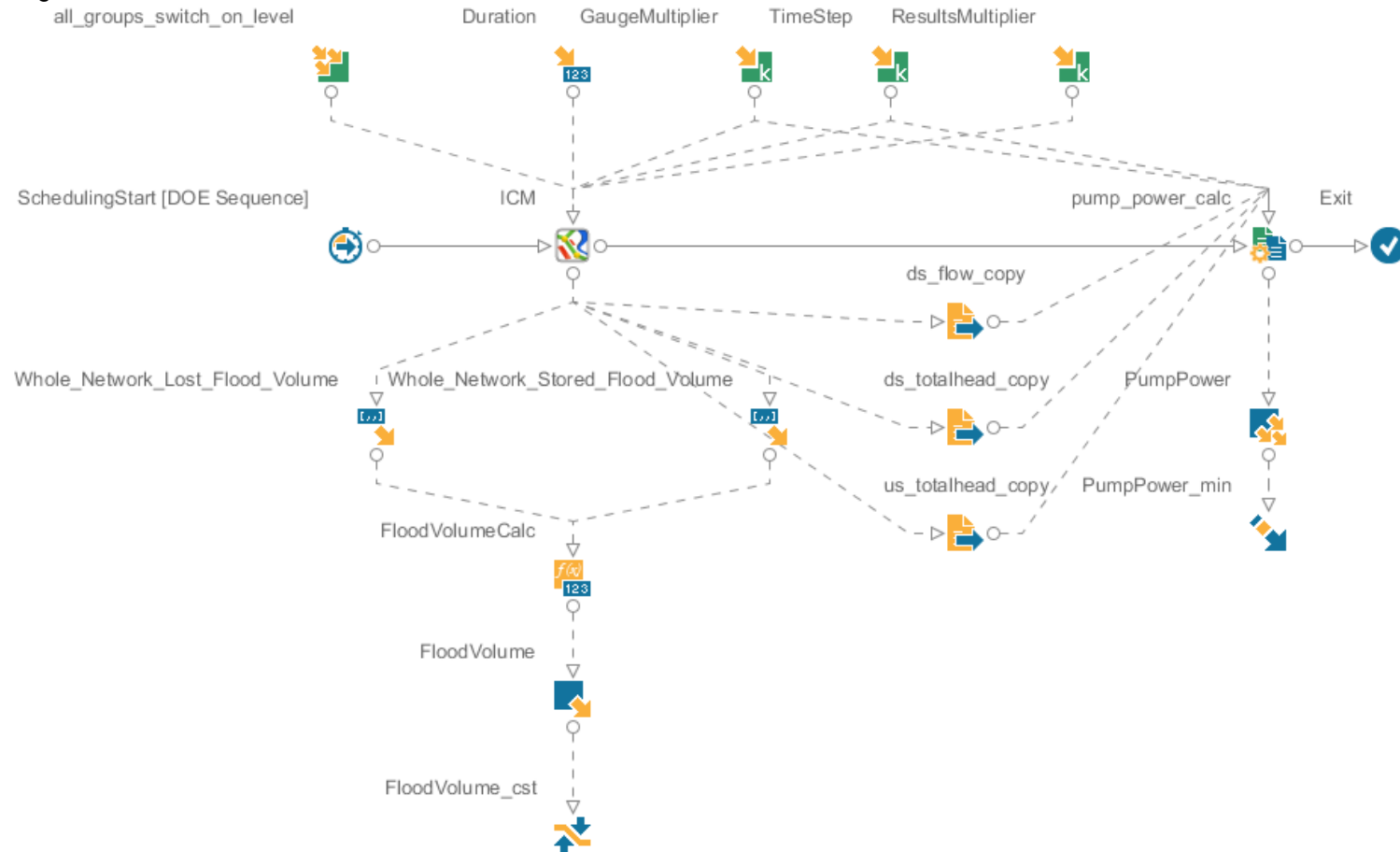

**Figure 53 Scheduling Start [DOE Sequence]**

Scheduling Start [DOE Sequence]

DOE Configuration: Set to yes, using newly created 84ULH table.

Session Configuration: This was set to add results to the original 'DesignTable'

Run Options:

Run Options

Num. of Concurrent Design Evaluations	<input type="text" value="1"/>
Save Error Design in DB	<input checked="" type="checkbox"/>
Evaluate Repeated Designs	<input type="checkbox"/>
Save Repeated Design in DB	<input type="checkbox"/>
Evaluate Unfeasible Designs	<input checked="" type="checkbox"/>
Force Error Design to NaN	<input checked="" type="checkbox"/>
Delete Design directory	<input type="text" value="Not On Failure"/>
Files to keep (comma separated filename patterns)	<input type="text"/>
Log Level	<input type="text" value="FINE - Most detailed"/>
Stop Optimization after (minutes)	<input type="text" value="0"/>

**Figure 54 Run Options**

All Groups Switch On Levels: Excel - DOE ULH84 All Groups Switch On Levels (This has all Pump Stations set to variable).

Duration Configuration:

The screenshot shows a software window titled "Input Parameter Node" with a blue header bar containing the "mF" logo and a close button. The window is divided into several sections:

- Properties:**
  - Parameter Name: Duration
  - Description: 44640 = 31 days in minutes (with a help icon)
  - Data Type: Scalar (dropdown menu)
  - Default Value: 44640.0
- Advanced Properties:**
  - Metainfo: (empty field with a help icon)
- Data Output Connector:**
  - ICM (with a small icon)

At the bottom of the window, there are three buttons: "OK", "Cancel", and "Help".

**Figure 55 Duration Configuration**

The duration was always fixed at 31days (1month), 44640minutes.

Timestep:

The screenshot shows a software dialog box titled "Input Variable Properties" with a blue header bar containing the "mf" logo and a close button. The dialog is organized into several sections:

- Input Variable Properties:** This section contains several fields:
  - Name:** A text box containing "TimeStep".
  - Description:** An empty text box with a small icon on the right.
  - Format:** A text box containing "0".
  - Type:** A dropdown menu currently set to "Constant".
  - Default Value:** A text box containing "5.0".
- MORDO Properties:** This section contains a dropdown menu for "Distribution" set to "None".
- Data Output Connector:** This section is expanded and shows two options: "ICM" and "pump\_power\_calc", each with a small icon.

At the bottom of the dialog, there are three buttons: "OK" (highlighted in grey), "Cancel", and "Help".

**Figure 56 Timestep**

The timestep, which is the sample rate of each model run, was set to a constant value of 5.

### Gauge Multiplier:

The screenshot shows a software dialog box titled "Input Variable Properties" with a blue header bar containing the "mf" logo and a close button. The dialog is organized into several sections:

- Input Variable Properties:**
  - Name:** GaugeMultiplier
  - Description:** (empty field with a help icon)
  - Format:** 0
  - Type:** Constant (dropdown menu)
  - Default Value:** 1.0
- MORDO Properties:**
  - Distribution:** None (dropdown menu)
- Data Output Connector:**
  - ICM
  - pump\_power\_calc

At the bottom of the dialog, there are three buttons: "OK" (highlighted in grey), "Cancel", and "Help".

**Figure 57 Gauge Multiplier**

The gauge multiplier was always fixed to a constant 1.0. This is the sample rate, from the timestep of the results that are required for inspection. So with the above timestep of 5seconds, multiplied by 1 meant that all required results were 5second snapshots.

Results multiplier:

The screenshot shows a software dialog box titled "Input Variable Properties" with a blue header bar containing the "mF" logo and a close button. The dialog is organized into sections. The "Input Variable Properties" section includes fields for Name (ResultsMultiplier), Description (with a help icon), Format (0), Type (Constant), and Default Value (900.0). The "MORDO Properties" section includes a Distribution dropdown set to None. The "Data Output Connector" section shows the ICM icon. At the bottom, there are three buttons: OK, Cancel, and Help.

Property	Value
Name	ResultsMultiplier
Description	
Format	0
Type	Constant
Default Value	900.0
MORDO Properties - Distribution	None
Data Output Connector	ICM

**Figure 58 Results Multiplier**

The results multiplier, which is the sample rate for all recorded model results outside of the gauge, (i.e., those results that the experiment is not interested in) is set to 900 seconds, 15minutes.



## ICM Node Setup

**mf ICM v4.25.4 (InfoWorks/ICM) Properties**

**ICM v4.25.4 Properties**  
 Description: ICM v4.25.4

**ICM v4.25.4 Additional Properties**  
 ICM Version [7.0, 7.5, 8.0, 8.5, 9.0, 9.5]: 8.5  
 ICM Exchange Executable (\*.exe): C:\Program Files (x86)\Innovyze Workgroup Client 8.5\Exchange.exe  
 ICM Database (\*.icmm) or Server (\\hostname:port\database): D:\modeFRONTIER\Database\Bordon R720.icmm  
 ICM Database Server (\\hostname:port\database):  
 Run Path (example: >ModelGroup>ModelGroup>Run): >BordonUpdated>mF>MFBASE\_A\_HDC  
 Simulation Server - options [/LOCAL/ANY]:  
 Number of Simulation Threads - options [0/1/2/3 etc...]:  
 Store Results on Server:   
 Select Cost Model File (Can be created using Edit Model button):  
 Select Verification Target File (Can be created using Edit Model button):  
 Observed Flow Event Path (example:>ModelGroup>FlowSurvey>Flow):  
 Observed Depth Event Path (example:>ModelGroup>FlowSurvey>Depth):  
 Disable Validation (use at own risk):   
 Data Clean-up Policy - options [SIMS/RUNS/ALL]: ALL  
 Enable Inputs to be exported as outputs:   
 Introspect extended input parameters:   
 Introspect network objects individually:   
 Override the above parameters from file (\*.txt):

**ICM v4.25.4 Advanced Properties**  
 Timeout: 0

**Process Input Connector**  
 SchedulingStart

**Data Input Connector**

**Process Output Connector**  
 pump\_power\_calc: EXIT

**Data Output Connector**  
 ds\_flow\_copy: Duty\_Assist\_Standby DWF\_link\_ds\_flow\_gau...  
 ds\_totalhead\_copy: Duty\_Assist\_Standby DWF\_link\_ds\_totalhea...  
 us\_totalhead\_copy: Duty\_Assist\_Standby DWF\_link\_us\_totalhea...

**Figure 117 ICM API Integration Setup**

This is the configuration of how Mode-Frontier will integrate with the Infoworks ICM environment.

### Whole Network Lost Flood Volume:

The screenshot shows a software window titled "mF Output Parameter Node". The window is divided into several sections:

- Properties:**
  - Parameter Name: Whole\_Network\_Lost\_Flood\_Volume
  - Description: (empty text box with a help icon)
  - Data Type: Vector (dropdown menu)
  - Vector Size: 2186
- Advanced Properties:**
  - Metainfo: (empty text box with a help icon)
- Data Output Connector:**
  - FloodVolumeCalc (indicated by a small icon)

At the bottom of the window, there are three buttons: "OK", "Cancel", and "Help".

**Figure 60 Whole Network Lost Flood Volume**

This is an inspected output variable from the Infoworks ICM model run. It picks up any totalised lost flood volume during the model run.

Whole Network Stored Flood Volume:

The screenshot shows a software window titled "mF Output Parameter Node". The window is divided into several sections:

- Properties:**
  - Parameter Name: Whole\_Network\_Stored\_Flood\_Volume
  - Description: (empty text box with a help icon)
  - Data Type: Vector (dropdown menu)
  - Vector Size: 2186
- Advanced Properties:**
  - Metainfo: (empty text box with a help icon)
- Data Output Connector:**
  - FloodVolumeCalc (indicated by a small icon)

At the bottom of the window, there are three buttons: "OK", "Cancel", and "Help".

**Figure 61 Whole Network Stored Flood Volume**

This is an inspected output variable from the Infoworks ICM model run. It picks up any totalised stored flood volume during the model run.

### Calculation: Sum of two Scalars

The screenshot shows the 'Expression Buffer Properties' dialog box in the mF software. The dialog is titled 'mF Expression Buffer Properties' and has a close button (X) in the top right corner. It is divided into several sections:

- Properties:**
  - Parameter Name: FloodVolumeCalc
  - Description: (empty field)
  - Data Type: Scalar
  - Expression:  $\text{sum}(\text{Whole\_Network\_Lost\_Flood\_Volume}) + \text{sum}(\text{Whole\_Network\_Stored\_Flood\_Volume})$
- Advanced Properties:**
  - Metainfo: (empty field)
- Data Input Connector:**
  - Whole\_Network\_Lost\_Flood\_Volume
  - Whole\_Network\_Stored\_Flood\_Volume
- Data Output Connector:**
  - FloodVolume

At the bottom of the dialog, there are three buttons: 'OK', 'Cancel', and 'Help'.

**Figure 62 Sum of two Scalars**

This takes the Whole Network Lost and Whole Network Stored flood volumes and adds them together for an overall totalised network flood volume.

Condition the summated Flood Volume:

The screenshot shows the 'Output Variable Properties' dialog box. The 'Name' field is set to 'FloodVolume' and the 'Format' field is set to '0.000'. The 'Data Output Connector' is set to 'FloodVolume\_cst'. The 'OK' button is highlighted.

**Figure 63 Condition the summated Flood Volume**

This block assembles the output value from the Flood Volume calculation into a format for the constraint function to operate from. (Format 0.000)

The Constraint Function:

The screenshot shows a dialog box titled "mF Constraint Properties". It is divided into two main sections: "Constraint Properties" and "Constraint Expression Properties".

- Constraint Properties:**
  - Name: FloodVolume\_cst
  - Description: (empty)
  - Enabled:
  - Format: 0.000
- Constraint Expression Properties:**
  - User Expression: FloodVolume
  - Type: Equal To
  - Limit: 0.0
  - Tolerance: 0.0

Below these sections is a "Data Input Connector" section with a single entry: "FloodVolume".

At the bottom of the dialog are three buttons: "OK", "Cancel", and "Help".

**Figure 64 The Constraint Function**

Within the workflow there is a single constraint which is simply, 'There must be no flood volume at any point within the model'. Hence, the properties are set to Flood volume Equal to 0.0 with a 0.0 tolerance.

### Transfer File Function 1:

**Transfer File Properties**

Transfer File Node Name: ds\_flow\_copy

Description: [Empty]

Base Dir: .

Verbose:

Transfer Files | Connectors

+ Add File | X Remove File

	Move	File Name
1	<input checked="" type="checkbox"/>	Duty_Assist_Standby DWF_link_ds_flow_gaugeresults.csv

OK Cancel Help

**Figure 65 Transfer File Function 1**

This block takes a CSV dump of the Infoworks ICM output results for downstream flow 'ds\_flow\_copy' (a Gauged parameter).

## Transfer File Function 2:

Transfer File Properties

Transfer File Node Name: ds\_totalhead\_copy

Description: [Empty]

Base Dir: .

Verbose:

Transfer Files | Connectors

+ Add File | X Remove File

	Move	File Name
1	<input checked="" type="checkbox"/>	Duty_Assist_Standby DWF_link_ds_totalhead_gaugeresults.csv

OK Cancel Help

**Figure 66 Transfer File Function 2**

This block takes a CSV dump of the Infoworks ICM output results for downstream total head 'ds\_totalhead\_copy' (a Gauged parameter).



### Transfer File Function 3:

**Transfer File Properties**

Transfer File Node Name: us\_totalhead\_copy

Description: [Empty]

Base Dir: .

Verbose:

Transfer Files | Connectors

+ Add File    × Remove File

	Move	File Name
1	<input checked="" type="checkbox"/>	Duty_Assist_Standby DWF_link_us_totalhead_gaugeresults.csv

OK    Cancel    Help

**Figure 67 Transfer File Function 3**

This block takes a CSV dump of the Infoworks ICM output results for upstream total head 'us\_totalhead\_copy' (a Gauged parameter).

## Pump Power Calculation Block:

mf EasyDriver Properties

Edit EasyDriver Edit EasyDriver Preferences Test SSH Connection Export to Plugin

EasyDriver Properties

EasyDriver Node Name pump\_power\_calc

Description

EasyDriver Advanced Properties

Timeout [s] 0

Use Grid System

SSH execution

Set job dir to variable APPL\_PWD

Set design ID to variable DESIGN\_ID

Set user name to variable ESTECO\_USER

Set project name to variable PROJECT\_NAME

SSH Script Server Properties

SSH Script X11 Properties

Process Input Connector

ICM EXIT

Data Input Connector

GaugeMultiplier Rules defined

TimeStep Rules defined

ds\_flow\_copy Duty\_Assist\_Standby DWF\_link\_ds\_flow\_gau...

ds\_totalhead\_copy Duty\_Assist\_Standby DWF\_link\_ds\_totalhea...

us\_totalhead\_copy Duty\_Assist\_Standby DWF\_link\_us\_totalhea...

us\_totalhead\_copy  
us\_totalhead\_copy

Process Output Connector

PumpPowerCalc EXIT

Data Output Connector

PumpPower Mining rule defined

OK Cancel Help

**Figure 126 Pump Power Calculation Block**

This block takes the three transfer file outputs for DS Flow, DS Head and US Head, along with the gauge multiplier and timestep constants and uses an easy driver script based calculation to process the results.

## Easy Driver Configuration:

The screenshot shows the 'Edit EasyDriver Files' window with a VBS script editor and a 'Rule Properties' table. The script contains logic for file existence checks and CSV reading. The 'Rule Properties' table lists two rules: 'Gaug...' and 'Time...'. The 'Gaug...' rule is active, with a start line of 14 and end line of 20. The 'Time...' rule is also listed with a start line of 15 and end line of 13.

```

1 If Not fileExists("Duty_Assist_Standby DWF_link_ds_flow_gaugeresults.csv") then
2 WScript.Quit
3 ElseIf Not fileExists("Duty_Assist_Standby DWF_link_ds_totalhead_gaugeresults.csv") then
4 WScript.Quit
5 ElseIf Not fileExists("Duty_Assist_Standby DWF_link_us_totalhead_gaugeresults.csv") then
6 WScript.Quit
7 End If
8 ds_flow = readCSV("Duty_Assist_Standby DWF_link_ds_flow_gaugeresults.csv")
9 ds_totalhead = readCSV("Duty_Assist_Standby DWF_link_ds_totalhead_gaugeresults.csv")
10 us_totalhead = readCSV("Duty_Assist_Standby DWF_link_us_totalhead_gaugeresults.csv")
11
12 Wscript.Echo "Calculating PumpPower..."
13
14 GaugeMultiplier = 1
15 TimeStep = 5
16
17 dim myMechEnergy ()
18 dim myInstantaneousPower ()
19 dim myPumpPower ()
20 rows = Ubound(ds_flow,1)
21 columns = Ubound(ds_flow,2)
22 redim myMechEnergy (columns)
23 redim myInstantaneousPower (columns)
24 redim myPumpPower (columns)
25

```

	Variable	Anchor St...	Rule Status	Anchor	Start Line	Start Colu...	End Line	End Column	Format St...	Decimal S...	Format
0	Gaug...	✓	✓	start of file	14	19	14	20	Java For...	Dot	#0
1	Time...	✓	✓	start of file	15	12	15	13	Java For...	Dot	#0

Figure 69 Easy Driver Configuration

## 11.1 The Power Calculation

The script contained within this file has a lot of conditioning logic to ensure that the format of the data is aligned, which was not available for extraction from the software. The below provides power the calculation logic.

```
dim myMechEnergy()
dim myInstantaneousPower()
dim myPumpPower()
rows = Ubound(ds_flow,1)
columns = Ubound(ds_flow,2)
redim myMechEnergy(columns)
redim myInstantaneousPower(columns)
redim myPumpPower(columns)

myTimeStepConditioning = 3600/(GaugeMultiplier*TimeStep)
myMotorEfficiency = 0.8
myPumpEfficiency = 0.75
myCorrectionFactor = 3.5

dim myTempArray
redim myTempArray(rows)
WScript.Echo
"row,column,ds_flow,ds_totalhead,us_totalhead,myCombinedHead,myMechEnergy,myInstantaneous
Power"
For i = 0 to rows
    For k = 0 to columns
        if i = 0 then myMechEnergy(k) = myTempArray
        if i = 0 then myInstantaneousPower(k) = myTempArray
        myCombinedHead = ds_totalhead(i,k)+us_totalhead(i,k)
        myMechEnergy(k)(i) = ((ds_flow(i,k)*1000)* 1000 * 9.81 * myCombinedHead)/3600000
        myInstantaneousPower(k)(i) = (myMechEnergy(k)(i) / myMotorEfficiency / myPumpEfficiency) *
myCorrectionFactor
        If i < 50 Then
            WScript.Echo CStr(i) + "," + CStr(k) + "," + CStr(ds_flow(i,k)) + "," + CStr(ds_totalhead(i,k)) + "," +
CStr(us_totalhead(i,k)) + "," + CStr(myCombinedHead) + "," + CStr(myMechEnergy(k)(i)) + "," +
CStr(myInstantaneousPower(k)(i))
        End If
    Next
Next
```

## Pump Power Output

mf Vector Output Variable Properties

Vector Output Variable Properties

Name: PumpPower

Description: [Empty]

Size: 42

Outputs Variables | Connectors

+ × ↑ ↑ ↓ ↓ ↓ ↑

	Description	Format
0		#0.000
1		#0.000
2		#0.000
3		#0.000
4		#0.000
5		#0.000

OK Cancel Help

**Figure 70 Pump Power Output**

This is the 42length vector output from the pump power calculation script.

Objective Function:

The screenshot shows a dialog box titled "Objective Properties" with the following fields and values:

- Objective Properties:**
  - Name: PumpPower\_min
  - Description: (empty)
  - Enabled:
  - Format: 0.000
- Objective Expression Properties:**
  - User Expression: sum(PumpPower)
  - Type: Minimize
- Data Input Connector:**
  - PumpPower

Buttons at the bottom: OK, Cancel, Help.

**Figure 71 Objective Function**

This block takes the PumpPower vector and uses a summation expression to generate the overall catchment power, which then is used in the minimise objective function.

## Multi-Strategy Agent Optimiser Build – PiLOPT

PiLOPT: This was the first optimiser session which used the PiLOPT function, a multi-strategy optimiser that starts with a global search function and then switches to a local search. The PiLOPT workflow was exactly the same as the DOE ULH84, the only change was the scheduler.

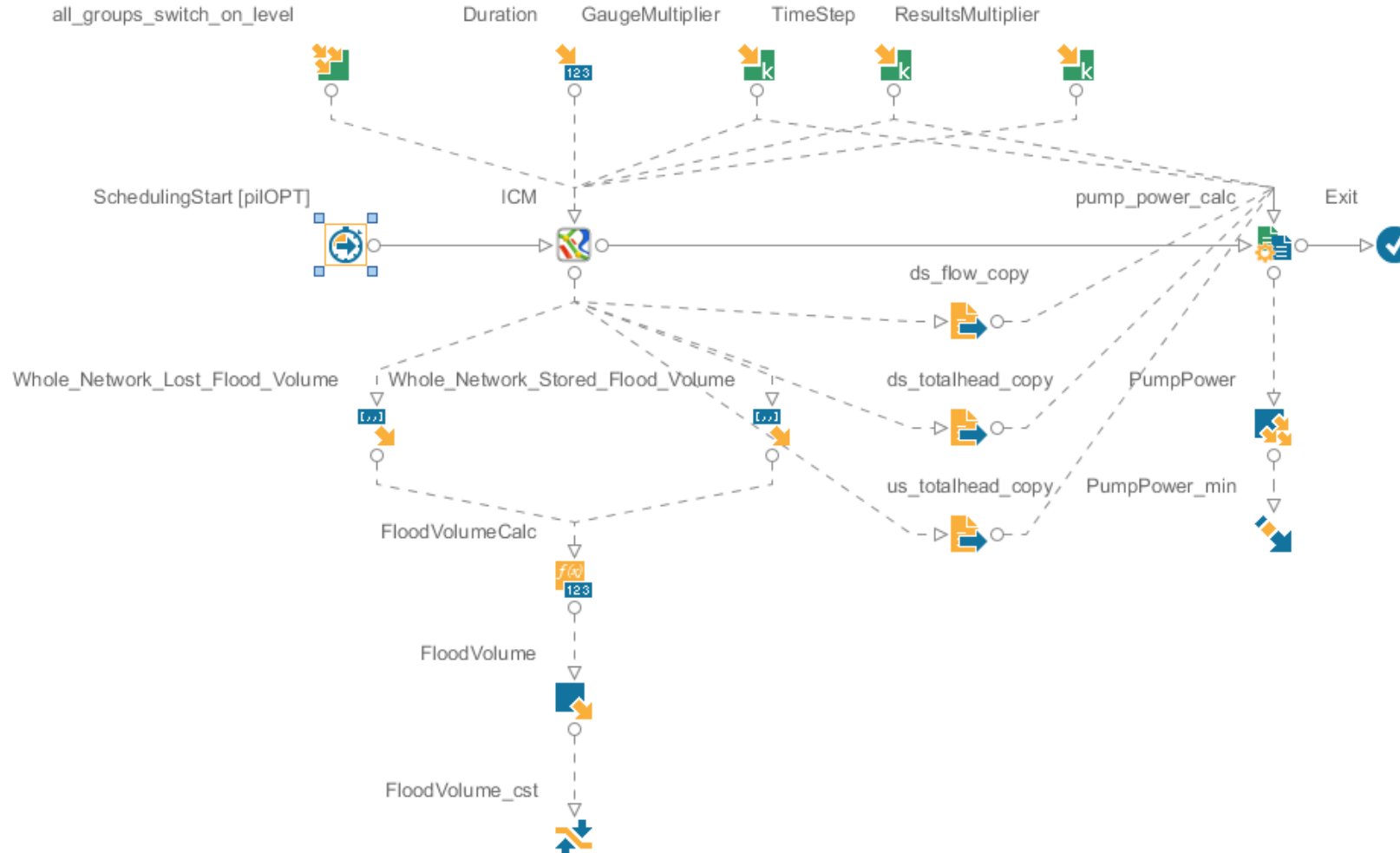
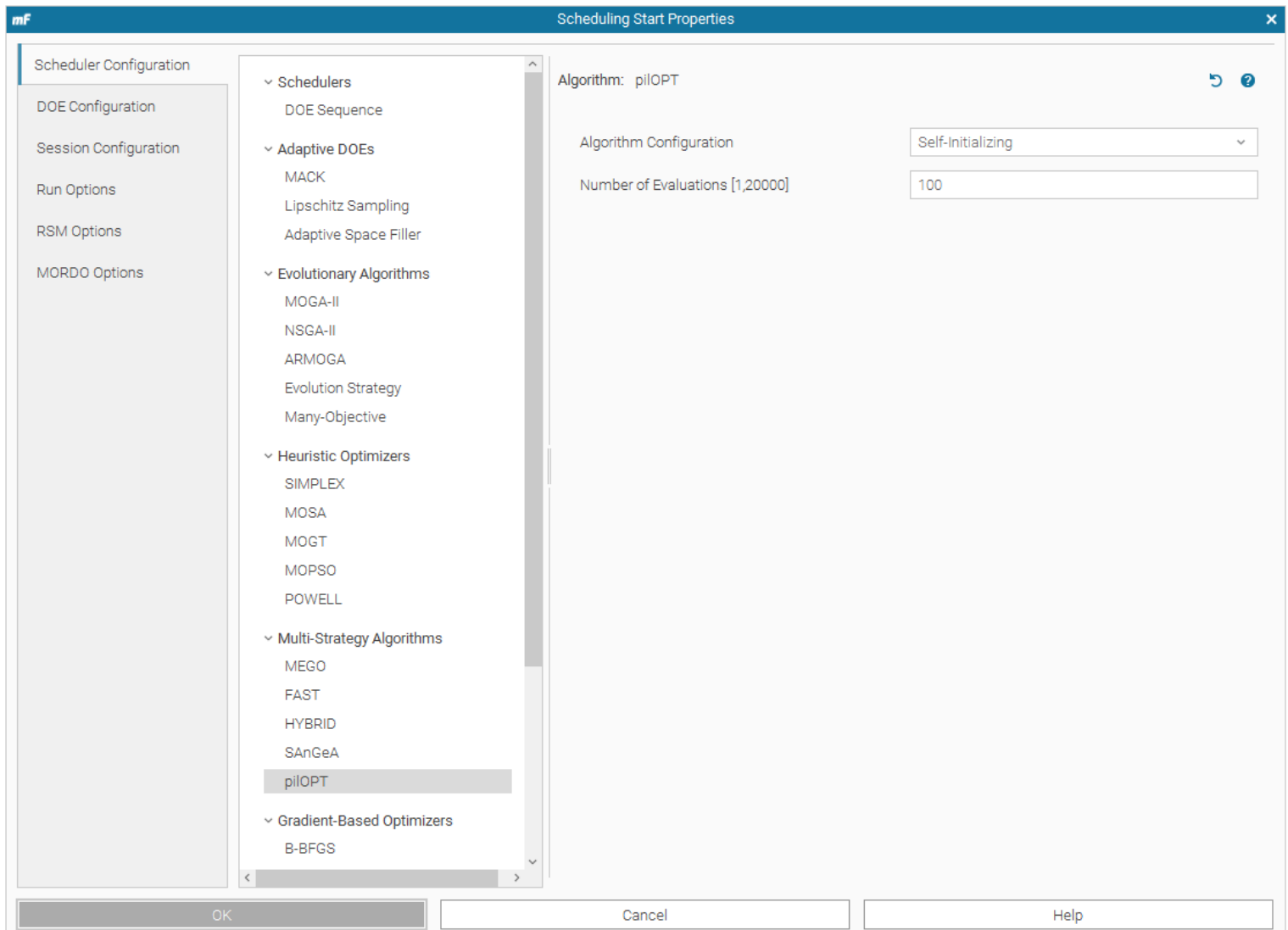

Figure 72 PiLOPT Setup

## PiLOPT Scheduler Config:



**Figure 131 PiLOPT Scheduler**

No DOE Table set on this scheduler. The Session table was set to point at the 84-row results table produced by the original DOE run. The run options are shown below:

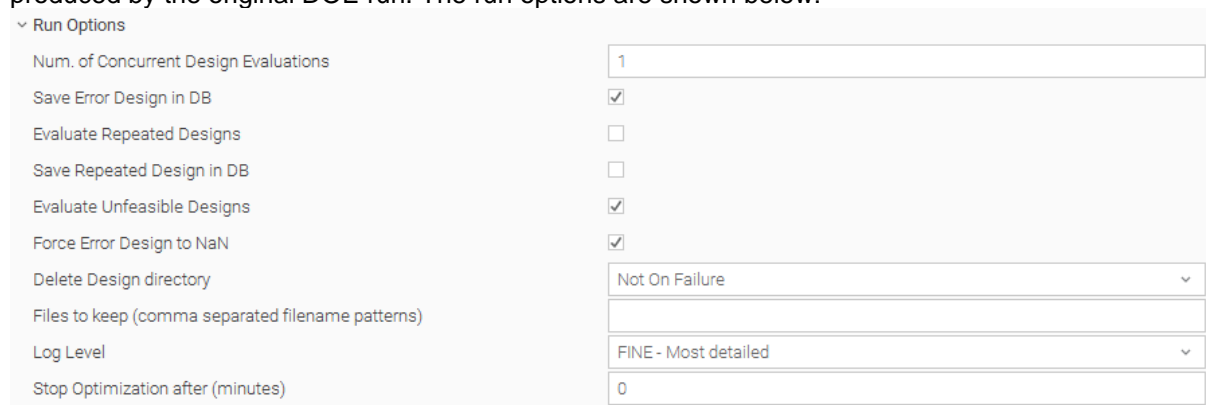

**Figure 74 PiLOPT Run Options**



## Levenberg-Marquardt Optimiser Build

Levenberg-Marquardt Workflow – Note, the change in flow around the PumpPowerCalc. This is due to the objective function needing a single variable input as opposed to a vector input from the DOE and piLOPT workflows. Other than this, all inputs and outputs remain the same, with only the scheduler being changed.

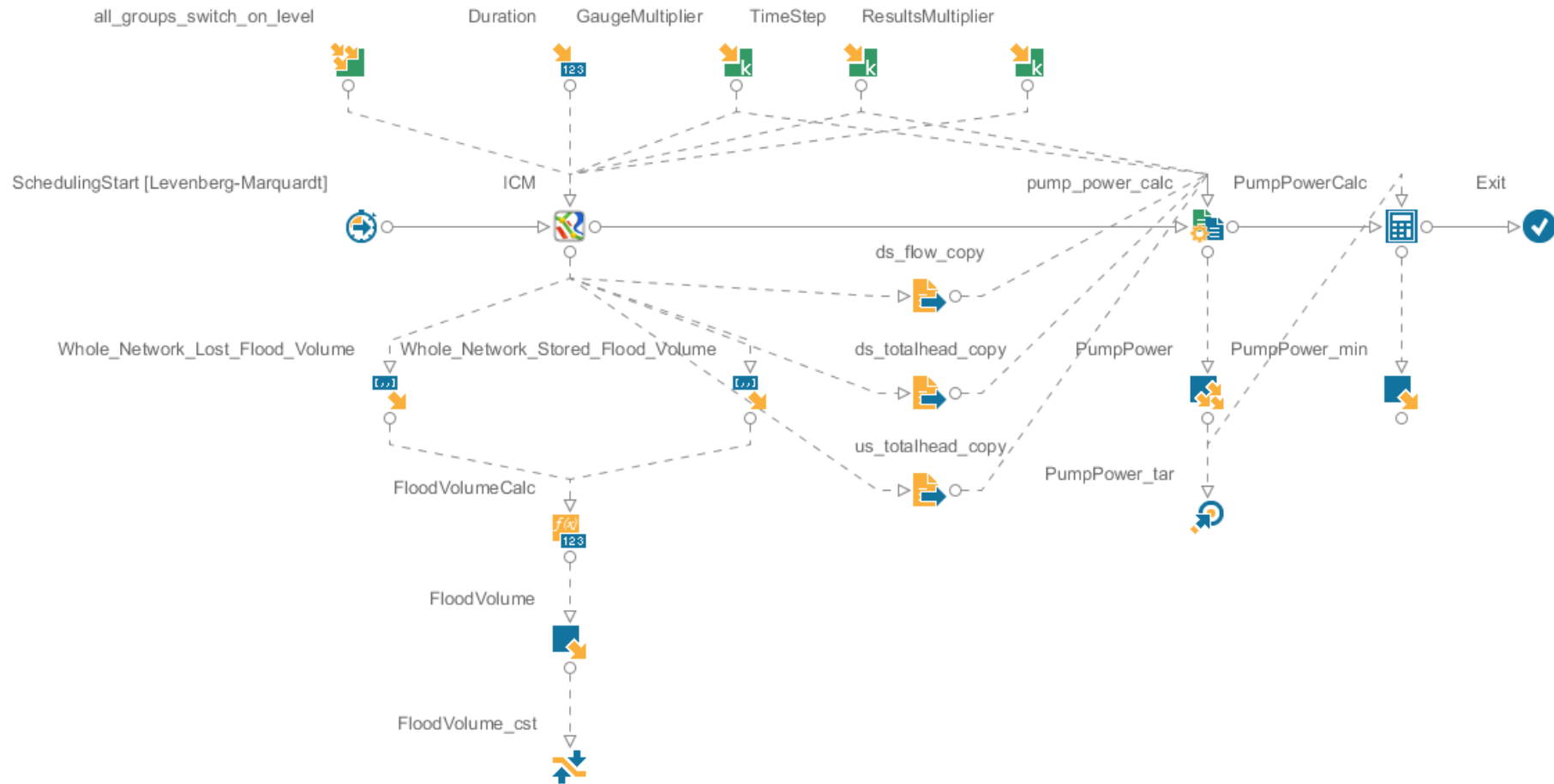

Figure 133 Levenberg-Marquardt Optimiser Workflow

## Levenberg-Marquardt Scheduler Properties

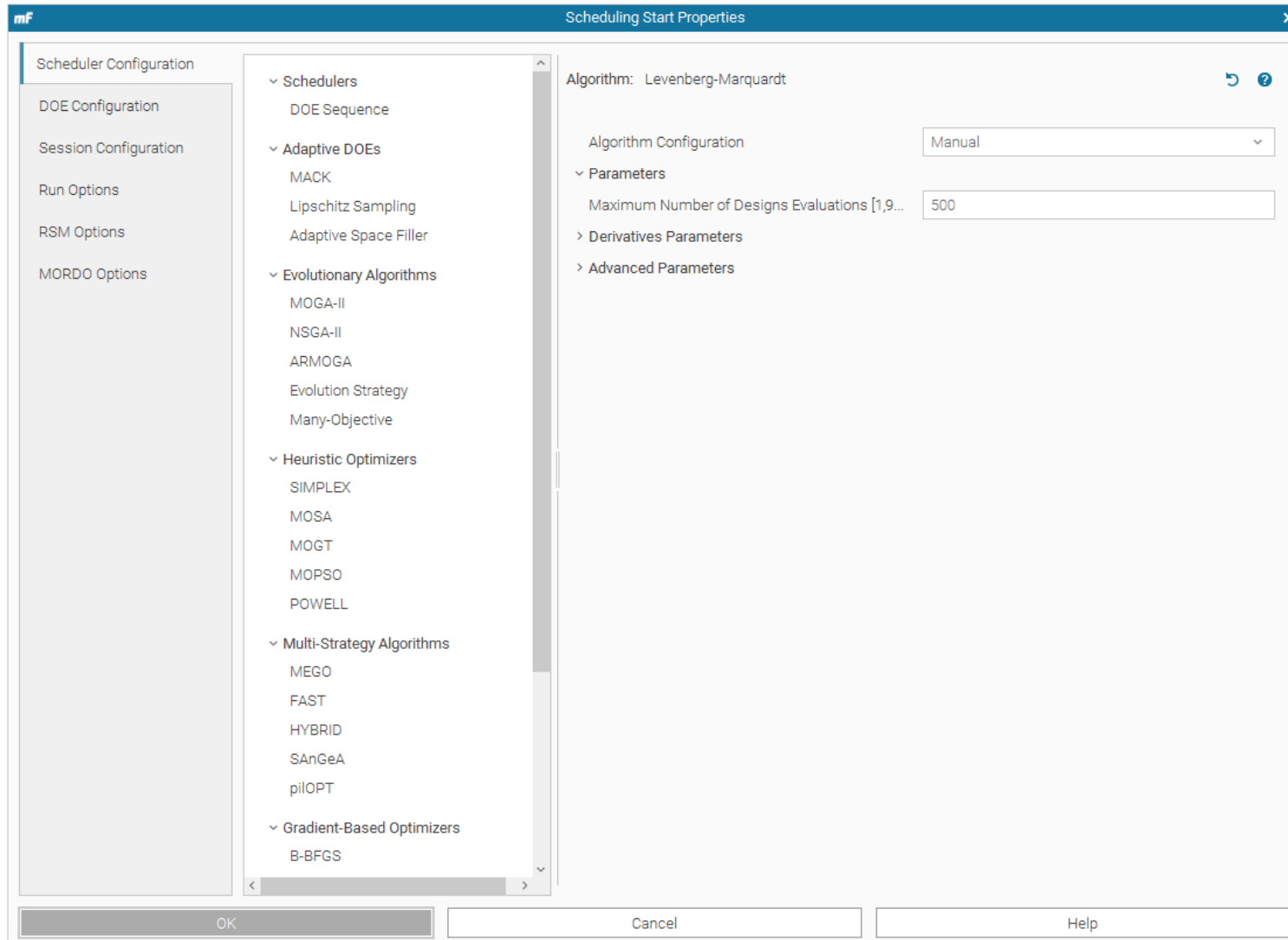
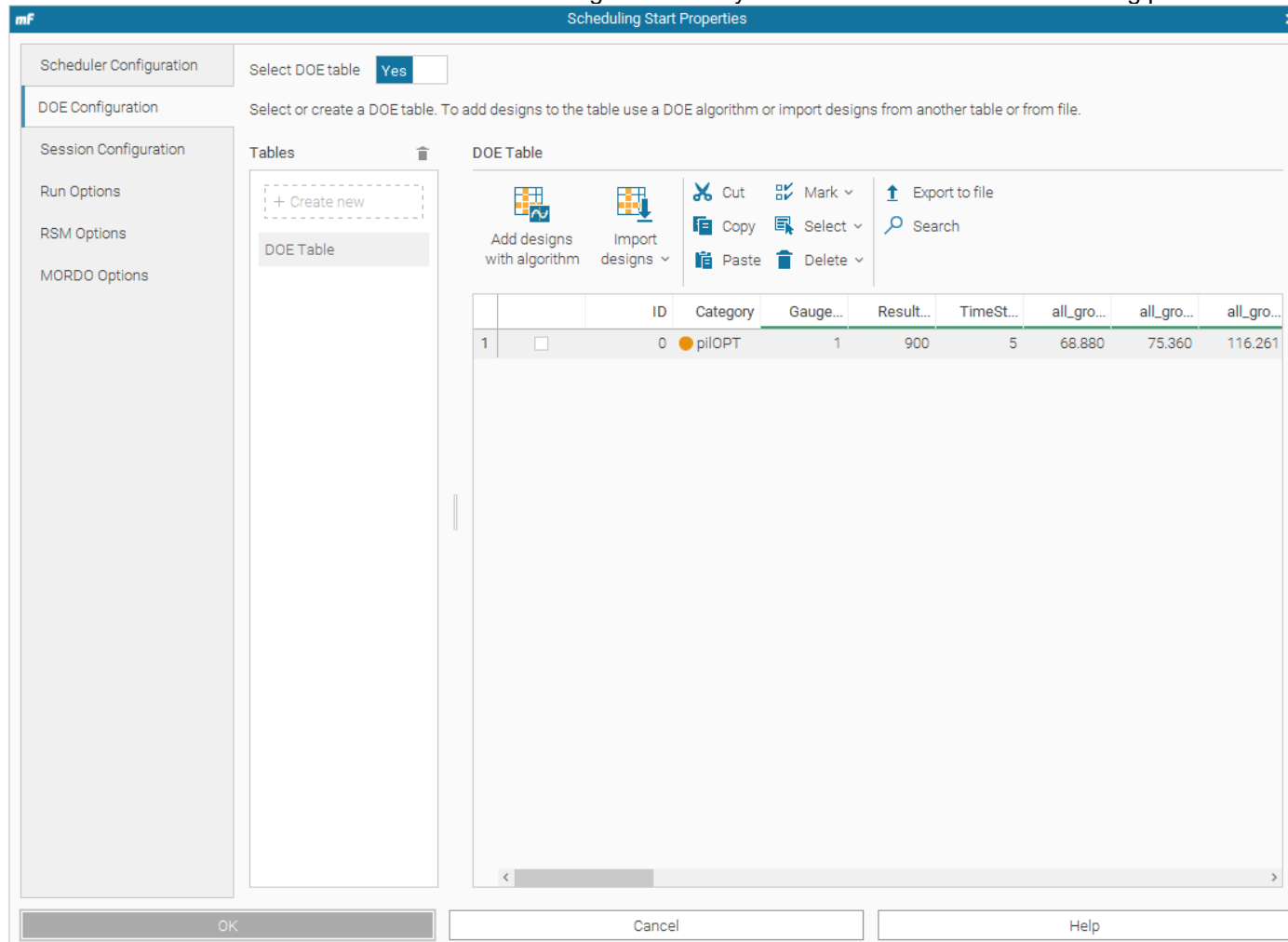

Figure 76 Levenberg-Marquardt Scheduler Properties

This optimiser used a DOE table and was set to look at the PiLOPT configuration that yielded the best results as its starting point.



**Figure 77 Levenberg-Marquardt DoE Setup**

Session Configuration: This was set to add results to the original 'DesignTable'

Run Options:

Run Options	
Num. of Concurrent Design Evaluations	<input type="text" value="1"/>
Save Error Design in DB	<input checked="" type="checkbox"/>
Evaluate Repeated Designs	<input type="checkbox"/>
Save Repeated Design in DB	<input type="checkbox"/>
Evaluate Unfeasible Designs	<input checked="" type="checkbox"/>
Force Error Design to NaN	<input checked="" type="checkbox"/>
Delete Design directory	<input type="text" value="Not On Failure"/>
Files to keep (comma separated filename patterns)	<input type="text"/>
Log Level	<input type="text" value="FINE - Most detailed"/>
Stop Optimization after (minutes)	<input type="text" value="0"/>

**Figure 78 Levenberg-Marquardt Run Options**

All Groups Switch On Levels: Excel - Levenberg-Marquardt All Groups Switch On Levels (This has some Pump Stations set to constant and some set to variable).

# NSGA-II Optimiser Build

NSGA-II Workflow – Note, this uses the same workflow setup as the Levenberg-Marquardt in terms of the pump power output

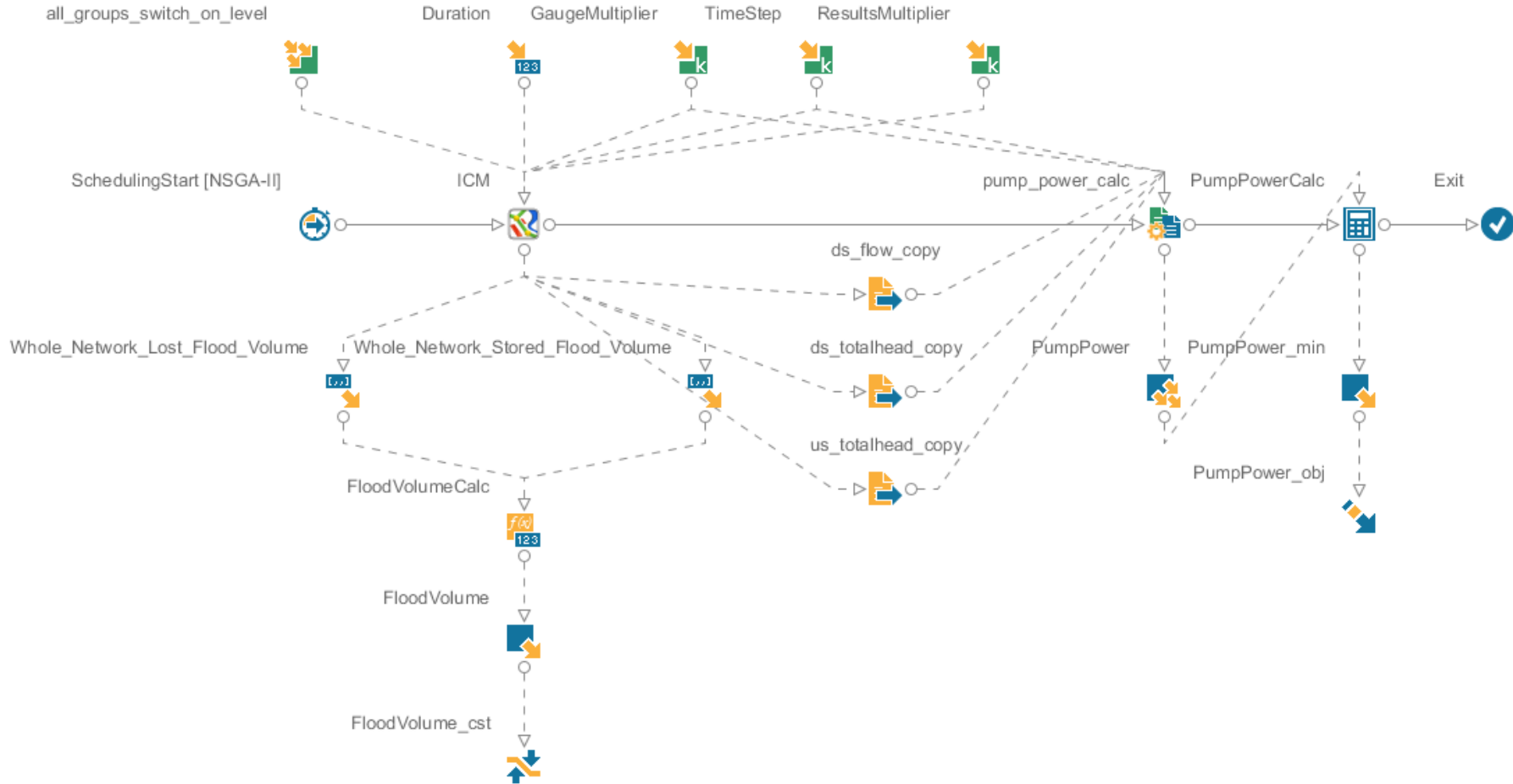

Figure 79 NSGA-II Workflow

Scheduling Start set to [NSGA-II]

Algorithm Configuration: Manual  
Number of evaluations: 100  
Algorithm Type: Steady State Evolution (MFGA)

Algorithm: NSGA-II

Algorithm Configuration: Manual

Parameters

Number of Evaluations [1,500000]: 100

Algorithm type: Steady State Evolution (MFGA)

GA Operators

Crossover Probability [0.0,1.0]: 0.9

Mutation Probability for Real-Co...: 1.0

Mutation Probability for Binary S...: 1.0

Advanced Parameters

Automatic Scaling for Mutation ...:

Distribution Index for Real-Code...: 20.0

Distribution Index for Real-Code...: 20.0

Crossover Type for Binary-Code...: Simple

Random Generator Seed [0,999]: 1

Category Parameters

Categorize Generations:

**Figure 80 NSGA-II Parameter Setup**

DOE Configuration: Set to yes, using DOETable2

Session Configuration: This was set to add results to the original 'DesignTable'

Run Options:

Run Options	
Num. of Concurrent Design Evaluations	<input type="text" value="1"/>
Save Error Design in DB	<input checked="" type="checkbox"/>
Evaluate Repeated Designs	<input type="checkbox"/>
Save Repeated Design in DB	<input type="checkbox"/>
Evaluate Unfeasible Designs	<input checked="" type="checkbox"/>
Force Error Design to NaN	<input checked="" type="checkbox"/>
Delete Design directory	<input type="text" value="Not On Failure"/>
Files to keep (comma separated filename patterns)	<input type="text"/>
Log Level	<input type="text" value="FINE - Most detailed"/>
Stop Optimization after (minutes)	<input type="text" value="0"/>

**Figure 139 NSGA-II Run Options**

All Groups Switch On Levels: Excel - NSGA-II All Groups Switch On Levels (This has some Pump Stations set to constant and some set to variable).

## Levenberg-Marquardt and NSGA-II PumpPower Calc

The screenshot shows the 'Calculator Properties' dialog box. The 'Name' field is 'PumpPowerCalc'. The 'Script File' is '[Embedded] javaScript.js'. Under 'Calculator Advanced Properties', 'Fast Launch by Process Fork' is checked. Under 'Statistics', 'Charset' is 'windows-1252', 'Line Separator' is 'UNIX (LF)', and 'Length' is '28'. The 'Process Input Connector' is 'pump\_power\_calc' with 'EXIT' selected. The 'Data Input Connector' is 'PumpPower'. The 'Process Output Connector' is 'Exit' with 'EXIT' selected. The 'Data Output Connector' is 'PumpPower\_min' with 'PumpPower\_min' selected.

**Figure 140 Levenberg-Marquardt and NSGA-II PumpPower Calc**

For the NSGA-II and Levenberg-Marquardt optimiser, the pump power output needed to be converted from a vector to an output variable. This is why there is a slight change to the workflow when compared to the previous workflows.

This block takes the 42length PumpPower vector and the pump\_power\_calc process input connector and uses a basic embedded Java script to convert the vector output of the 42 pump powers into the PumpPowerMin output variable.



### Vector to Output Variable Java Script

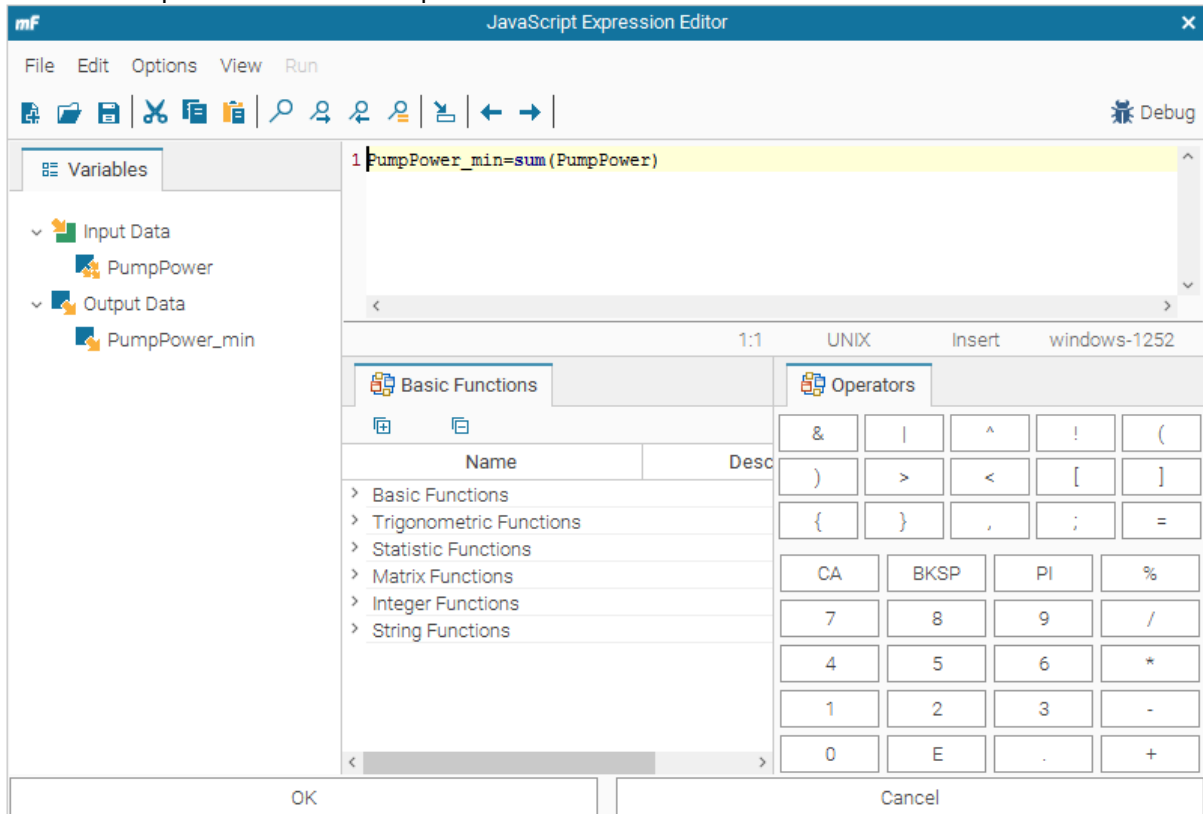

**Figure 83 Vector to Output Variable Java Script**

## PumpPower\_Min

The screenshot shows a software dialog box titled "Output Variable Properties" with a blue header bar containing the "mf" logo and a close button. The dialog is divided into several sections:

- Output Variable Properties:**
  - Name: PumpPower\_min
  - Description: (empty field with a help icon)
  - Format: 0.0000E0
- Reliability Properties:**
  - Percentiles (%) [0.0,100.0]: (empty field with a help icon)
  - Percentile Sample Size [1000,1000000]: 1000
- Data Input Connector:** PumpPowerCalc
- Data Output Connector:** PumpPower\_obj

At the bottom, there are three buttons: "OK", "Cancel", and "Help".

**Figure 84 Pump Power Minimum**

This block assembles the output value from the Pump Power Min calculation into a format for the objective function to operate from. (Format 0.000)

The objective function:

The screenshot shows the 'Objective Properties' dialog box. The title bar contains 'mF' and 'Objective Properties'. The dialog is organized into three main sections:

- Objective Properties:**
  - Name: PumpPower\_obj
  - Description: (empty)
  - Enabled:
  - Format: 0.00
- Objective Expression Properties:**
  - User Expression: PumpPower\_min
  - Type: Minimize
- Data Input Connector:**
  - PumpPower\_min

At the bottom of the dialog are three buttons: 'OK', 'Cancel', and 'Help'.

**Figure 85 Objective Function**

This block takes the input connector from the PumpPower\_min, which is the summated vector of all pump powers into one output variable. It then applies the objective function which is to minimize this value.

**Optimisation of Water Companies Waste  
Pumping Asset Base with a Focus on Energy  
Reduction**

**Appendix 6 – Results Table**

**Alex Gray**

**2022**

***College of Engineering, Design and Physical  
Sciences Brunel University London***

```

#--- Frontier Design DB File Info -----
#modeFRONTIER - (c) ESTECO S.p.A.
#Design DB Table
#-----
#modeFRONTIER Version: modeFRONTIER 2019R2 6.5.0.2 b20190626
#Date: Sun Dec 08 13:18:05 GMT 2019
#Project Name: Final Project.prj
#Operating System: Windows Server 2012 R2 6.3 amd64
#Java (SDK/JRE) Version: 1.8.0_172
#Java Vendor: Oracle Corporation
#Java Vendor URL: http://java.oracle.com/
#User Name: Administrator
#-----
#Categories
<CATEGORIES clusterPrefix="CLUSTER_" useTableNamePrefix="false">
<CATEGORY enabled="true" label="" name="DOE"
symbolc="CIRCLE,NONE,11,#000080,1,#000080"/>
<CATEGORY enabled="true" label="" name="pilOPT"
symbolc="CIRCLE,NONE,11,#E5910D,1,#E5910D"/>
<CATEGORY enabled="true" label="" name="LOADED"
symbolc="CIRCLE,NONE,11,#B3271C,1,#B3271C"/>
<CATEGORY enabled="true" label="" name="Baseline" symbolc="X,NONE,14,#FF0000,1,#31874E"/>
<CATEGORY enabled="true" label="" name="ULH"
symbolc="CIRCLE,NONE,11,#1E5A80,1,#1E5A80"/>
<CATEGORY enabled="true" label="" name="LM_DERIV"
symbolc="CIRCLE,NONE,11,#31874E,1,#31874E"/>
<CATEGORY enabled="true" label="" name="LM" symbolc="CIRCLE,NONE,11,#424242,1,#424242"/>
<CATEGORY enabled="true" label="" name="DOE_APPROX"
symbolc="CIRCLE,NONE,11,#67A5C1,1,#67A5C1"/>
</CATEGORIES>
#-----
e DOE_APPROX

```

<ID>	GaugeMultiplier	ResultsMultiplier	TimeStep	all_groups_switch_on_level[0]
0	1.00	900.00	5.00	72.46
1	1.00	900.00	5.00	70.13
2	1.00	900.00	5.00	71.52
3	1.00	900.00	5.00	71.14
4	1.00	900.00	5.00	69.48
5	1.00	900.00	5.00	71.77
6	1.00	900.00	5.00	69.80
7	1.00	900.00	5.00	70.57
8	1.00	900.00	5.00	72.08
9	1.00	900.00	5.00	72.51
10	1.00	900.00	5.00	69.54
11	1.00	900.00	5.00	71.67
12	1.00	900.00	5.00	70.70
13	1.00	900.00	5.00	70.66
14	1.00	900.00	5.00	68.92

15	1.00	900.00	5.00	71.42
16	1.00	900.00	5.00	70.34
17	1.00	900.00	5.00	68.99
18	1.00	900.00	5.00	69.88
19	1.00	900.00	5.00	72.55
20	1.00	900.00	5.00	70.20
21	1.00	900.00	5.00	70.48
22	1.00	900.00	5.00	69.69
23	1.00	900.00	5.00	70.46
24	1.00	900.00	5.00	72.36
25	1.00	900.00	5.00	71.19
26	1.00	900.00	5.00	69.16
27	1.00	900.00	5.00	69.61
28	1.00	900.00	5.00	69.30
29	1.00	900.00	5.00	71.30
30	1.00	900.00	5.00	70.06
31	1.00	900.00	5.00	71.04
32	1.00	900.00	5.00	69.90
33	1.00	900.00	5.00	69.51
34	1.00	900.00	5.00	71.62
35	1.00	900.00	5.00	70.81
36	1.00	900.00	5.00	71.87
37	1.00	900.00	5.00	72.41
38	1.00	900.00	5.00	69.85
39	1.00	900.00	5.00	70.88
40	1.00	900.00	5.00	70.76
41	1.00	900.00	5.00	70.10
42	1.00	900.00	5.00	72.23
43	1.00	900.00	5.00	69.99
44	1.00	900.00	5.00	69.73
45	1.00	900.00	5.00	69.26
46	1.00	900.00	5.00	71.90
47	1.00	900.00	5.00	70.39
48	1.00	900.00	5.00	72.02
49	1.00	900.00	5.00	70.94
50	1.00	900.00	5.00	71.00
51	1.00	900.00	5.00	72.13
52	1.00	900.00	5.00	69.35
53	1.00	900.00	5.00	72.20
54	1.00	900.00	5.00	70.28
55	1.00	900.00	5.00	69.43
56	1.00	900.00	5.00	71.08
57	1.00	900.00	5.00	70.54
58	1.00	900.00	5.00	68.84

59	1.00	900.00	5.00	69.08
60	1.00	900.00	5.00	71.95
61	1.00	900.00	5.00	71.12
62	1.00	900.00	5.00	72.28
63	1.00	900.00	5.00	71.34
64	1.00	900.00	5.00	69.14
65	1.00	900.00	5.00	71.55
66	1.00	900.00	5.00	69.21
67	1.00	900.00	5.00	71.36
68	1.00	900.00	5.00	71.23
69	1.00	900.00	5.00	69.03
70	1.00	900.00	5.00	71.70
71	1.00	900.00	5.00	69.98
72	1.00	900.00	5.00	70.22
73	1.00	900.00	5.00	68.91
74	1.00	900.00	5.00	71.48
75	1.00	900.00	5.00	71.74
76	1.00	900.00	5.00	71.82
77	1.00	900.00	5.00	70.87
78	1.00	900.00	5.00	70.64
79	1.00	900.00	5.00	69.39
80	1.00	900.00	5.00	72.06
81	1.00	900.00	5.00	72.31
82	1.00	900.00	5.00	69.66
83	1.00	900.00	5.00	70.34
84	1.00	900.00	5.00	72.56
85	1.00	900.00	5.00	70.29
86	1.00	900.00	5.00	68.83
87	1.00	900.00	5.00	68.84
88	1.00	900.00	5.00	68.84
89	1.00	900.00	5.00	72.56
90	1.00	900.00	5.00	68.83
91	1.00	900.00	5.00	70.70
92	1.00	900.00	5.00	70.04
93	1.00	900.00	5.00	72.56
94	1.00	900.00	5.00	68.83
95	1.00	900.00	5.00	72.56
96	1.00	900.00	5.00	71.82
97	1.00	900.00	5.00	68.83
98	1.00	900.00	5.00	70.51
99	1.00	900.00	5.00	68.83
100	1.00	900.00	5.00	70.63
101	1.00	900.00	5.00	70.70
102	1.00	900.00	5.00	68.83

103	1.00	900.00	5.00	68.83
104	1.00	900.00	5.00	68.83
105	1.00	900.00	5.00	70.70
106	1.00	900.00	5.00	68.87
107	1.00	900.00	5.00	70.70
108	1.00	900.00	5.00	69.47
109	1.00	900.00	5.00	68.83
110	1.00	900.00	5.00	71.63
111	1.00	900.00	5.00	69.88
112	1.00	900.00	5.00	69.76
113	1.00	900.00	5.00	70.63
114	1.00	900.00	5.00	69.76
115	1.00	900.00	5.00	72.56
116	1.00	900.00	5.00	69.76
117	1.00	900.00	5.00	72.55
118	1.00	900.00	5.00	72.56
119	1.00	900.00	5.00	70.63
120	1.00	900.00	5.00	68.83
121	1.00	900.00	5.00	70.63
122	1.00	900.00	5.00	71.63
123	1.00	900.00	5.00	70.78
124	1.00	900.00	5.00	69.76
125	1.00	900.00	5.00	70.29
126	1.00	900.00	5.00	72.56
127	1.00	900.00	5.00	68.83
128	1.00	900.00	5.00	69.76
129	1.00	900.00	5.00	70.41
130	1.00	900.00	5.00	68.83
131	1.00	900.00	5.00	71.40
132	1.00	900.00	5.00	69.54
133	1.00	900.00	5.00	72.46
134	1.00	900.00	5.00	69.80
135	1.00	900.00	5.00	69.81
136	1.00	900.00	5.00	72.56
137	1.00	900.00	5.00	70.54
138	1.00	900.00	5.00	72.56
139	1.00	900.00	5.00	68.88
140	1.00	900.00	5.00	69.80
141	1.00	900.00	5.00	69.81
142	1.00	900.00	5.00	69.80
143	1.00	900.00	5.00	71.09
144	1.00	900.00	5.00	69.80
145	1.00	900.00	5.00	68.88
146	1.00	900.00	5.00	71.64



147	1.00	900.00	5.00	68.88
148	1.00	900.00	5.00	69.80
149	1.00	900.00	5.00	69.43
150	1.00	900.00	5.00	72.56
151	1.00	900.00	5.00	68.98
152	1.00	900.00	5.00	72.56
153	1.00	900.00	5.00	69.25
154	1.00	900.00	5.00	70.72
155	1.00	900.00	5.00	69.62
156	1.00	900.00	5.00	72.56
157	1.00	900.00	5.00	70.63
158	1.00	900.00	5.00	68.88
159	1.00	900.00	5.00	69.43
160	1.00	900.00	5.00	72.43
161	1.00	900.00	5.00	69.09
162	1.00	900.00	5.00	70.05
163	1.00	900.00	5.00	68.88
164	1.00	900.00	5.00	68.88
165	1.00	900.00	5.00	69.54
166	1.00	900.00	5.00	72.56
167	1.00	900.00	5.00	69.08
168	1.00	900.00	5.00	69.80
169	1.00	900.00	5.00	68.88
170	1.00	900.00	5.00	69.80
171	1.00	900.00	5.00	69.54
172	1.00	900.00	5.00	69.80
173	1.00	900.00	5.00	71.43
174	1.00	900.00	5.00	68.88
175	1.00	900.00	5.00	68.88
176	1.00	900.00	5.00	68.88
177	1.00	900.00	5.00	69.26
178	1.00	900.00	5.00	68.88
179	1.00	900.00	5.00	68.88
180	1.00	900.00	5.00	69.80
181	1.00	900.00	5.00	69.80
182	1.00	900.00	5.00	69.80
183	1.00	900.00	5.00	69.80
184	1.00	900.00	5.00	69.80
185	1.00	900.00	5.00	68.88
186	1.00	900.00	5.00	68.88
187	1.00	900.00	5.00	68.88
188	1.00	900.00	5.00	68.88
189	1.00	900.00	5.00	68.88
190	1.00	900.00	5.00	70.68

191	1.00	900.00	5.00	69.20
192	1.00	900.00	5.00	70.75
193	1.00	900.00	5.00	70.06
194	1.00	900.00	5.00	68.88
195	1.00	900.00	5.00	68.90
196	1.00	900.00	5.00	69.10
197	1.00	900.00	5.00	68.88
198	1.00	900.00	5.00	69.57
199	1.00	900.00	5.00	68.88
200	1.00	900.00	5.00	68.88
201	1.00	900.00	5.00	68.88
202	1.00	900.00	5.00	68.88
203	1.00	900.00	5.00	68.88
204	1.00	900.00	5.00	68.88
205	1.00	900.00	5.00	68.88
206	1.00	900.00	5.00	68.88
207	1.00	900.00	5.00	68.88
208	1.00	900.00	5.00	68.88
209	1.00	900.00	5.00	68.88
210	1.00	900.00	5.00	68.95
211	1.00	900.00	5.00	68.88
212	1.00	900.00	5.00	68.88
213	1.00	900.00	5.00	68.88
214	1.00	900.00	5.00	68.88
215	1.00	900.00	5.00	68.88
216	1.00	900.00	5.00	68.88
217	1.00	900.00	5.00	68.88
218	1.00	900.00	5.00	68.88
219	1.00	900.00	5.00	68.88
220	1.00	900.00	5.00	68.88
221	1.00	900.00	5.00	68.88
222	1.00	900.00	5.00	68.88
223	1.00	900.00	5.00	68.88
224	1.00	900.00	5.00	68.88
225	1.00	900.00	5.00	68.88
226	1.00	900.00	5.00	68.88
227	1.00	900.00	5.00	68.88
228	1.00	900.00	5.00	68.88
229	1.00	900.00	5.00	68.88
230	1.00	900.00	5.00	68.88
231	1.00	900.00	5.00	68.88
232	1.00	900.00	5.00	68.88
233	1.00	900.00	5.00	68.88
234	1.00	900.00	5.00	68.88

235	1.00	900.00	5.00	68.88
236	1.00	900.00	5.00	68.88
237	1.00	900.00	5.00	68.88
238	1.00	900.00	5.00	68.88
239	1.00	900.00	5.00	68.88
240	1.00	900.00	5.00	68.88
241	1.00	900.00	5.00	68.88
242	1.00	900.00	5.00	68.88
243	1.00	900.00	5.00	68.88
244	1.00	900.00	5.00	68.88
245	1.00	900.00	5.00	68.88
246	1.00	900.00	5.00	68.88
247	1.00	900.00	5.00	68.88
248	1.00	900.00	5.00	68.88
249	1.00	900.00	5.00	68.88
250	1.00	900.00	5.00	68.88
251	1.00	900.00	5.00	68.88
252	1.00	900.00	5.00	68.88
253	1.00	900.00	5.00	68.88
254	1.00	900.00	5.00	68.88
255	1.00	900.00	5.00	68.88
256	1.00	900.00	5.00	68.88
257	1.00	900.00	5.00	69.12
258	1.00	900.00	5.00	68.97
259	1.00	900.00	5.00	68.89
260	1.00	900.00	5.00	68.88
261	1.00	900.00	5.00	68.88
262	1.00	900.00	5.00	68.95
263	1.00	900.00	5.00	68.88
264	1.00	900.00	5.00	68.88
265	1.00	900.00	5.00	68.88
266	1.00	900.00	5.00	68.88
267	1.00	900.00	5.00	68.88
268	1.00	900.00	5.00	68.88
269	1.00	900.00	5.00	68.88
270	1.00	900.00	5.00	68.88
271	1.00	900.00	5.00	68.88
272	1.00	900.00	5.00	68.88
273	1.00	900.00	5.00	68.88
274	1.00	900.00	5.00	68.88
275	1.00	900.00	5.00	68.88
276	1.00	900.00	5.00	68.88
277	1.00	900.00	5.00	68.88
278	1.00	900.00	5.00	68.88

279	1.00	900.00	5.00	68.88
280	1.00	900.00	5.00	68.88
281	1.00	900.00	5.00	68.88
282	1.00	900.00	5.00	68.88
283	1.00	900.00	5.00	68.88
284	1.00	900.00	5.00	68.88
285	1.00	900.00	5.00	68.88
286	1.00	900.00	5.00	68.88
287	1.00	900.00	5.00	68.88
288	1.00	900.00	5.00	68.88
289	1.00	900.00	5.00	68.88
290	1.00	900.00	5.00	68.88
291	1.00	900.00	5.00	68.88
292	1.00	900.00	5.00	68.88
293	1.00	900.00	5.00	68.88
294	1.00	900.00	5.00	68.88
295	1.00	900.00	5.00	68.88
296	1.00	900.00	5.00	68.88
297	1.00	900.00	5.00	68.88
298	1.00	900.00	5.00	68.88
299	1.00	900.00	5.00	68.88
300	1.00	900.00	5.00	68.88
301	1.00	900.00	5.00	68.88
302	1.00	900.00	5.00	68.88
303	1.00	900.00	5.00	68.88
304	1.00	900.00	5.00	68.88
305	1.00	900.00	5.00	68.88
306	1.00	900.00	5.00	68.95
307	1.00	900.00	5.00	68.88
308	1.00	900.00	5.00	68.88
309	1.00	900.00	5.00	68.88
310	1.00	900.00	5.00	68.88
311	1.00	900.00	5.00	68.88
312	1.00	900.00	5.00	68.88
313	1.00	900.00	5.00	68.88
314	1.00	900.00	5.00	68.88
315	1.00	900.00	5.00	68.88
316	1.00	900.00	5.00	68.88
317	1.00	900.00	5.00	68.88
318	1.00	900.00	5.00	68.88
319	1.00	900.00	5.00	68.88
320	1.00	900.00	5.00	68.88
321	1.00	900.00	5.00	68.88
322	1.00	900.00	5.00	68.88

323	1.00	900.00	5.00	68.88
324	1.00	900.00	5.00	68.88
325	1.00	900.00	5.00	68.88
326	1.00	900.00	5.00	68.88
327	1.00	900.00	5.00	68.88
328	1.00	900.00	5.00	68.88
329	1.00	900.00	5.00	68.88
330	1.00	900.00	5.00	68.88
331	1.00	900.00	5.00	68.88
332	1.00	900.00	5.00	68.88
333	1.00	900.00	5.00	68.88
334	1.00	900.00	5.00	68.88
335	1.00	900.00	5.00	68.88
336	1.00	900.00	5.00	68.88
337	1.00	900.00	5.00	68.88
338	1.00	900.00	5.00	68.88
339	1.00	900.00	5.00	68.88
340	1.00	900.00	5.00	68.88
341	1.00	900.00	5.00	68.88
342	1.00	900.00	5.00	68.88
343	1.00	900.00	5.00	68.88
344	1.00	900.00	5.00	68.88
345	1.00	900.00	5.00	68.88
346	1.00	900.00	5.00	68.88
347	1.00	900.00	5.00	68.88
348	1.00	900.00	5.00	68.89
349	1.00	900.00	5.00	68.88
350	1.00	900.00	5.00	68.88
351	1.00	900.00	5.00	68.88
352	1.00	900.00	5.00	68.95
353	1.00	900.00	5.00	68.88
354	1.00	900.00	5.00	68.88
355	1.00	900.00	5.00	68.88
356	1.00	900.00	5.00	68.88
357	1.00	900.00	5.00	68.88
358	1.00	900.00	5.00	68.88
359	1.00	900.00	5.00	68.88
360	1.00	900.00	5.00	68.88
361	1.00	900.00	5.00	68.88
362	1.00	900.00	5.00	68.88
363	1.00	900.00	5.00	68.88
364	1.00	900.00	5.00	68.88
365	1.00	900.00	5.00	68.88
366	1.00	900.00	5.00	68.88

367	1.00	900.00	5.00	68.88
368	1.00	900.00	5.00	68.88
369	1.00	900.00	5.00	68.88
370	1.00	900.00	5.00	68.88
371	1.00	900.00	5.00	68.88
372	1.00	900.00	5.00	68.88
373	1.00	900.00	5.00	68.88
374	1.00	900.00	5.00	68.88
375	1.00	900.00	5.00	68.88
376	1.00	900.00	5.00	68.88
377	1.00	900.00	5.00	68.88
378	1.00	900.00	5.00	68.88
379	1.00	900.00	5.00	68.88
380	1.00	900.00	5.00	68.88
381	1.00	900.00	5.00	68.88
382	1.00	900.00	5.00	68.88
383	1.00	900.00	5.00	68.88
384	1.00	900.00	5.00	68.88
385	1.00	900.00	5.00	68.88
386	1.00	900.00	5.00	68.88
387	1.00	900.00	5.00	68.88
388	1.00	900.00	5.00	68.88
389	1.00	900.00	5.00	68.88
390	1.00	900.00	5.00	68.88
391	1.00	900.00	5.00	68.88
392	1.00	900.00	5.00	68.88
393	1.00	900.00	5.00	68.88
394	1.00	900.00	5.00	68.88
395	1.00	900.00	5.00	68.88
396	1.00	900.00	5.00	68.88
397	1.00	900.00	5.00	69.12
398	1.00	900.00	5.00	68.88
399	1.00	900.00	5.00	68.88
400	1.00	900.00	5.00	68.88
401	1.00	900.00	5.00	68.88
402	1.00	900.00	5.00	68.88
403	1.00	900.00	5.00	68.95
404	1.00	900.00	5.00	68.88
405	1.00	900.00	5.00	68.88
406	1.00	900.00	5.00	68.88
407	1.00	900.00	5.00	68.88
408	1.00	900.00	5.00	68.88
409	1.00	900.00	5.00	68.88
410	1.00	900.00	5.00	68.88

411	1.00	900.00	5.00	68.88
412	1.00	900.00	5.00	68.88
413	1.00	900.00	5.00	68.88
414	1.00	900.00	5.00	68.88
415	1.00	900.00	5.00	68.88
416	1.00	900.00	5.00	68.88
417	1.00	900.00	5.00	68.88
418	1.00	900.00	5.00	68.88
419	1.00	900.00	5.00	68.88
420	1.00	900.00	5.00	68.88
421	1.00	900.00	5.00	68.88
422	1.00	900.00	5.00	68.88
423	1.00	900.00	5.00	68.88
424	1.00	900.00	5.00	68.88
425	1.00	900.00	5.00	68.88
426	1.00	900.00	5.00	68.88
427	1.00	900.00	5.00	68.88
428	1.00	900.00	5.00	68.88
429	1.00	900.00	5.00	68.88
430	1.00	900.00	5.00	68.88
431	1.00	900.00	5.00	68.88
432	1.00	900.00	5.00	68.88
433	1.00	900.00	5.00	68.88
434	1.00	900.00	5.00	68.88
435	1.00	900.00	5.00	68.88
436	1.00	900.00	5.00	68.88
437	1.00	900.00	5.00	68.88
438	1.00	900.00	5.00	68.88
439	1.00	900.00	5.00	68.88
440	1.00	900.00	5.00	68.88
441	1.00	900.00	5.00	68.88
442	1.00	900.00	5.00	68.88
443	1.00	900.00	5.00	68.88
444	1.00	900.00	5.00	68.88
445	1.00	900.00	5.00	68.88
446	1.00	900.00	5.00	68.88
447	1.00	900.00	5.00	68.88
448	1.00	900.00	5.00	68.88
449	1.00	900.00	5.00	68.88
450	1.00	900.00	5.00	68.88
451	1.00	900.00	5.00	68.88
452	1.00	900.00	5.00	68.88
453	1.00	900.00	5.00	68.88
454	1.00	900.00	5.00	68.88

455	1.00	900.00	5.00	68.88
456	1.00	900.00	5.00	68.88
457	1.00	900.00	5.00	68.88
458	1.00	900.00	5.00	68.88
459	1.00	900.00	5.00	68.88
460	1.00	900.00	5.00	68.88
461	1.00	900.00	5.00	68.88
462	1.00	900.00	5.00	68.88
463	1.00	900.00	5.00	68.88
464	1.00	900.00	5.00	68.88
465	1.00	900.00	5.00	68.88
466	1.00	900.00	5.00	68.88
467	1.00	900.00	5.00	68.88
468	1.00	900.00	5.00	68.88
469	1.00	900.00	5.00	68.88
470	1.00	900.00	5.00	68.88
471	1.00	900.00	5.00	68.88
472	1.00	900.00	5.00	68.88
473	1.00	900.00	5.00	68.88
474	1.00	900.00	5.00	68.88
475	1.00	900.00	5.00	68.88
476	1.00	900.00	5.00	68.88
477	1.00	900.00	5.00	68.88
478	1.00	900.00	5.00	68.88
479	1.00	900.00	5.00	68.88
480	1.00	900.00	5.00	68.88
481	1.00	900.00	5.00	68.88
482	1.00	900.00	5.00	68.88
483	1.00	900.00	5.00	68.88
484	1.00	900.00	5.00	68.88
485	1.00	900.00	5.00	68.88
486	1.00	900.00	5.00	68.88
487	1.00	900.00	5.00	68.88
488	1.00	900.00	5.00	68.88
489	1.00	900.00	5.00	68.88
490	1.00	900.00	5.00	68.88
491	1.00	900.00	5.00	68.88
492	1.00	900.00	5.00	68.88
493	1.00	900.00	5.00	68.88
494	1.00	900.00	5.00	68.88
495	1.00	900.00	5.00	68.88
496	1.00	900.00	5.00	68.88
497	1.00	900.00	5.00	68.88
498	1.00	900.00	5.00	68.88



499	1.00	900.00	5.00	68.88
500	1.00	900.00	5.00	68.88
501	1.00	900.00	5.00	68.88
502	1.00	900.00	5.00	68.88
503	1.00	900.00	5.00	68.88
504	1.00	900.00	5.00	68.88
505	1.00	900.00	5.00	68.88
506	1.00	900.00	5.00	68.88
507	1.00	900.00	5.00	68.88
508	1.00	900.00	5.00	68.88
509	1.00	900.00	5.00	68.88
510	1.00	900.00	5.00	68.88
511	1.00	900.00	5.00	68.88
512	1.00	900.00	5.00	68.88
513	1.00	900.00	5.00	68.88
514	1.00	900.00	5.00	68.88
515	1.00	900.00	5.00	68.88
516	1.00	900.00	5.00	68.88
517	1.00	900.00	5.00	68.88
518	1.00	900.00	5.00	68.88
519	1.00	900.00	5.00	68.88
520	1.00	900.00	5.00	68.88
521	1.00	900.00	5.00	68.88
522	1.00	900.00	5.00	68.88
523	1.00	900.00	5.00	68.88
524	1.00	900.00	5.00	68.88
525	1.00	900.00	5.00	68.88
526	1.00	900.00	5.00	68.88
527	1.00	900.00	5.00	68.88
528	1.00	900.00	5.00	68.88
529	1.00	900.00	5.00	68.88
530	1.00	900.00	5.00	68.88
531	1.00	900.00	5.00	68.88
532	1.00	900.00	5.00	68.88
533	1.00	900.00	5.00	68.88
534	1.00	900.00	5.00	68.88
535	1.00	900.00	5.00	68.88
536	1.00	900.00	5.00	68.88
537	1.00	900.00	5.00	68.88
538	1.00	900.00	5.00	68.88
539	1.00	900.00	5.00	68.88
540	1.00	900.00	5.00	68.88
541	1.00	900.00	5.00	68.88